

		<u>p.m.f.</u>	<u>width</u>	<u>amplitude</u>
<u>VT28 c</u>	Waveform as VT25 c	= 200 kHz,	= 800 nS	= 3.7V
<u>D26 a</u>	Waveform as VT25 c	= 200 kHz	= 700 nS	= 2.5V
<u>VT31 c</u>	Waveform as VT25 c	= 50 kHz	= 3 μ S	= 3.7V
<u>D28 a</u>	Waveform as VT25 c	= 50 kHz	= 3 μ S	= 2.5V
<u>VT34 c</u>	Waveform as VT25 c	= 10 kHz	= 12 μ S	= 3.7V
<u>D30 a</u>	Waveform as VT25 c	= 10 kHz	= 12 μ S	= 2.6V
<u>VT37 c</u>	Waveform as VT25 c	= 2 kHz	= 70 μ S	= 3.5V
<u>D32 a</u>	Waveform as VT25 c	= 2 kHz	= 70 μ S	= 2.3V

LG1 pin 2  p.r.f. = 2 kHz, width = 70 μ S
amplitude = 1.7V

LG1 pin 10  square 1 kHz amplitude = 2.4V

LG1 pin 6 Same as pin 10 but inverted.

Pin 24 With 50 Ω load fitted; 150 mV r.m.s., sinusoidal, 10.7 MHz

VT40 c With 50 Ω load fitted on pin 24; 4V p.p., sinusoidal, 10.7 MHz

VT45 c  p.r.f. = 50 kHz, width 50 nS
amplitude = 3.6V

VT46 c  p.r.f. = 50 kHz, width 80 nS
amplitude = 3.6V

Pin 30  p.r.f. 1 kHz (in lock) width 200 μ S
amplitude 3.1V

VT48 c  p.r.f. 1kHz (in lock) width 1 μ S
amplitude 2.6V

VT49 e  1 kHz square wave amplitude = 2.4V

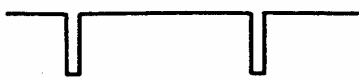
VT49 c  p.r.f. 1 kHz (in lock) width 1 μ S
amplitude = 3.7V

VT53 c or D36 k  p.r.f. 1 kHz (in lock) width 1.2 μ S
amplitude = 13V

Pin 32 Square wave 1 kHz 2V p.p.

Pin 54 (VT51 c)  1 kHz, triangular 8V p.p.

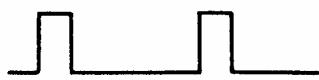
VT60 c  p.r.f. 1 kHz (in lock) width 200 μ S
amplitude = 3.4V

VT61 c  p.r.f. 1 kHz width 2 μ S amplitude 2.7V

VT62 c  p.r.f. 1 kHz (always) width 2 μ S
amplitude 2.7V

VT63 c  p.r.f. 1 kHz (in lock) up-down ratio
variable amplitude 3.4V

VT66 c  p.r.f. 1 kHz (in lock) up-down ratio
variable amplitude 3.4V inverse of
VT63 c.

VT63.c 66 c out of lock gives a blurred "changing" waveform

VT64 c (a) in lock. no signal (3.8V DC)
(b) out of lock - frequency high width 2 μ S
amplitude 3.5V, p.r.f. depends
on error frequency, but may
be very low.
(c) out of lock - frequency high, no signal (3.8V DC).

VT65 c As VT64 c except that it gives output if frequency is low, not otherwise.

VT69 c out of lock - frequency high



amplitude = 4.0V

Waveform depends on nature of error frequency.

Down for about 3 mS, up for variable period (may jitter)
in lock, or frequency low

DC. 12.8V

VT70 c as VT69c except waveform occurs with frequency low
height = 3.6V

in lock or frequency high, DC = 7.8

VT75

out of lock amplitude 3.7V 
jittery frequency, normally down for about 100 mS.
The in-lock amplitude is 3.5V DC .

pin 45

in lock . DC voltage from output of frequency comparator
(actual voltage depends on frequency setting)
normally between 1V and 9V

out of lock jittery waveform with 1 kHz triangular wave about
10.5V p.p. plus spikes. Best listened to on
headphones, (can put phones directly onto pin
45 or OL terminal on casting - no capacitor needed).

Table of Typical Waveforms

PM3 Board

VT1 c Sinusoidal 4V p.p. frequency = that of main oscillator 12.7 to 18.7 MHz but with some distortion.

Pin 3 Low level sine wave plus other (higher) frequencies superimposed. Typical level = 200 mV p.p.
frequency = 700-1699 kHz depending on frequency setting.

VT5 c  700-1699 kHz 1.4V p.p.

VT6 c  700-1699 kHz
3.7 V p.p. fall time = 30 nS

LG1 pin 6 square wave 350-850 kHz 2.8 V p.p.

LG1 pin 12  square wave 70-170 kHz 3.0V p.p.
1 up to 4 down

LG2 pin 6 square wave 35-85 kHz 3.0V p.p.

LG2 pin 12  7-17 kHz 3.0V p.p. 1 up to 4 down

LG3 pin 5 and pin 12 Waveforms dependent on 100 kHz switch setting 3.0 V p.p. Note all above waveforms on LG1, 2, 3, may have variable level "tops" to wave forms.

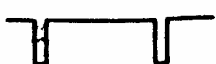
LG1, 2 or 3, pin 1 or Pin 13 or VT8 c  1 kHz p. r. f. (in lock)
300 nS width
4.2 V p.p. amplitude

VT9 c  p. r. f. 1 kHz in lock
Amplitude = 0.7 p.p.
width = 300 μ S

Pin 7  in lock p. r. f. = 1kHz
down for 200 μ S
Amplitude = 3.2V

D22 a square wave 350-850 kHz 6V p. p.

Remaining waveforms are all sinusoidal at frequency of main oscillator
12.7-18.7 MHz

VT44 c 500 mV p. p.

VT43 c 1.5V p. p.

VT42 c 1.8V p. p.

VT45 c 1.6V p. p.)
) assuming 50 Ω lead connected

Pin 98 700 mV p. p.) to output.

T8 pin 1 300 mV p. p.

T9 pin 3 300 mV p. p.

CHAPTER 6

DISMANTLING AND RE-ASSEMBLY

NOTE: The term 'Manpack' is used to denote the complete assembly of transmitter/receiver together with the Synthesizer Unit.

ACCESS TO THE SYNTHESIZER

1. (1) Remove the complete Manpack unit from its case (refer to the Manpack section of the handbook).
- (2) Place the unit with the front panel face downwards on the bench.
- (3) Remove the antenna flying lead (red plug) from its socket beside the A. T. U.
- (4) At the rear of the unit free the two metal straps (one screw from each) which hold the two chassis together. Grip the two chassis while freeing the straps to prevent the T/R chassis from falling.
- (5) Hinge the trans/receiver chassis downwards to a horizontal position.
- (6) The side covers of the synthesizer unit can now be removed for making tests and adjustments.
- (7) To re-assemble follow the above instructions in the opposite sense and sequence.

ACCESS TO THE PRINTED CIRCUIT BOARDS

2. Board PM1 (or PM2) is on the outward side of the synthesizer; board PM3 is on the inward side facing the trans/receiver unit.
 - (1) Release the screws which secure the side covers to the synthesizer and remove the cover (or covers).
 - (2) Release the screws which secure the board to be tested and hinge the board outwards to reveal the components. To avoid the risk of short circuits between the board track and frame metalwork, place a sheet of thick polythene or similar beneath the board and lower the board down on to it.

CAUTION: When re-fitting the boards, ensure that the power is off and carefully avoid trapping any leads between the board and chassis.

REMOVAL OF THE SYNTHESIZER UNIT

3. (1) Refer to paragraph 1 and carry out instructions (1) to (4).
- (2) Remove the escutcheon panel from the Synthesizer front panel (4 screws).
- (3) From each switch knob on the synthesizer ease off the plastic cap which reveals a slotted hexagon ($\frac{1}{4}$ inch AF) screw. Remove the screw from each knob.
- (4) Pull off the control knobs and unscrew the lock-nuts from each shaft.
- (5) Remove the dessicator unit which is mounted between the synthesizer panel and the meter. The dessicator can be unscrewed from the front.
- (6) Remove three screws from each of the two brackets which secure the synthesizer frame to the Manpack.
- (7) Hold the synthesizer unit in position and place the Manpack assembly in a horizontal position.
- (8) Draw the synthesizer unit away from the front panel sufficient to allow the two r.f. leads and the soldered leads to be disconnected from the synthesizer terminals.
- (9) Remove the synthesizer unit.
- (10) Replace the dessicator in the front panel.
- (11) To re-assemble, follow the above instructions in the opposite sense and sequence.

CHAPTER 7

LIST OF COMPONENTS

CONTENTS

	<u>Page.</u>
ALTERNATIVES	7 - 1a
SYNTHESIZER MAIN ASSEMBLY ITEMS	7 - 1
COMPONENTS ON PM1 AND PM2 BOARDS	7 - 2
Resistors	7 - 2
Potentiometers	7 - 7
Capacitors	7 - 7
Inductors and Transformers	7 - 11
Integrated Circuits	7 - 11
Transistors	7 - 11
Diodes	7 - 13
Crystals	7 - 15
5 MHz Oscillator Unit (PM1 Board)	7 - 15
COMPONENTS ON PM3 BOARD	
Resistors	7 - 16
Potentiometers	7 - 19
Capacitors	7 - 19
Inductors	7 - 22
Transformers	7 - 22
Integrated Circuits	7 - 23
Transistors	7 - 23
Diodes	7 - 24

NOTE: Component values are quoted as follows:

Resistors

No suffix = ohms
Suffix 'k' = ~~k~~ohms
Suffix 'M' = Megohms

Capacitors

No suffix = microfarads
Suffix 'p' = picofarads

ALTERNATIVES

It will be found in some cases that due to the requirement for standardisation, or the availability of an improved type of component, that an item shown in the components list may differ from the information shown in the circuit illustration. Generally the information in the Components List is more up-to-date. The following table gives the items which are most likely to be affected.

Alternative Component Types

<u>Components List Item</u>	<u>Alternative</u>
Diode: Type 1N4149	Type 1N4148
15 μ F Tantalum capacitor	10 μ F Tantalum Kemet K10 E10

Transistor: The type U14603/1 is shown in circuit diagrams and component lists. The recommended replacement is the Motorola 2N4126 or the Transitron (U.K.) TES014

Cat. Ref.	Value	Description	Rat	Tol %	Racal Part No.	Manufacturer
--------------	-------	-------------	-----	----------	-------------------	--------------

FOREWORD: The list of components is in three divisions.
Page 7-1 contains items not mounted on a board.
Pages 7-2 to 7-14 contain the common component list for the PM1 and PM2 boards.
Pages 7-15 to 7-24 contain the component list for the PM3 board.

SYNTHESIZER MAIN ASSEMBLY ITEMS:

Synthesizer Assembly Type MA 920 (complete) MDA.75428

Chassis Components

Capacitors

1C1	.01	Ceramic	25	-25+50	911845	Erie 831T/25
1C2	.01	Ceramic	25	-25+50	911845	Erie 831T/25
1C3	0.1	Polycarbonate	100	20	914173	S.T.C. PMA M100

Switches

SW1		MHz selection			MBSW75779	
SW2		KHz x 100 selection			MBSW75780	
SW3		KHz x 10 selection			MBSW75781	
SW4		KHz x 1 selection			MBSW75781	

Switch Knobs

	Knob for MHz switch	711059
	Knobs for KHz switches	711058

Connectors

SKT1	10.7 MHz output	906878	Belling Lee L1403/CS/AP
SKT2	Main Osc. output	906878	Belling Lee L1403/CS/AP

Cct. Ref.	Value	Description	Rat	Tol %	Racal Part No.	Manufacturer
--------------	-------	-------------	-----	----------	-------------------	--------------

PM1 and PM2 BOARDS

Printed Circuit Board Assembly Type PM1 (complete) MDA75388/B
 Printed Circuit Board Assembly Type PM2 (complete) MDA75388/A

COMPONENTS ON PM1 and PM2 BOARDS

Resistors

	ohms		watts			
R1	100k	Metal film		1	915872	Erg EEO-1-FCO
R2	178k	Metal film		1	915873	Erg EEO-1-FCO
R3	680k	Metal Oxide		2	914951	Electrosil TR5
R4	33.2k	Metal film		1	914961	Erg EEO-1-FCO
R5	115k	Metal film		1	915878	Erg EEO-1-FCO
R6	226k	Metal film		1	915880	Erg EEO-1-FCO
R7	3.32k	Metal film		1	914967	Erg EEO-1-FCO
R8	910k	Metal Oxide		2	915881	Electrosil TR5
R9	1k	Carbon	0.3	10	914943	Dubilier U.B.T.
R10	22k	Carbon	0.3	10	914949	Dubilier U.B.T.
R11	3.3k	Carbon	0.3	10	914945	Dubilier U.B.T.
R12	3.3k	Carbon	0.3	10	914945	Dubilier U.B.T.
R13	470	Carbon	0.3	10	914941	Dubilier U.B.T.
R14	1k	Carbon	0.3	10	914943	Dubilier U.B.T.
R15	3.3k	Carbon	0.3	10	914945	Dubilier U.B.T.
R16	3.3k	Carbon	0.3	10	914945	Dubilier U.B.T.
R17	470	Carbon	0.3	10	914941	Dubilier U.B.T.
R18	3.3k	Carbon	0.3	10	914945	Dubilier U.B.T.
R19	3.3k	Carbon	0.3	10	914945	Dubilier U.B.T.
R20	680	Carbon	0.3	10	914942	Dubilier U.B.T.
R21	3.3k	Carbon	0.3	10	919945	Dubilier U.B.T.
R22	470	Carbon	0.3	10	914941	Dubilier U.B.T.
R23	220	Carbon	0.3	10	914940	Dubilier U.B.T.
R24	47	Carbon	0.3	10	914937	Dubilier U.B.T.
R25	470	Carbon	0.3	10	914941	Dubilier U.B.T.
R26	22k	Carbon	0.3	10	914949	Dubilier U.B.T.
R27	22k	Carbon	0.3	10	914949	Dubilier U.B.T.
R28	6.8k	Carbon	0.3	10	914947	Dubilier U.B.T.
R29	1k	Carbon	0.3	10	914943	Dubilier U.B.T.
R30	2.2k	Carbon	0.3	10	914944	Dubilier U.B.T.
R31	4.7k	Metal oxide		5	900989	Electrosil TR4
R32	4.7k	Metal oxide		5	900989	Electrosil TR4
R33	3.3k	Carbon	0.3	10	914945	Dubilier U.B.T.
R34	1k	Carbon	0.3	10	914943	Dubilier U.B.T.
R35	47	Carbon	0.3	10	914937	Dubilier U.B.T.

Cct. Ref.	Value	Description	Rat	Tol %	Racal Part No.	Manufacturer
<u>PML/PM2 (continued)</u>						
<u>Resistors (contd)</u>			watts			
R36	1k	Carbon	0.3	10	914943	Dubilier U.B.T.
R37	47k	Carbon	0.3	10	914950	Dubilier U.B.T.
R38	100	Carbon	0.3	10	914938	Dubilier U.B.T.
R39	150	Carbon	0.3	10	914939	Dubilier U.B.T.
R40	10	Carbon	0.3	10	914936	Dubilier U.B.T.
R41	22k	Carbon	0.3	10	914949	Dubilier U.B.T.
R42	47k	Carbon	0.3	10	914950	Dubilier U.B.T.
R43	6.8k	Carbon	0.3	10	914947	Dubilier U.B.T.
R44	470	Carbon	0.3	10	914941	Dubilier U.B.T.
R45	6.8k	Carbon	0.3	10	914947	Dubilier U.B.T.
R46	4.7k	Carbon	0.3	10	914946	Dubilier U.B.T.
R47	2.2k	Carbon	0.3	10	914944	Dubilier U.B.T.
R48	100k	Metal Oxide		5	908293	Electrosil TR4
R49	15k	Metal Oxide		5	908280	Electrosil TR4
R50	NOT USED					
R51	100	Carbon	0.3	10	914938	Dubilier U.B.T.
R52	4.7k	Carbon	0.3	10	914946	Dubilier U.B.T.
R53	4.7k	Carbon	0.3	10	914946	Dubilier U.B.T.
R54	6.8k	Carbon	0.3	10	914947	Dubilier U.B.T.
R55	100	Carbon	0.3	10	914938	Dubilier U.B.T.
R56	100	Carbon	0.3	10	914938	Dubilier U.B.T.
R57	47	Carbon	0.3	10	914937	Dubilier U.B.T.
R58	150	Carbon	0.3	10	914939	Dubilier U.B.T.
R59	100	Carbon	0.3	10	914938	Dubilier U.B.T.
R60	10k	Carbon	0.3	10	914948	Dubilier U.B.T.
R61	NOT USED					
R62	NOT USED					
R63	NOT USED					
R64	NOT USED					
R65	10k	Carbon	0.3	10	914948	Dubilier U.B.T.
R66	22k	Carbon	0.3	10	914949	Dubilier U.B.T.
R67	2.2k	Carbon	0.3	10	914944	Dubilier U.B.T.
R68	47	Carbon	0.3	10	914937	Dubilier U.B.T.
R69	100	Carbon	0.3	10	914938	Dubilier U.B.T.
R70	680	Carbon	0.3	10	914942	Dubilier U.B.T.
R71	10k	Metal Oxide		5	900986	Electrosil TR4
R72	4.7k	Metal Oxide		5	900989	Electrosil TR4
R73	1k	Carbon	0.3	10	914943	Dubilier U.B.T.
R74	22k	Carbon	0.3	10	914949	Dubilier U.B.T.
R75	2.2k	Carbon	0.3	10	914944	Dubilier U.B.T.

Cct. Ref.	Value	Description	Rat	Tol %	Racal Part No.	Manufacturer
<u>PM1/PM2 (continued)</u>						
<u>Resistors (contd)</u>						
				watt		
R76	47k	Carbon	0.3	10	914950	Dubilier U.B.T.
R77	1k	Carbon	0.3	10	914943	Dubilier U.B.T.
R78	47	Carbon	0.3	10	914937	Dubilier U.B.T.
R79	12.4k	Metal film		1	914963	Erg EEO-1-FC2
R80	2.2k	Carbon	0.3	10	914944	Dubilier U.B.T.
R81	1k	Carbon	0.3	10	914943	Dubilier U.B.T.
R82	13k	Metal film		1	914738	Erg EEO-1-FC2
R83	4.7k	Carbon	0.3	10	914946	Dubilier U.B.T.
R84	2.2k	Carbon	0.3	10	914944	Dubilier U.B.T.
R85	47	Carbon	0.3	10	914937	Dubilier U.B.T.
R86	11k	Metal film		1	914962	Erg EEO-1-FC2
R87	4.7k	Carbon	0.3	10	914946	Dubilier U.B.T.
R88	2.2k	Carbon	0.3	10	914944	Dubilier U.B.T.
R89	47	Carbon	0.3	10	914937	Dubilier U.B.T.
R90	13k	Metal film		1	914738	Erg EEO-1-FC2
R91	4.7k	Carbon	0.3	10	914946	Dubilier U.B.T.
R92	2.2k	Carbon	0.3	10	914944	Dubilier U.B.T.
R93	47	Carbon	0.3	10	914937	Dubilier U.B.T.
R94	47	Carbon	0.3	10	914937	Dubilier U.B.T.
R95	14.3k	Metal film		1	914964	Erg EEO-1-FC2
R96	4.7k	Carbon	0.3	10	914946	Dubilier U.B.T.
R97	47	Carbon	0.3	10	914937	Dubilier U.B.T.
R98	1k	Carbon	0.3	10	914943	Dubilier U.B.T.
R99	NOT USED					
R100	2.2k	Carbon	0.3	10	914944	Dubilier U.B.T.
R101	47	Carbon	0.3	10	914937	Dubilier U.B.T.
R102	3.3k	Carbon	0.3	10	914945	Dubilier U.B.T.
R103	3.3k	Carbon	0.3	10	914945	Dubilier U.B.T.
R104	470	Carbon	0.3	10	914941	Dubilier U.B.T.
R105	470	Carbon	0.3	10	914941	Dubilier U.B.T.
R106	6.8k	Carbon	0.3	10	914947	Dubilier U.B.T.
R107	6.8k	Carbon	0.3	10	914947	Dubilier U.B.T.
R108	2.2k	Carbon	0.3	10	914944	Dubilier U.B.T.
R109	2.2k	Carbon	0.3	10	914944	Dubilier U.B.T.
R110	470	Carbon	0.3	10	914941	Dubilier U.B.T.
R111	680	Carbon	0.3	10	914942	Dubilier U.B.T.
R112	220	Carbon	0.3	10	914940	Dubilier U.B.T.
R113	47	Carbon	0.3	10	914937	Dubilier U.B.T.
R114	1k	Carbon	0.3	10	914943	Dubilier U.B.T.
R115	47k	Carbon	0.3	10	914950	Dubilier U.B.T.

Cct. Ref.	Value	Description	Rat	Tol %	Racal Part No.	Manufacturer
<u>PML/PM2 (continued)</u>						
<u>Resistors (contd)</u>			watts			
R116	150	Carbon	0.3	10	914939	Dubilier U.B.T.
R117	10k	Carbon	0.3	10	914948	Dubilier U.B.T.
R118	22k	Carbon	0.3	10	914949	Dubilier U.B.T.
R119	1k	Carbon	0.3	10	914943	Dubilier U.B.T.
R120	1k	Carbon	0.3	10	914943	Dubilier U.B.T.
R121	4.7k	Carbon	0.3	10	914946	Dubilier U.B.T.
R122	NOT USED					
R123	NOT USED					
R124	NOT USED					
R125	NOT USED					
R126	NOT USED					
R127	NOT USED					
R128	NOT USED					
R129	NOT USED					
R130	1k	Carbon	0.3	10	914943	Dubilier U.B.T.
R131	100	Carbon	0.3	10	914938	Dubilier U.B.T.
R132	NOT USED					
R133	15k	Metal Oxide		5	908280	Electrosil TR4
R134	2.2k	Carbon	0.3	10	914944	Dubilier U.B.T.
R135	4.7k	Carbon	0.3	10	914946	Dubilier U.B.T.
R136	4.7k	Carbon	0.3	10	914946	Dubilier U.B.T.
R137	2.2k	Carbon	0.3	10	914944	Dubilier U.B.T.
R138	5.6k	Metal Oxide		5	908273	Electrosil TR4
R139	33k	Metal Oxide		5	908291	Electrosil TR4
R140	27k	Metal Oxide		5	908295	Electrosil TR4
R141	22k	Metal Oxide		5	908273	Electrosil TR4
R142	5.6k	Metal Oxide		5	908273	Electrosil TR4
R143	330	Carbon	0.3	10	915107	Dubilier U.B.T.
R144	47	Carbon	0.3	10	914937	Dubilier U.B.T.
R145	330	Carbon	0.3	10	915107	Dubilier U.B.T.
R146	5.6k	Metal Oxide		5	908273	Electrosil TR4
R147	33k	Metal Oxide		5	908291	Electrosil TR4
R148	3.3k	Carbon	0.3	10	914945	Dubilier U.B.T.
R149	22k	Carbon	0.3	10	914949	Dubilier U.B.T.
R150	1k	Carbon	0.3	10	914943	Dubilier U.B.T.
R151	1k	Carbon	0.3	10	914943	Dubilier U.B.T.
R152	47k	Carbon	0.3	10	914950	Dubilier U.B.T.
R153	100	Carbon	0.3	10	914938	Dubilier U.B.T.
R154	100k	Metal Oxide		5	908293	Electrosil TR4
R155	Selected by test					

Cct. Ref.	Value	Description	Rat	Tol %	Racal Part No.	Manufacturer
--------------	-------	-------------	-----	----------	-------------------	--------------

PM1/PM2 (continued)

Resistors (contd)

watts

R156	15k	Metal Oxide		5	908280	Electrosil TR4
R157	1k	Metal Oxide		5	908267	Electrosil TR4
R158	22k	Carbon	0.3	10	914949	Dubilier U.B.T.
R159	6.8k	Carbon	0.3	10	914947	Dubilier U.B.T.
R160	150	Carbon	0.3	10	914939	Dubilier U.B.T.
R161	7.15k	Metal film		1	914952	Erg EEO-1-FCO
R162	NOT USED					
R163	22k	Carbon	0.1	10	902524	Erie 15
R164	NOT USED					
R165	47k	Carbon	0.3	10	914950	Dubilier U.B.T.
R166	1k	Carbon	0.3	10	914943	Dubilier U.B.T.
R167	100	Carbon	0.3	10	914938	Dubilier U.B.T.
R168	NOT USED					
R169	4.7k	Carbon	0.3	10	914946	Dubilier U.B.T.
R170	22k	Carbon	0.3	10	914949	Dubilier U.B.T.
R171	2.2k	Carbon	0.3	10	914944	Dubilier U.B.T.
R172	22k	Carbon	0.3	10	914949	Dubilier U.B.T.
R173	2.2k	Carbon	0.3	10	914944	Dubilier U.B.T.
R174	22k	Carbon	0.3	10	914949	Dubilier U.B.T.
R175	100	Carbon	0.3	10	914938	Dubilier U.B.T.
R176	1k	Carbon	0.3	10	914943	Dubilier U.B.T.
R177	47k	Carbon	0.3	10	914950	Dubilier U.B.T.
R178	47k	Carbon	0.3	10	914950	Dubilier U.B.T.
R179	4.7k	Carbon	0.3	10	914946	Dubilier U.B.T.
R180	1k	Carbon	0.3	10	914943	Dubilier U.B.T.
R181	2.2k	Carbon	0.3	10	914944	Dubilier U.B.T.
R182	2.2k	Carbon	0.3	10	914944	Dubilier U.B.T.
R183	22k	Carbon	0.3	10	914949	Dubilier U.B.T.
R184	22k	Carbon	0.3	10	914949	Dubilier U.B.T.
R185	100	Carbon	0.3	10	914938	Dubilier U.B.T.
R186	2.2k	Carbon	0.3	10	914944	Dubilier U.B.T.
R187	2.2k	Carbon	0.3	10	914944	Dubilier U.B.T.
R188	4.7k	Carbon	0.3	10	914946	Dubilier U.B.T.
R189	150	Carbon	0.3	10	914939	Dubilier U.B.T.
R190	47k	Carbon	0.3	10	914950	Dubilier U.B.T.
R191	47k	Carbon	0.3	10	914950	Dubilier U.B.T.
R192	4.7k	Carbon	0.3	10	914946	Dubilier U.B.T.
R193	4.7k	Carbon	0.3	10	914946	Dubilier U.B.T.
R194	22k	Carbon	0.3	10	914949	Dubilier U.B.T.
R195	4.7k	Carbon	0.3	10	914946	Dubilier U.B.T.

Cct. Ref.	Value	Description	Rat	Tol %	Racal Part No.	Manufacturer
--------------	-------	-------------	-----	----------	-------------------	--------------

PM1/PM2 (continued)

Resistors (contd)

watts

R196	4.7k	Carbon	0.3	10	914946	Dubilier U.B.T.
R197	4.7k	Carbon	0.3	10	914946	Dubilier U.B.T.
R198	4.7k	Carbon	0.3	10	914946	Dubilier U.B.T.
R199	150	Carbon	0.3	10	914939	Dubilier U.B.T.
R200	220	Carbon	0.3	10	914940	Dubilier U.B.T.
R201	4.7k	Carbon	0.3	10	914946	Dubilier U.B.T.
R202	4.7k	Carbon	0.3	10	914946	Dubilier U.B.T.
R203	3.9k	Carbon		5	900990	Electrosil TR4
R204	3.9k	Carbon		5	900990	Electrosil TR4
R205	10k	Carbon	0.3	10	914948	Dubilier U.B.T.
R206	10k	Carbon	0.3	10	914948	Dubilier U.B.T.
R207	2.2k	Carbon	0.3	10	914944	Dubilier U.B.T.
R208	1k	Carbon	0.3	10	914943	Dubilier U.B.T.
R209	10k	Carbon	0.3	10	914948	Dubilier U.B.T.
R210	4.7k	Carbon	0.3	10	914946	Dubilier U.B.T.
R211	4.7k	Carbon	0.3	10	914946	Dubilier U.B.T.
R212	10k	Carbon	0.3	10	914948	Dubilier U.B.T.
R213	6.8k	Carbon	0.3	10	914947	Dubilier U.B.T.
R214	22k	Carbon	0.3	10	914949	Dubilier U.B.T.
R215	470	Carbon	0.3	10	914941	Dubilier U.B.T.
R216	100	Carbon	0.3	10	914938	Dubilier U.B.T.

Potentiometer

RV1 2.2k

Egen 522 (preferred)
or Morganite 62H

Capacitors

C1	0.1	Polycarbonate	100	20	914173	S.T.C. PMA M100
C2	33p	Ceramic		10	914909	Erie 831/N750
C3	22p	Ceramic		10	914931	Erie 831/N750
C4	33p	Ceramic		10	914909	Erie 831/N750
C5	4.7	Tantalum	20	20	914914	U.C. Kemet 4R7E20

Cct. Ref.	Value	Description	Rat	Tol %	Racal Part No.	Manufacturer
<u>PML/PM2 (continued)</u>						
<u>Capacitors (contd)</u>						
C6	.01	Ceramic	25	-25+50	911845	Erie 831T/25
C7	.01	Ceramic	25	-25+50	911845	Erie 831T/25
C8	220p	Ceramic		10	914916	Erie 831 /N4200
C9	100p	Ceramic		10	911904	Erie 831 /N3300
C10	.01	Ceramic	25	-25+50	911845	Erie 831T/25
C11	4.7	Tantalum	20	20	914914	U.C. Kemet 4R7E20
C12	.01	Ceramic	25	-25+50	911845	Erie 831T/25
C13	.01	Ceramic	25	-25+30	911845	Erie 831T/25
C14	4.7	Tantalum	20	20	914914	U.C. Kemet 4R7E20
C15	NOT USED					
C16	.01	Ceramic	25	-25+50	911845	Erie 831T/25
C17	220p	Ceramic		10	914916	Erie 831/N4200
C18	4.7	Tantalum	20	20	914914	U.C. Kemet 4R7E20
C19	.01	Ceramic	25	-25+50	911845	Erie 831T/25
C20	.01	Ceramic	25	-25+50	911845	Erie 831T/25
C21	.01	Ceramic	25	-25+50	911845	Erie 831T/25
C22	.01	Ceramic	25	-25+50	911845	Erie 831T/25
C23	4.7	Tantalum	20	20	914914	U.C. Kemet 4R7E20
C24	220p	Ceramic		10	914916	Erie 831 /N4200
C25	.01	Ceramic	25	-25+50	911845	Erie 831T/25
C26	4.7	Tantalum	20	20	914914	U.C. Kemet 4R7E20
C27	.01	Ceramic	25	-25+50	911845	Erie 831T/25
C28	.01	Ceramic	25	-25+50	911845	Erie 831T/25
C29	.01	Ceramic	25	-25+50	911845	Erie 831T/25
C30	.01	Ceramic	25	-25+50	911845	Erie 831T/25
C31	.01	Ceramic	25	-25+50	911845	Erie 831T/25
C32	.01	Ceramic	25	-25+50	911845	Erie 831T/25
C33	.01	Ceramic	25	-25+50	911845	Erie 831T/25
C34	NOT USED					
C35	NOT USED					
C36	.01	Ceramic	25	-25+50	911845	Erie 831T/25
C37	15	Tantalum	10	20	915188	U.C. Kemet K15E10
C38	.01	Ceramic	25	-25+50	911845	Erie 831T/25
C39	15	Tantalum	10	20	915188	U.C. Kemet K15E10
C40	.01	Ceramic	25	-25+50	911845	Erie 831T/25
C41	.01	Ceramic	25	-25+50	911845	Erie 831T/25
C42	12p	Trimmer			914905	Erie Type 565-013
C43 *		(Selected on test		$\frac{1}{2}$ pF		Erie Style 831 NPO
C44 *		(see NOTE		10	914931	Erie Style 831 N750
C45	.01	Ceramic	25	-25+50	911845	Erie 831T/25

NOTE:- The values of C43 and C44 are selected by factory test.
Nominal values are C43, 4.7p and C44, 22p.

Cct. Ref.	Value	Description	Rat volts	Tol %	Racal Part No.	Manufacturer
<u>PM1/PM2 (continued)</u>						
<u>Capacitors (contd)</u>						
C46	470p	Silver Mica	50	5	915187	J & M C5E
C47	100p	Silver Mica	50	5	915186	J & M C5E
C48	.01	Ceramic	25	-25+50	911845	Erie 831T/25
C49	.01	Ceramic	25	-25+50	911845	Erie 831T/25
C50	.01	Ceramic	25	-25+50	911845	Erie 831T/25
C51	220p	Ceramic		10	914916	Erie 831/N4200
C52	.01	Ceramic	25	-25+50	911845	Erie 831T/25
C53	.01	Ceramic	25	-25+50	911845	Erie 831T/25
C54	10p	Ceramic		10	914912	Erie 831/NPO
C55	15	Tantalum	10	20	915188	U.C. Kemet K15E10
C56	.01	Ceramic	25	-25+50	911845	Erie 831T/25
C57	100p	Silver Mica	50	2	915183	J & M C5E
C58	10p	Ceramic		10	914912	Erie 831/NPO
C59	470p	Silver Mica	50	2	915184	J & M C5E
C60	15	Tantalum	10	20	915188	U.C. Kemet K15E10
C61	10p	Ceramic		10	914912	Erie 831/NPO
C62	.01	Ceramic	25	-25+50	911845	Erie 831T/25
C63	.0022	Silver Mica		2	915185	J & M C12E
C64	15	Tantalum	10	20	915188	U.C. Kemet K15E10
C65	.01	Ceramic	25	-25+50	911845	Erie 831T/25
C66	10p	Ceramic		10	914912	Erie 831 NPO
C67	.01	Polycarbonate		2	914933	S.T.C. PMA.G100
C68	NOT USED					
C69	33	Tantalum	10	20	901100	U.C. Kemet K33J10S
C70	.01	Ceramic	25	-25+50	911845	Erie 831T/25
C71	15	Tantalum	10	20	915188	U.C. Kemet K15E10
C72	33p	Ceramic		10	914909	Erie 831/N750
C73	.047	Polycarbonate		2	914934	S.T.C. PMA G100
C74	.01	Ceramic	25	-25+50	911845	Erie 831T/25
C75	4.7	Tantalum	20	20	914914	U.C. Kemet K4R7E20
C76	15	Tantalum	10	20	915188	U.C. Kemet K15E10
C77	.01	Ceramic	25	-25+50	911845	Erie 831T/25
C78	.01	Ceramic	25	-25+50	911845	Erie 831T/25
C79	NOT USED					
C80	15	Tantalum	10	20	915188	U.C. Kemet K15E10
C81	.01	Ceramic	25	-25+50	911845	Erie 831T/25
C82	.01	Ceramic	25	-25+50	911845	Erie 831T/25
C83	100p	Silver Mica	50	2	915183	J & M C5E
C84	.01	Ceramic	25	-25+50	911845	Erie 831T/25
C85	.01	Ceramic	25	-25+50	911845	Erie 831T/25

Cct. Ref.	Value	Description	Rat	Tol %	Racal Part No.	Manufacturer
<u>PM1/PM2 (continued)</u>			volts			
<u>Capacitors (contd)</u>						
C86	15	Tantalum	10	20	915188	U.C. Kemet K15E10
C87	100p	Ceramic		10	911904	Erie 831/N3300
C88	220p	Ceramic		10	914916	Erie 831/N4200
C89	100p	Ceramic		10	911904	Erie 831/N3300
C90	.01	Ceramic	25	-25+50	911845	Erie 831T/25
C91	33p	Ceramic		10	914909	Erie 831/N750
C92	.01	Ceramic	25	-25+50	911845	Erie 831T/25
C93	22p	Ceramic		10	914931	Erie 831/N750
C94	NOT USED					
C95	NOT USED					
C96	100p	Ceramic		10	911904	Erie 831/N3300
C97	15	Tantalum	10	20	915188	U.C. Kemet K15E10
C98	15	Tantalum	10	20	915188	U.C. Kemet K15E10
C99	4.7	Tantalum	20	20	914914	U.C. Kemet K15E10
C100	0.1	Polycarbonate		20	914173	S.T.C. PMA M100
C101	.01	Polycarbonate		5	914913	S.T.C. PMA J100
C102	0.1	Polycarbonate		20	914173	S.T.C. PMA M100
C103	15	Tantalum	10	20	915188	U.C. Kemet K15E10
C104	15	Tantalum	10	20	915188	U.C. Kemet K15E10
C105	15	Tantalum	10	20	915188	U.C. Kemet K15E10
C106	4.7	Tantalum	20	20	914914	U.C. Kemet KR7E20
C107	33p	Ceramic		10	914909	Erie 831/N750
C108	4.7	Tantalum	20	20	914914	U.C. Kemet K4R7E20
C109	.01	Polycarbonate		5	914913	S.T.C. PMA J100
C110	4.7	Tantalum	20	20	914914	U.C. Kemet K4R7E20
C111	NOT USED					
C112	4.7	Tantalum	20	20	914914	U.C. Kemet K4R7E20
C113	NOT USED					
C114	15	Tantalum	10	20	915188	U.C. Kemet K15E10
C115	100p	Ceramic		10	911904	Erie 831/N3300
C116	100p	Ceramic		10	911904	Erie 831/N3300
C117	15	Tantalum	10	20	915188	U.C. Kemet K15E10
C118	33p	Ceramic		10	914909	Erie 831/N750
C119	33p	Ceramic		10	914909	Erie 831/N750
C120	15	Tantalum	10	20	915188	U.C. Kemet K15E10
C121	15	Tantalum	10	20	915188	U.C. Kemet K15E10
C122	15	Tantalum	10	20	915188	U.C. Kemet K15E10
C123	220p	Ceramic		10	914916	Erie 831/N4200
C124	220p	Ceramic		10	914916	Erie 831/N4200
C125	22p	Ceramic		10	914931	Erie 831/N750

Cct. Ref.	Value	Description	Rat volts	Tol %	Racal Part No.	Manufacturer
<u>PM1/PM2 (continued)</u>						
<u>Capacitors (contd)</u>						
C126	22p	Ceramic		10	914931	Erie 831/N750
C127	0.1	Polycarbonate		20	914173	S.T.C. PMA M100
C128	0.1	Polycarbonate		20	914173	S.T.C. PMA M100
C129	100p	Ceramic		10	911904	Erie 831/N3300
C130	4.7	Tantalum	20	20	914914	U.C. Kemet K4R7E20
C131	4.7	Tantalum	20	20	914914	U.C. Kemet K4R7E20
C132	100	Ceramic		10	911904	Erie 831/N3300
C133	4.7	Tantalum	20	20	914914	U.C. Kemet K4R7E20
C134	4.7	Tantalum	20	20	914914	U.C. Kemet K4R7E20
C135	15	Tantalum	10	20	915188	U.C. Kemet K15E10
C136	.01	Ceramic	25	-25+50	911845	Erie 831T/25
C137	.01	Ceramic	25	-25+50	911845	Erie 831T/25
C138	4.7	Tantalum	20	20	914914	U.C. Kemet K4R7E20
C139	15	Tantalum	10	20	915188	U.C. Kemet K15E10
C140	0.1	Ceramic	12	20	21-1552	Centralab DA482

Inductors and Transformers

L1	68 μ	Choke			915848	Delavan 1537-68
L2	68 μ	Choke			915848	Delavan 1537-68
L3	68 μ	Choke			915848	Delavan 1537-68
L4 and L5	NOT USED					
L6	68 μ	Choke			915848	Delavan 1537-68
T1		Transformer			MBT.75382	
T2		Transformer			MCT.75381	

Integrated Circuits

IG1		Dual in-line clocked flip-flop			914935	Motorola MC822P
-----	--	--------------------------------	--	--	--------	-----------------

Transistors

VT1					912678	Motorola 2N4126
VT2					915232	Fairchild U14603/1
VT3					906842	S.T.C. 2N2369
VT4					915232	Fairchild U14603/1
VT5					906842	S.T.C. 2N2369

Cct.	Ref.	Value	Description	Rat	Tol %	Racal Part No.	Manufacturer
<u>PML/PM2 (continued)</u>							
<u>Transistors (contd)</u>							
	VT6					914900	Mullard BC109
	VT7					914908	Mullard BSX82
	VT8					906842	S.T.C. 2N2369
	VT9					906842	S.T.C. 2N2369
	VT10					914900	Mullard BC109
	VT11					906842	S.T.C. 2N2369
	VT12					915232	Fairchild U14603/1
	VT13					915232	Fairchild U14603/1
	VT14					915232	Fairchild U14603/1
	VT15					906842	S.T.C. 2N2369
	VT16					906842	S.T.C. 2N2369
	VT17	NOT USED					
	VT18					906842	S.T.C. 2N2369
	VT19					906842	S.T.C. 2N2369
	VT20					906842	S.T.C. 2N2369
	VT21					906842	S.T.C. 2N2369
	VT22					906842	S.T.C. 2N2369
	VT23					906842	S.T.C. 2N2369
	VT24					906842	S.T.C. 2N2369
	VT25					906842	S.T.C. 2N2369
	VT26					906842	S.T.C. 2N2369
	VT27					906842	S.T.C. 2N2369
	VT28					906842	S.T.C. 2N2369
	VT29					906842	S.T.C. 2N2369
	VT30					906842	S.T.C. 2N2369
	VT31					906842	S.T.C. 2N2369
	VT32					906842	S.T.C. 2N2369
	VT33					906842	S.T.C. 2N2369
	VT34					906842	S.T.C. 2N2369
	VT35					906842	S.T.C. 2N2369
	VT36					906842	S.T.C. 2N2369
	VT37					906842	S.T.C. 2N2369
	VT38	NOT USED					
	VT39	NOT USED					
	VT40					906842	S.T.C. 2N2369
	VT41					906842	S.T.C. 2N2369
	VT42					906842	S.T.C. 2N2369
	VT43					914900	Mullard BC109
	VT44					914900	Mullard BC109
	VT45					906842	S.T.C. 2N2369

Cct. Ref.	Value	Description	Rat	Tol %	Racal Part No.	Manufacturer
<u>PML/PM2 (continued)</u>						
<u>Transistors (contd)</u>						
VT46					915232	Fairchild U14603/1
VT47	NOT USED					
VT48					906842	S.T.C. 2N2369
VT49					906842	S.T.C. 2N2369
VT50					915232	Fairchild U14603/1
VT51					914900	Mullard BC109
VT52					914900	Mullard BC109
VT53					915232	Fairchild U14603/1
VT54					914907	U.C. 2N4392
VT55					914908	Mullard BSX82
VT56					914900	Mullard BC109
VT57					914900	Mullard BC109
VT58					915232	Fairchild U14603/1
VT59	NOT USED					
VT60					906842	S.T.C. 2N2369
VT61					906842	S.T.C. 2N2369
VT62					906842	S.T.C. 2N2369
VT63					906842	S.T.C. 2N2369
VT64					906842	S.T.C. 2N2369
VT65					906842	S.T.C. 2N2369
VT66					906842	S.T.C. 2N2369
VT67					906842	S.T.C. 2N2369
VT68					906842	S.T.C. 2N2369
VT69					906842	S.T.C. 2N2369
VT70					906842	S.T.C. 2N2369
VT71					915232	Fairchild U14603/1
VT72					914900	Mullard BC109
VT73					906842	S.T.C. 2N2369
VT74					906842	S.T.C. 2N2369
VT75					906842	S.T.C. 2N2369
VT76					914900	Mullard BC109
VT77					914900	Mullard BC109
<u>Diodes</u>						
D1		Silicon			914898	S.T.C. 1N4149
D2		Silicon			914898	S.T.C. 1N4149
D3		Silicon			914898	S.T.C. 1N4149
D4		Silicon			914898	S.T.C. 1N4149
D5		Silicon			914898	S.T.C. 1N4149

Cct. Ref.	Value	Description	Rat	Tol %	Racal Part No.	Manufacturer
<u>PML/PM2 (continued)</u>						
<u>Diodes (contd)</u>						
D6		Silicon			914898	S.T.C. 1N4149
D7		Silicon			914898	S.T.C. 1N4149
D8		Silicon			914898	S.T.C. 1N4149
D9		Silicon			914898	S.T.C. 1N4149
D10		Silicon			914898	S.T.C. 1N4149
D11		Silicon			914898	S.T.C. 1N4149
D12		Silicon			914898	S.T.C. 1N4149
D13		Silicon			914898	S.T.C. 1N4149
D14		Silicon			914898	S.T.C. 1N4149
D15		Voltage Var.Capacitance				Motorola MV1638
D16		Voltage Var.Capacitance				Motorola MV1638
D17		Silicon			914898	S.T.C. 1N4149
D18		Silicon			914898	S.T.C. 1N4149
D19	NOT USED					
D20		Silicon			914898	S.T.C. 1N4149
D21		Silicon			914898	S.T.C. 1N4149
D22		Silicon			914898	S.T.C. 1N4149
D23		Silicon			914898	S.T.C. 1N4149
D24		Silicon			914898	S.T.C. 1N4149
D25		Silicon			914898	S.T.C. 1N4149
D26		Silicon			914898	S.T.C. 1N4149
D27		Silicon			914898	S.T.C. 1N4149
D28		Silicon			914898	S.T.C. 1N4149
D29		Silicon			914898	S.T.C. 1N4149
D30		Silicon			914898	S.T.C. 1N4149
D31		Silicon			914898	S.T.C. 1N4149
D32		Silicon			914898	S.T.C. 1N4149
D33		Silicon			914898	S.T.C. 1N4149
D34	NOT USED					
D35	NOT USED					
D36		Silicon			914898	S.T.C. 1N4149
D37		Silicon			914898	S.T.C. 1N4149
D38	NOT USED					
D39	NOT USED					
D40		Silicon			914898	S.T.C. 1N4149
D41		Silicon			914898	S.T.C. 1N4149
D42		Silicon			914898	S.T.C. 1N4149
D43		Silicon			914898	S.T.C. 1N4149
D44		Silicon			914898	S.T.C. 1N4149
D45		Silicon			914898	S.T.C. 1N4149

Cct. Ref.	Value	Description	Rat	Tol %	Racal Part No.	Manufacturer
--------------	-------	-------------	-----	----------	-------------------	--------------

PM1/PM2 (continued)

Diodes (contd)

D46		Silicon			914898	S.T.C. 1N4149
D47		Silicon			914898	S.T.C. 1N4149
D48		Silicon			914898	S.T.C. 1N4149

Crystals

XL1	12 MHz				MCD 75400/A	
XL2	13 MHz				MCD 75400/B	
XL3	14 MHz				MCD 75400/C	
XL4	15 MHz				MCD 75400/D	
XL5	16 MHz				MCD 75400/E	
XL6	17 MHz				MCD 75400/F	
XL7	5 MHz (PM2 Board only)				MCD 75402	
XL8	10.6993 MHz				MCD 75401	
XL9	10.6993 MHz				MCD 75401	

Frequency Reference Oscillator Unit (PM1 Board only)

TCXO	5 MHz Oscillator Unit				MBD 75426	
------	-----------------------	--	--	--	-----------	--

Cct. Ref.	Value	Description	Rat	Tol %	Racal Part No.	Manufacturer
--------------	-------	-------------	-----	----------	-------------------	--------------

PM3 BOARD

Printed Circuit Board Assembly Type PM3 MDA75359
(complete)

COMPONENTS ON PM3 BOARD

Resistors

	<u>ohms</u>		<u>watts</u>			
R1	3.3k	Carbon	0.3	10	914945	Dubilier U.B.T.
R2	3.3k	Carbon	0.3	10	914945	Dubilier U.B.T.
R3	100	Carbon	0.3	10	914938	Dubilier U.B.T.
R4	47	Carbon	0.3	10	914937	Dubilier U.B.T.
R5	150	Carbon	0.3	10	914939	Dubilier U.B.T.
R6	NOT USED					
R7	NOT USED					
R8	NOT USED					
R9	NOT USED					
R10	22k	Carbon	0.3	10	914949	Dubilier U.B.T.
R11	2.2k	Carbon	0.3	10	914944	Dubilier U.B.T.
R12	10k	Carbon	0.3	10	914948	Dubilier U.B.T.
R13	10k	Carbon	0.3	10	914948	Dubilier U.B.T.
R14	2.2k	Carbon	0.3	10	914944	Dubilier U.B.T.
R15	220	Carbon	0.3	10	914940	Dubilier U.B.T.
R16	10	Carbon	0.3	10	914936	Dubilier U.B.T.
R17	10	Carbon	0.3	10	914936	Dubilier U.B.T.
R18	10	Carbon	0.3	10	914936	Dubilier U.B.T.
R19	2.2k	Carbon	0.3	10	914944	Dubilier U.B.T.
R20	100	Carbon	0.3	10	914938	Dubilier U.B.T.
R21	NOT USED					
R22	10k	Carbon	0.3	10	914948	Dubilier U.B.T.
R23	1k	Carbon	0.3	10	914943	Dubilier U.B.T.
R24	4.7k	Carbon	0.3	10	914946	Dubilier U.B.T.
R25	22k	Metal Oxide		5	908269	Electrosil TR4
R26	2.2k	Carbon	0.3	10	914944	Dubilier U.B.T.
R27	22k	Carbon	0.3	10	914949	Dubilier U.B.T.
R28	2.2k	Carbon	0.3	10	914944	Dubilier U.B.T.
R29	33k	Metal Oxide		5	908291	Electrosil TR4
R30	4.7k	Carbon	0.3	10	914946	Dubilier U.B.T.
R31	100	Carbon	0.3	10	914938	Dubilier U.B.T.
R32	10k	Carbon	0.3	10	914948	Dubilier U.B.T.
R33	22k	Carbon	0.3	10	914949	Dubilier U.B.T.
R34	1k	Carbon	0.3	10	914943	Dubilier U.B.T.
R35	NOT USED					

Cct. Ref.	Value	Description	Rat	Tol %	Racal Part No.	Manufacturer
--------------	-------	-------------	-----	----------	-------------------	--------------

PM3 (continued)

Resistors (contd)

	<u>ohms</u>		<u>watts</u>			
R36	NOT USED					
R37	NOT USED					
R38	NOT USED					
R39	NOT USED					
R40	22.1k	Metal film		1	914956	Erg EEO-1-FCO
R41	16.5k	Metal film		1	914954	Erg EEO-1-FCO
R42	17.4k	Metal film		1	914955	Erg EEO-1-FCO
R43	4.7k	Carbon	0.3	10	914946	Dubilier U.B.T.
R44	4.7k	Carbon	0.3	10	914946	Dubilier U.B.T.
R45	4.7k	Carbon	0.3	10	914946	Dubilier U.B.T.
R46	4.7k	Carbon	0.3	10	914946	Dubilier U.B.T.
R47	100	Carbon	0.3	10	914938	Dubilier U.B.T.
R48	47	Carbon	0.3	10	914937	Dubilier U.B.T.
R49	220	Composition	0.1	10	See Note	Erie 15
R50	7.15k	Metal film		1	914966	Erg EEO-1-FCO

NOTE: The value of R49 is selected by test. Normal value is 220Ω.

R51	7.87k	Metal film		1	914953	Erg EEO-1-FCO
R52	6.8k	Carbon	0.3	10	914947	Dubilier U.B.T.
R53	2.2k	Carbon	0.3	10	914944	Dubilier U.B.T.
R54	2.2k	Carbon	0.3	10	914944	Dubilier U.B.T.
R55	6.8k	Carbon	0.3	10	914947	Dubilier U.B.T.
R56	150	Wirewound	2.5	10	915248	Welwyn WW W21
R57	1k	Carbon	0.3	10	914943	Dubilier U.B.T.
R58	6.8k	Carbon	0.3	10	914947	Dubilier U.B.T.
R59	NOT USED					
R60	NOT USED					
R61	NOT USED					
R62	NOT USED					
R63	NOT USED					
R64	NOT USED					
R65	100	Carbon	0.3	10	914938	Dubilier U.B.T.
R66	22k	Metal Oxide		5	908260	Electrosil TR4
R67	4.7k	Carbon	0.3	10	914946	Dubilier U.B.T.
R68	3.3k	Carbon	0.3	10	914945	Dubilier U.B.T.
R69	1k	Carbon	0.3	10	914943	Dubilier U.B.T.
R70	4.7k	Carbon	0.3	10	914946	Dubilier U.B.T.

NOTE: R66 is selected on test. The nominal value is 22k.

Cct. Ref.	Value	Description	Rat	Tol %	Racal Part No.	Manufacturer
--------------	-------	-------------	-----	----------	-------------------	--------------

PM3 (continued)

Resistors (Contd)

	<u>ohms</u>		<u>watts</u>			
R71	NOT USED					
R72	10k	Metal Oxide		5	900986	Electrosil TR4
R73	NOT USED					
R74	10k	Metal Oxide		5	900986	Electrosil TR4
R75	10k	Metal Oxide		5	900986	Electrosil TR4
R76	680	Metal Oxide		5	908390	Electrosil TR4
R77	NOT USED					
R78	2.2k	Carbon	0.3	10	914944	Dubilier U.B.T.
R79	NOT USED					
R80	2.2k	Carbon	0.3	10	914944	Dubilier U.B.T.
R81	1k	Carbon	0.3	10	914943	Dubilier U.B.T.
R82	4.7k	Carbon	0.3	10	914946	Dubilier U.B.T.
R83	220	Carbon	0.3	10	914940	Dubilier U.B.T.
R84	22k	Metal Oxide	0.25	5		Electrosil TR4.
R85	22k	Metal Oxide	0.25	5		Electrosil TR4.
R86	4.7k	Carbon	0.3	10	914946	Dubilier U.B.T.
R87	220	Carbon	0.3	10	914940	Dubilier U.B.T.
R88	47k	Carbon	0.3	10	914950	Dubilier U.B.T.
R89	1k	Carbon	0.3	10	914943	Dubilier U.B.T.
R90	NOT USED					
R91	1k	Carbon	0.3	10	914943	Dubilier U.B.T.
R92	680	Carbon	0.3	10	914942	Dubilier U.B.T.
R93	680	Carbon	0.3	10	914942	Dubilier U.B.T.
R94	47	Carbon	0.3	10	914937	Dubilier U.B.T.
R95	470	Carbon	0.3	10	914941	Dubilier U.B.T.
R96	4.7k	Carbon	0.3	10	914946	Dubilier U.B.T.
R97	2.2k	Carbon	0.3	10	914944	Dubilier U.B.T.
R98	6.8k	Carbon	0.3	10	914947	Dubilier U.B.T.
R99	150	Carbon	0.3	10	914939	Dubilier U.B.T.
R100	2.2k	Carbon	0.3	10	914944	Dubilier U.B.T.
R101	220	Carbon	0.3	10	914940	Dubilier U.B.T.
R102	150	Carbon	0.3	10	914939	Dubilier U.B.T.
R103	47	Carbon	0.3	10	914937	Dubilier U.B.T.
R104	100	Carbon	0.3	10	914938	Dubilier U.B.T.
R105	47	Carbon	0.3	10	914937	Dubilier U.B.T.

Cct. Ref.	Value	Description	Rat	Tol %	Racal Part No.	Manufacturer
--------------	-------	-------------	-----	----------	-------------------	--------------

PM3(continued)

Resistors (contd)

	<u>ohms</u>		<u>watts</u>			
R106	1k	Carbon	0.3	10	914943	Dubilier U.B T.
R107	2.2k	Carbon	0.3	10	914944	Dubilier U.B.T.
R108	1k	Carbon	0.3	10	914943	Dubilier U.B T.

Potentiometers

RV1	2.2k				915674	Egen 522
RV2	2.2k				915674	Egen 522
RV3	2.2k				915674	Egen 522
RV4	NOT USED					
RV5	2.2k				915674	Egen 522
RV6	2.2k				915674	Egen 522

NOTE:-

The Morganite Type 62H may be fitted as an alternative if the Egen Type 522 is not available.

Capacitors

			<u>Volts</u>			
C1	.01	Ceramic	25	-25+50	911845	Erie 831T/25
C2	.01	Ceramic	25	-25+50	911845	Erie 831T/25
C3	.01	Ceramic	25	-25+50	911845	Erie 831T/25
C4	100p	Ceramic		10	911904	Erie 831/N3300
C5	100p	Ceramic		10	911904	Erie 831/N3300

Cct. Ref.	Value	Description	Rat	Tol %	Racal Part No.	Manufacturer
<u>PM3 (continued)</u>						
<u>Capacitors (contd)</u>						
				<u>volts</u>		
C6	NOT USED					
C7	NOT USED					
C8	NOT USED					
C9	NOT USED					
C10	.01	Ceramic	25	-25+50	911845	Erie 831T/25
C11	220p	Ceramic		10	914916	Erie 831/N4200
C12	.01	Ceramic	25	-25+50	911845	Erie 831T/25
C13	4.7	Tantalum	20	20	914914	U.C. Kemet K4R7E20
C14	.01	Ceramic	25	-25+50	911845	Erie 831T/25
C15	.01	Ceramic	25	-25+50	911845	Erie 831T/25
C16	15	Tantalum	10	20	915188	U.C. Kemet K15E10
C17	4.7	Tantalum	20	20	914914	U.C. Kemet K15E10
C18	.01	Ceramic	25	-25+50	911845	Erie 831T/25
C19	15	Tantalum	10	20	915188	U.C. Kemet K15E10
C20	.01	Ceramic	25	-25+50	911845	Erie 831T/25
C21	15	Tantalum	10	20	915188	U.C. Kemet K15E10
C22	.01	Ceramic	25	-25+50	911845	Erie 831T/25
C23	33	Tantalum	10	20	901100	U.C. Kemet K33J10S
C24	15	Tantalum	10	20	915188	U.C. Kemet K15E10
C25	100p	Ceramic		10	911904	Erie 831N330
C26	.01	Ceramic			911845	Erie 831T/25
C27	33p	Ceramic		10	914909	Erie 831N750
C28	33p	Ceramic		10	914909	Erie 831N750
C29	10p	Ceramic		10	914912	Erie 831NPO
C30	.01	Polycarbonate		5	914913	S.T.C. PMA J100
C31	.01	Ceramic	25	-25+50	911845	Erie 831T/25
C32	4.7	Tantalum	20	20	914914	U.C. Kemet K4R7E20
C33	4.7	Tantalum	20	20	914914	U.C. Kemet K4R7E20
C34	4.7	Tantalum	20	20	914914	U.C. Kemet K4R7E20
C35	15	Tantalum	10	20	915188	U.C. Kemet K15E10
C36	NOT USED					
C37	NOT USED					
C38	NOT USED					
C39	NOT USED					
C40	15	Tantalum	10	20	915188	U.C. Kemet K15E10
C41	15	Tantalum	10	20	915188	U.C. Kemet K15E10
C42	15	Tantalum	10	20	915188	U.C. Kemet K15E10
C43	4.7	Tantalum	20	20	914914	U.C. Kemet K4R7E20
C44	.01	Ceramic	25	-25+50	911845	Erie 831T/25
C45	4.7	Tantalum	20	20	914914	U.C. Kemet K4R7E20

Cct. Ref.	Value	Description	Rat	Tol %	Racal Part No.	Manufacturer
<u>PM3 (continued)</u>						
<u>Capacitors (contd)</u>			volts			
C46	4.7	Tantalum	20	20	914914	U.C. Kemet K4R7E20
C47	.01	Ceramic	25	-25+50	911845	Erie 831T/25
C48	6.8	Tantalum	35	20	910129	U.C. Kemet K6R8J35S
C49	0.1	Polycarbonate	100	±20	914173	S.T.C.PMA M100
C50	NOT USED					
C51 to C55 NOT USED						
C56	NOT USED					
C57	NOT USED					
C58	NOT USED					
C59	1.0	Tantalum	35	20	913509	U.C. Kemet K1J35KS
C60	4.7	Tantalum	20	20	914914	U.C. Kemet K4R7E20
C61	.01	Ceramic	25	-25+50	911845	Erie 831T/25
C62	4.7	Tantalum	20	20	914914	U.C. Kemet K4R7E20
C63	NOT USED					
C64	.01	Ceramic	25	-25+50	911845	Erie 831T/25
C65	22	Tantalum	15	10	907481	U.C. Kemet K22J15KS
C66	15	Tantalum	10	20	915188	U C. Kemet K15E10
C67	.01	Ceramic	25	-25+50	911845	Erie 831T/25
C68	15	Tantalum	10	20	915188	U.C. Kemet K15E10
C69	.01	Ceramic	25	-25+50	911845	Erie 831T/25
C70	.01	Ceramic	25	-25+50	911845	Erie 831T/25
C71	4.7	Tantalum	20	20	914914	U.C. Kemet K4R7E20
C72	.01	Ceramic	25	-25+50	911845	Erie 831T/25
C73	.01	Ceramic	25	-25+50	911845	Erie 831T/25
C74	100p	Ceramic		10	911904	Erie 831/N3300
C75	15	Tantalum	10	20	915188	U.C. Kemet K15E10
C76	.01	Ceramic	25	-25+50	911845	Erie 831T/25
C77	0.1	Tantalum	35	20	915443	U.C. Kemet K1R1E35
C78	.01	Ceramic	25	-25+50	911845	Erie 831T/25
C79	10p	Ceramic		10	914912	Erie 831/NP0
C80	10p	Ceramic		10	914912	Erie 831/NP0
C81	.01	Ceramic	25	-25+50	911845	Erie 831T/25
C82	.01	Ceramic	25	-25+50	911845	Erie 831T/25
C83	4.7	Tantalum	20	20	914914	U.C. Kemet K4R7E20
C84	.01	Ceramic	25	-25+50	911845	Erie 831T/25
C85	33p	Ceramic		10	914909	Erie 831/N750
C86	.01	Ceramic	25	-25+50	911845	Erie 831T/25
C87	.01	Ceramic	25	-25+50	911845	Erie 831T/25
C88	NOT USED					
C89	NOT USED					
C90	NOT USED					

Cct. Ref.	Value	Description	Rat	Tol %	Racal Part No.	Manufacturer
--------------	-------	-------------	-----	----------	-------------------	--------------

PM3 (continued)

Capacitors (contd)

volts

C91	.01	Ceramic	25	-25+50	911845	Erie 831T/25
C92	NOT USED					
C93	.01	Ceramic	25	-25+50	911845	Erie 831T/25
C94	.01	Ceramic	25	-25+50	911845	Erie 831T/25

Inductors and Transformers

	μ H					
L1	1.0	Choke			915849	Delavan 1537-12
L2	NOT USED					
L3	NOT USED					
L4	68	Choke			915848	Delavan 1537-68
L5	NOT USED					
L6	NOT USED					
L7	NOT USED					
L8	NOT USED					
L9	NOT USED					
L10	15	Choke			915850	Delavan 1537-40
L11 to L15		NOT USED				
L16	NOT USED					
L17	68	Choke			915848	Delavan 1537-68
L18	68	Choke			915848	Delavan 1537-68

Transformers

F1		Wideband transformer			MBT75382	
T2		Wideband transformer			MBT75382	
T3		Wideband transformer			MBT75382	
T4	NOT USED					
T5		Wideband transformer			MBT75385/2	
T6		Wideband transformer			MBT75382	
T7		Wideband transformer			MBT75382	
T8		Coil assembly			MCT75782	
T9		Coil assembly			MCT75783	

Qty. Ref.	Value	Description	Rat	Tol %	Racal Part No.	Manufacturer
--------------	-------	-------------	-----	----------	-------------------	--------------

PM5 (continued)

Integrated Circuits

IG1		Dual in-line decade counter			914917	Signetics N8280A
IG2		Dual in-line decade counter			914917	Signetics N8280A
IG3		Dual in-line binary counter			914918	Signetics N8281A

Transistor

VT1		Silicon n.p.n.			906842	S.T.C. 2N2369
VT2		Silicon n.p.n.			906842	S.T.C. 2N2369
VT3	NOT USED					
VT4	NOT USED					
VT5		Silicon n.p.n.			906842	S.T.C. 2N2369
VT6		Silicon n.p.n.			906842	S.T.C. 2N2369
VT7	NOT USED					
VT8		Silicon n.p.n.			906842	S.T.C. 2N2369
VT9		Silicon n.p.n.			906842	S.T.C. 2N2369
VT10		Silicon n.p.n.			906842	S.T.C. 2N2369
VT11		Silicon n.p.n.			906842	S.T.C. 2N2369
VT12		Silicon n.p.n.			906842	S.T.C. 2N2369
VT13		Silicon n.p.n.			906842	S.T.C. 2N2369
VT14		Silicon n.p.n.			906842	S.T.C. 2N2369
VT15	NOT USED					
VT16-VT19	NOT USED					
VT20		Silicon n.p.n.			914900	Mullard BC109
VT21		Silicon n.p.n.			914900	Mullard BC109
VT22		Silicon n.p.n.			914900	Mullard BC109
VT23		Silicon n.p.n.			914900	Mullard BC109
VT24		Silicon n.p.n.			915232	Fairchild U14603/1
VT25		Silicon p.n.p.			915232	Fairchild U14603/1
VT26		Silicon n.p.n.			914900	Mullard BC109
VT27		Silicon p.n.p.			915267	Mullard BFX29
VT28		Silicon n.p.n.			914900	Mullard BC109
VT29	NOT USED					
VT30	NOT USED					

Cct. Ref.	Value	Description	Rat	Tol %	Racal Part No.	Manufacturer
<u>PM3 (continued)</u>						
<u>Transistors (contd)</u>						
VT31-VT34	NOT USED					
VT35		Silicon p.n.p.			915232	Fairchild U14603/1
VT36		Silicon p.n.p.			915232	Fairchild U14603/1
VT37		Silicon n.p.n.			914900	Mullard BC109
VT38	NOT USED					
VT39		Silicon p.n.p.			915232	Fairchild U14603/1
VT40		Silicon p.n.p.			915232	Fairchild U14603/1
VT41		Silicon p.n.p.			915232	Fairchild U14603/1
VT42		Silicon n.p.n.			906842	S.T.C. 2N2369
VT43		Silicon n.p.n.			906842	S.T.C. 2N2369
VT44		Silicon n.p.n.			906842	S.T.C. 2N2369
VT45		Silicon n.p.n.			906842	S.T.C. 2N2369
VT46		Silicon n.p.n.			906842	S.T.C. 2N2369
<u>Diodes</u>						
D1		Silicon			914898	S.T.C. 1N4149
D2		Silicon			914898	S.T.C. 1N4149
D3		Silicon			914898	S.T.C. 1N4149
D4		Silicon			914898	S.T.C. 1N4149
D5	NOT USED					
D6	NOT USED					
D7	NOT USED					
D8		Silicon			914898	S.T.C. 1N4149
D9		Silicon			914898	S.T.C. 1N4149
D10		Silicon			914898	S.T.C. 1N4149
D11		Silicon			914898	S.T.C. 1N4149
D12		Silicon			914898	S.T.C. 1N4149
D13		Silicon			914898	S.T.C. 1N4149
D14		Silicon			914898	S.T.C. 1N4149
D15		Silicon			914898	S.T.C. 1N4149
D16		Silicon			914898	S.T.C. 1N4149
D17		Silicon			914898	S.T.C. 1N4149
D18	NOT USED					
D19	NOT USED					
D20		Silicon			914898	S.T.C. 1N4149
D21		Silicon			914898	S.T.C. 1N4149
D22		Silicon			914898	S.T.C. 1N4149
D23		Silicon			914898	S.T.C. 1N4149
D24		Silicon			914898	S.T.C. 1N4149
D25	NOT USED					

Cct. Ref.	Value	Description	Rat	Tol %	Racal Part No.	Manufacturer
<u>PM3 (continued)</u>						
<u>Diodes (contd)</u>						
D26-D29 NOT USED						
D30		Zener: 5.6V			912747	Mullard BZY88-C5V6
D31		Zener: 5.6V			912747	Mullard BZY88-C5V6
D32		Zener: 5.6V			912747	Mullard BZY88-C5V6
D33		Silicon			914898	S.T.C. 1N4149
D34		Silicon			914898	S.T.C. 1N4149
D35		Zener: 6.2V			911682	Mullard BZY88-C6V2
D36		Silicon			914898	S.T.C. 1N4149
D37		Zener: 6.8V			914064	Mullard BZY88-C6V8
D38		Zener: 9.1V			914899	Mullard BZY88-C9V1
D39					911460	Texas 1N4002
D40		NOT USED				
D41-D44 NOT USED						
D45		Silicon			914898	S.T.C. 1N4149
D46		Silicon			914898	S.T.C. 1N4149
D47		Silicon			914898	S.T.C. 1N4149
D48		Voltage-Var.Capacitance: ±10%				Motorola MV1650
D49		Voltage-Var.Capacitance: ±10%				Motorola MV1650
D50		Voltage-Var.Capacitance: ±10%				Motorola MV1650
D51		Voltage-Var.Capacitance: ±10%				Motorola MV1650
D52		Silicon			914898	S.T.C. 1N4149
D53		Silicon			914898	S.T.C. 1N4149
D54		Silicon			914898	S.T.C. 1N4149
D55		Silicon			914898	S.T.C. 1N4149
D56		Silicon			914898	S.T.C. 1N4149
D57		Silicon			914898	S.T.C. 1N4149
D58		Silicon			914898	S.T.C. 1N4149

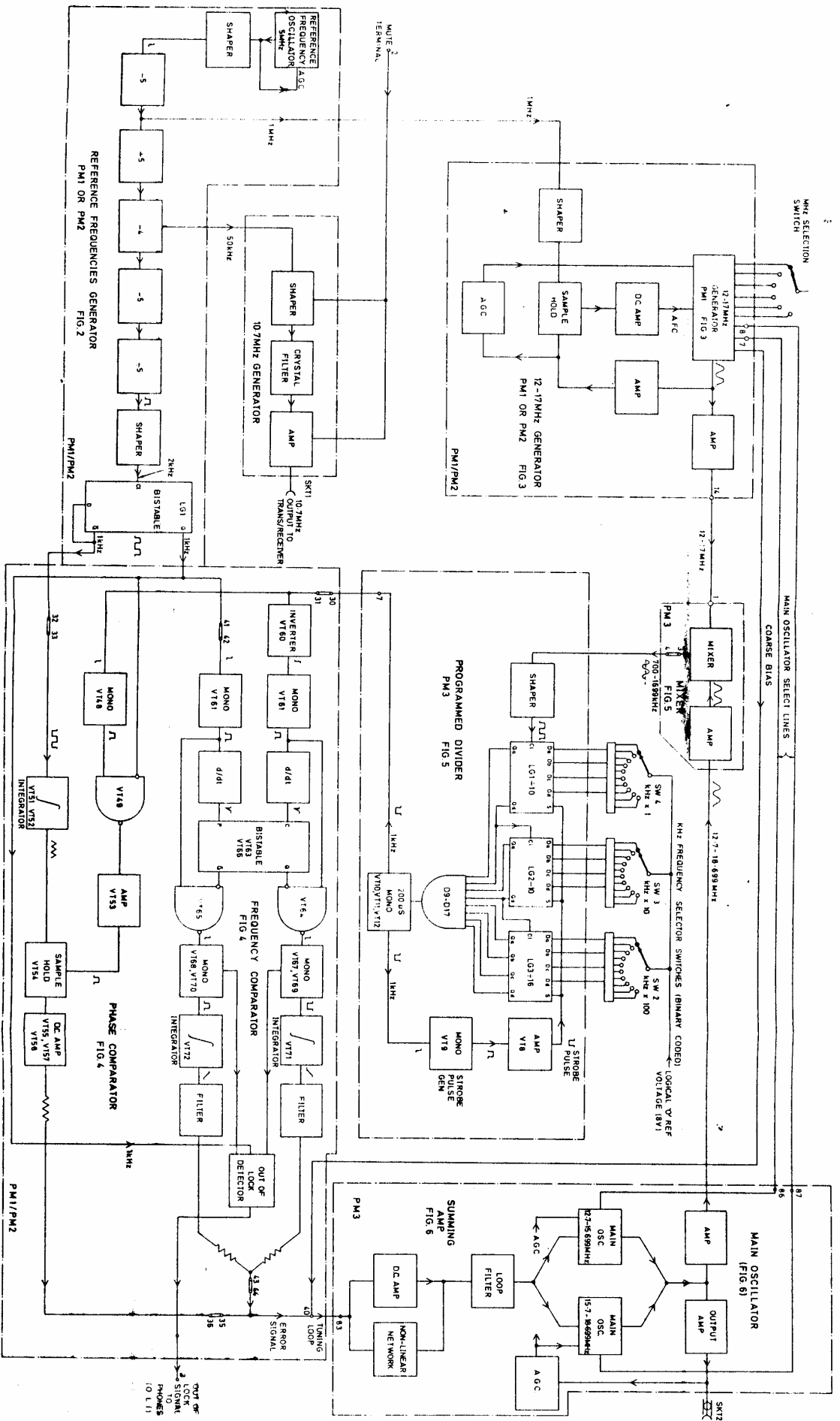

Block Diagram : Synthesizer Type MA.920

Fig 1

H31V/1
A B I

REC 11/21/13/14
1 2

Circuit: Reference Frequencies Generator and 10.7 MHz Generator
(PMI OR PMZ BOARD)

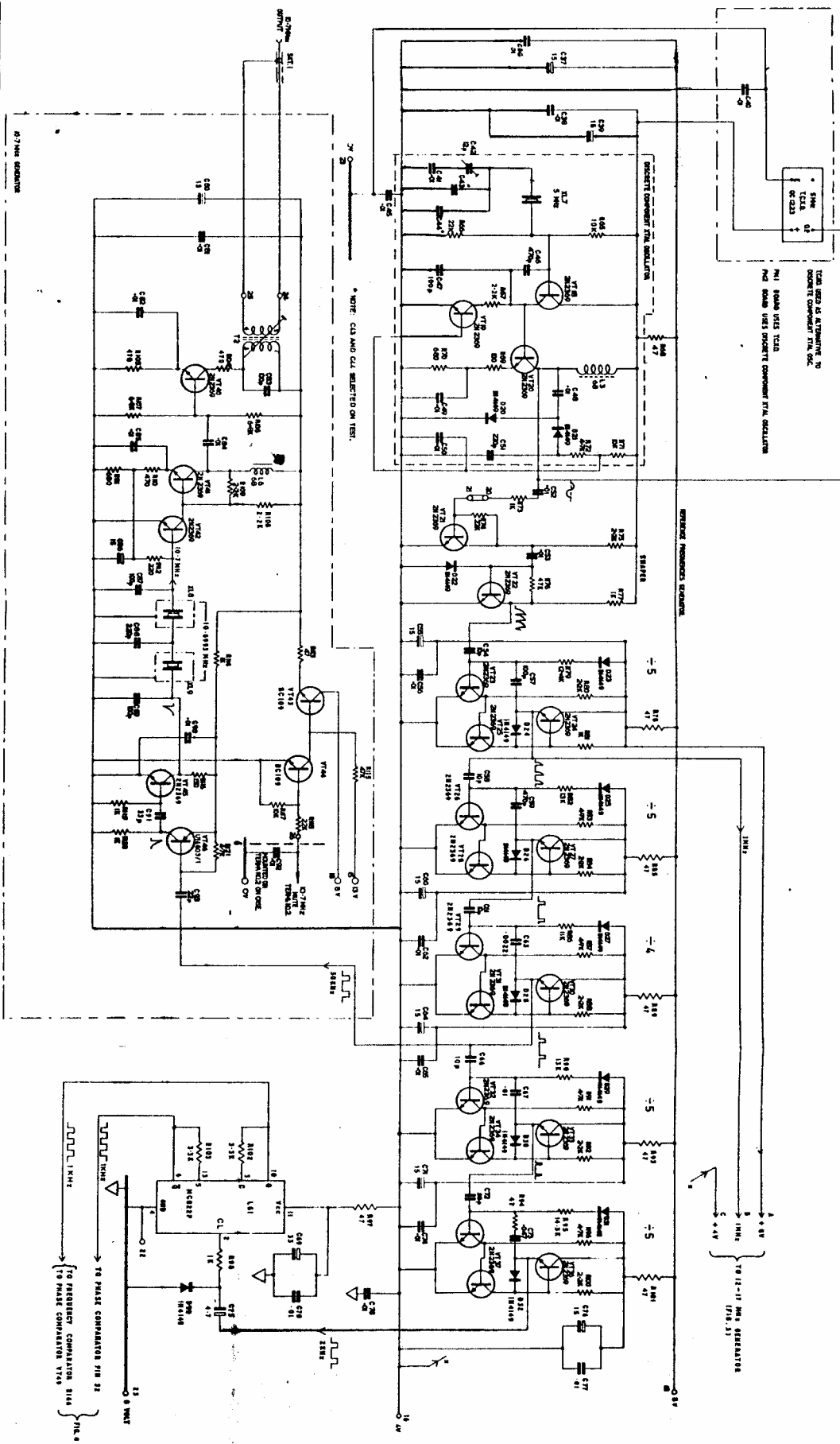
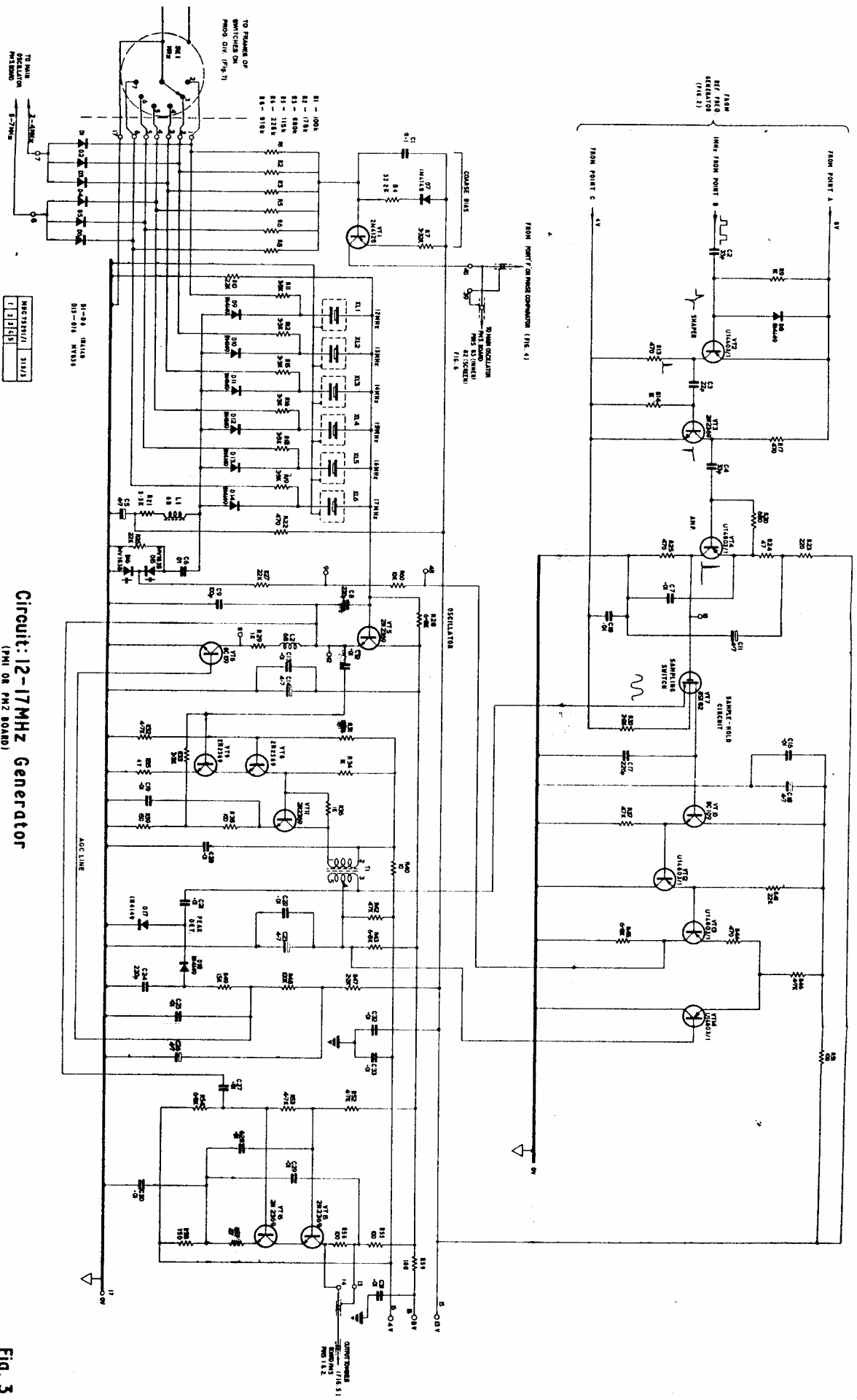
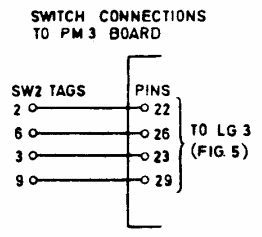
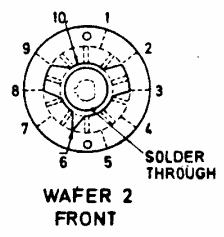
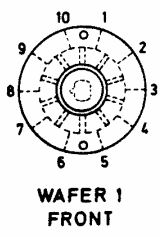
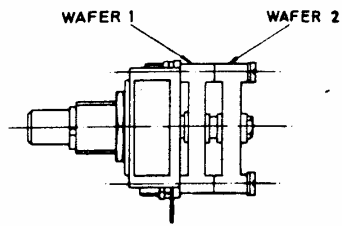
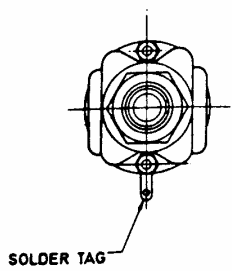

Fig. 2



Circuit: 12-17MHz Generator
(PHI OR PHZ BOARD)

Fig. 3



SW 2
KHz x 100

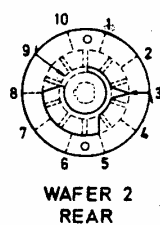
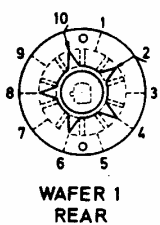

- NOTES -
- 1 WAFERS ARE SHOWN AS VIEWED FROM THE KNOB END OF CONTROL SHAFT.
 - 2 TAGS NUMBERED 10 ARE WIRED TOGETHER.

KHz x 100 SWITCH

MBSW 75780
21

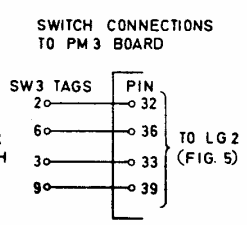
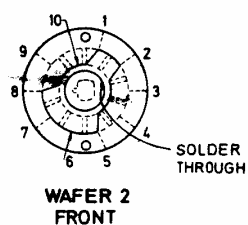
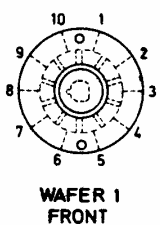

SW 3
KHz x 10

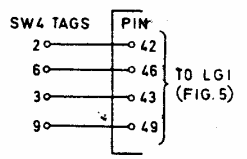
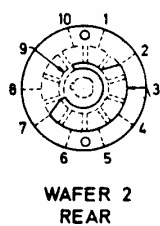
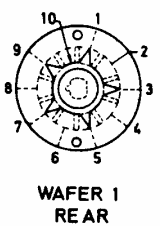

SW 4
KHz x 1

KHzx10 AND KHz x 1 SWITCHES

MBSW 75781/315/7
21

Binary Coded KHz Switches

Fig 7

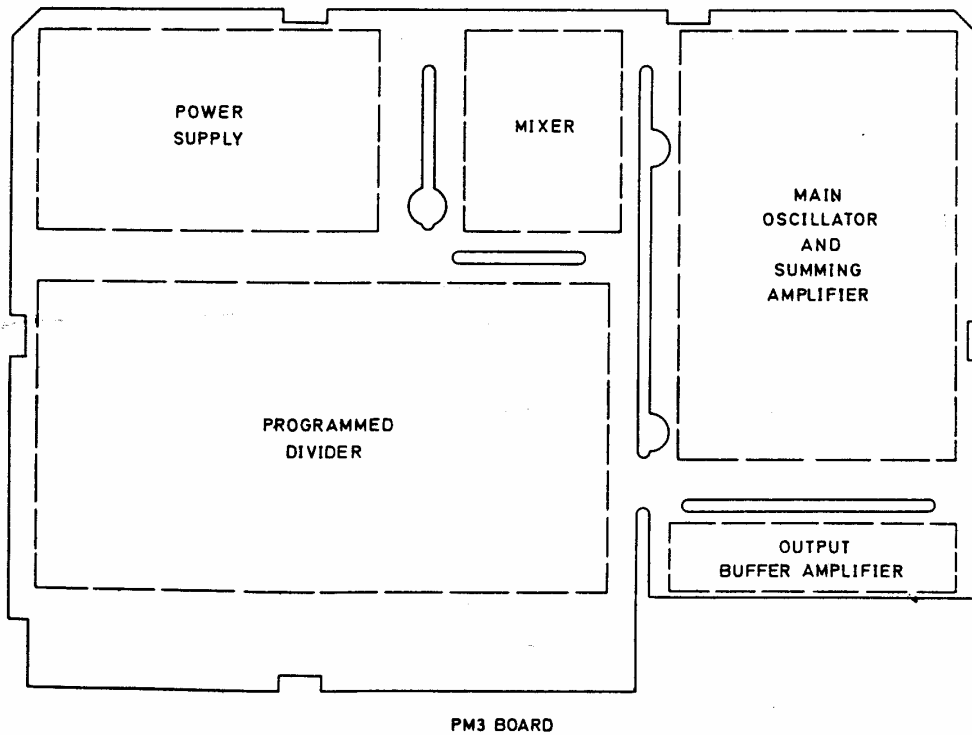
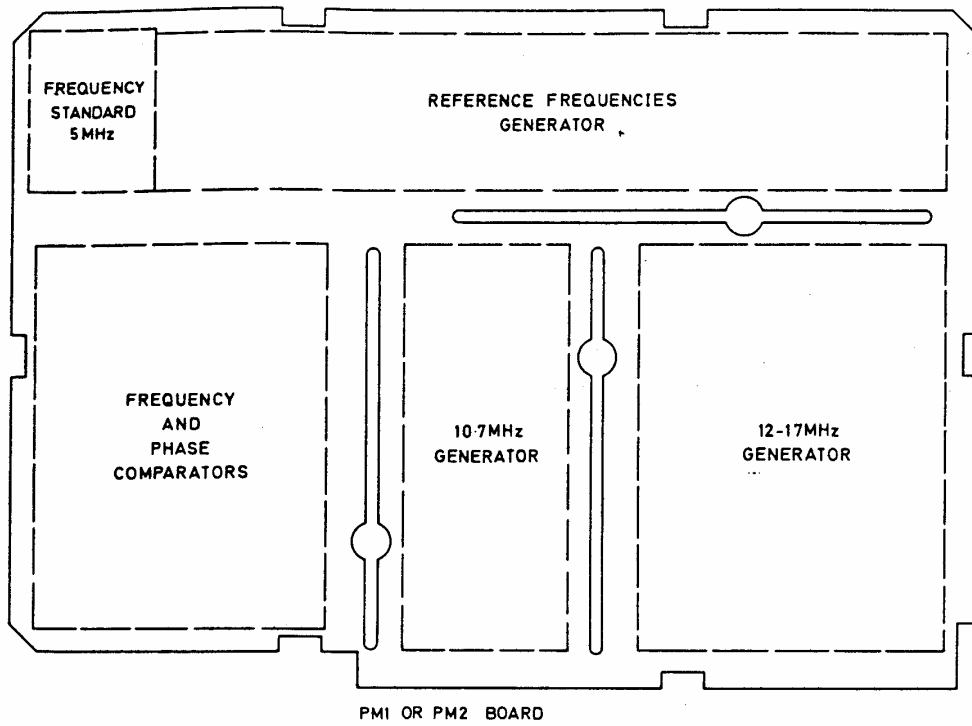

HN1374

Key Diagram of Board Layouts

Fig. 8

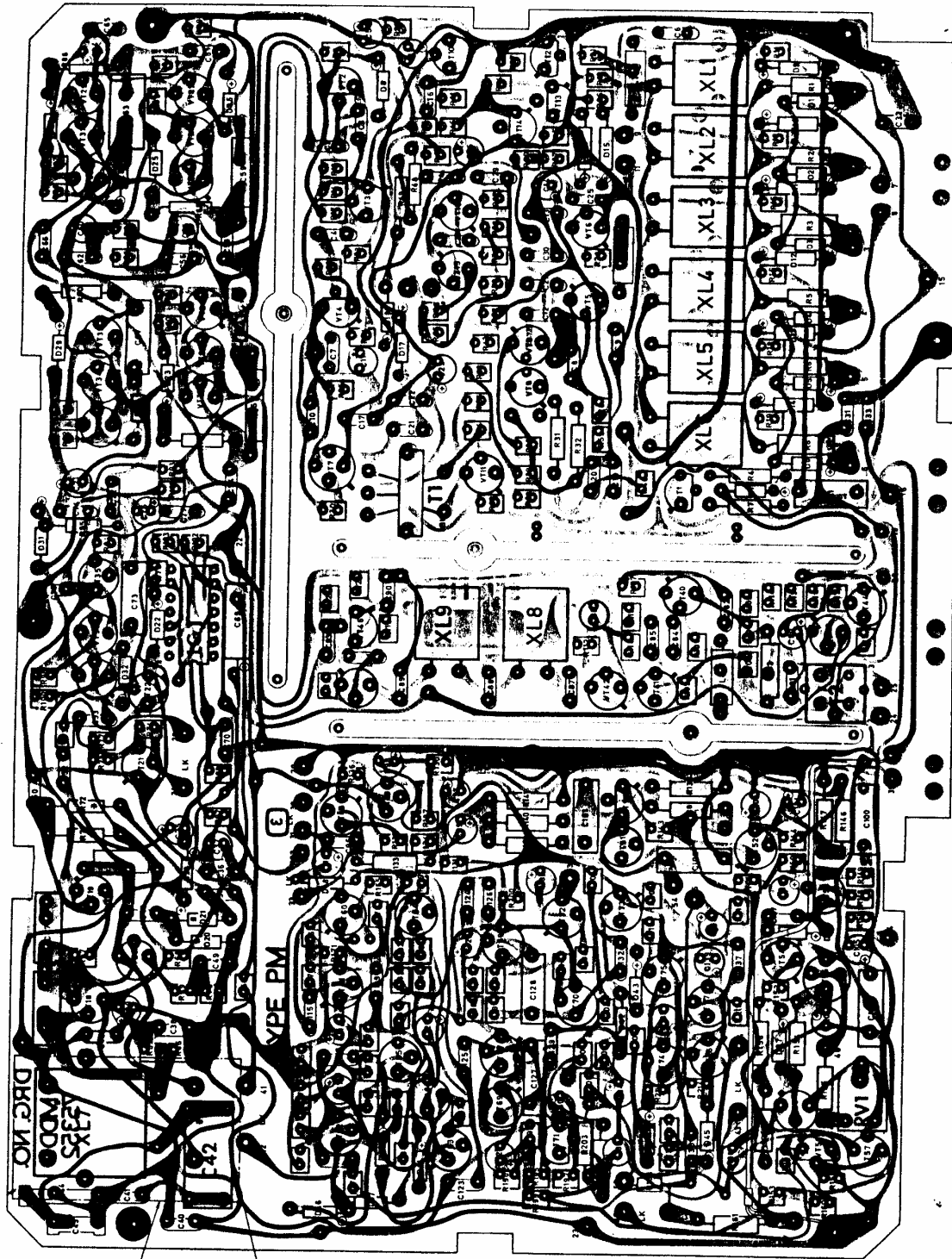

SEALED CRYSTAL OSCILLATOR
FITTED TO PM1 BOARD ONLY

ALL COMPONENTS MARKED
THUS - B ARE NOT FITTED
TO PM1 BOARD.

0157A 02-71-0157A

Component Layout : PM1 or PM2 Board

Fig. 9

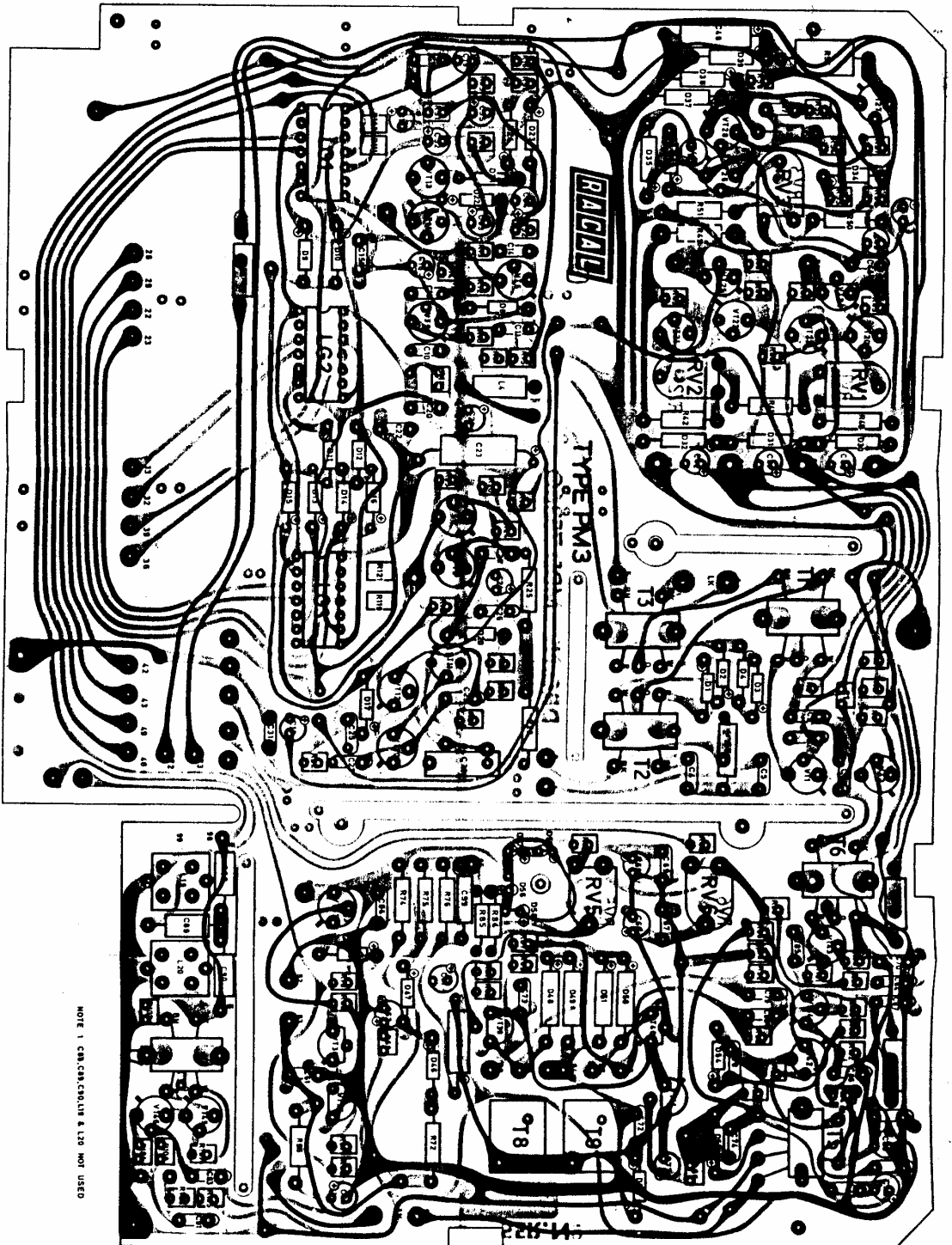

Component Layout : PM3 Board

Fig. 10