



ROHDE & SCHWARZ

Communications Division

Repair Manual

1 - kW HF TRANSCEIVER

XK 859C1

680.1210

VOLUME 2

Manual consists of 4 volumes

Repair Manual

**1 - kW HF TRANSCEIVER
XK 859C1**

consisting of:

Volumes 1 and 2

RECEIVER / EXCITER GX 859C1

Volume 3

1 - kW HF POWER AMPLIFIER VK 859C1

and

RACK, STATIONARY KG 859C4

Volume 4

POWER SUPPLY IN 859C1

and

POWER SUPPLY IN 859C2



ROHDE & SCHWARZ

Communications Division

Repair Manual

RECEIVER / EXCITER

GX 859C1

680.2017

VOLUME 2

Manual consists of 2 volumes

733.0764.62.03 - 3

Repair Manual
RECEIVER / EXCITER
GX 859C1

consisting of:

Volume 1

1. **MAINFRAME KR 852P1**
2. **POWER SUPPLY IN 852P2**
3. **PROCESSOR GS 852H2**
4. **Tx/Rx SECTION GX 852P1**
5. **SYNTHESIZER GF 852P1**
6. **MODEM GM 852P1**

Volume 2

1. **DIGITALLY - TUNED FILTER FK 852P2**
2. **MOTOR - TUNED FILTER FK 852P4**
3. **LOW - PASS FILTER FK 852P5**
4. **CONTROL UNIT GB 853C1**
5. **FSK MODEM GM 852P2**
6. **EMC FILTER FK852P7**

Repair Manual

1 - kW HF TRANSCEIVER XK 859C1

consisting of:

Volumes 1 and 2

RECEIVER / EXCITER GX 859C1

Volume 3

1 - kW HF POWER AMPLIFIER VK 859C1

and

RACK, STATIONARY KG 859C4

Volume 4

POWER SUPPLY IN 859C1

and

POWER SUPPLY IN 859C2



ROHDE & SCHWARZ

Communications Division

Repair Manual

DIGITALLY TUNED FILTER

FK 852P2

647.0019

DIGITALLY TUNED FILTER
FK 852P2

Repair Manual
Part 0: List of Contents

- 0.1 -

LIST OF CONTENTS

	Page
1. Characteristics (see User Manual) .	1.1
<hr/>	
2. Preparation for Use and Operation (see User Manual) .	2.1
<hr/>	
3. Maintenance (see User Manual) .	3.1
<hr/>	
4. Troubleshooting (see User Manual) .	4.1
<hr/>	
5. Description of Function	5.1
<hr/>	
5.1 Received-signal Path ($0.4 < f < 1.5$ MHz)	5.1
5.2 Received-signal Path ($f = 1.5$ to 30 MHz)	5.1
5.3 Received-signal Path for Very Large RF Signals (> 5 V)	5.1
5.4 Received-signal Path for Frequencies < 400 kHz	5.2
5.5 RF Gain Control	5.2
5.6 Transmitted-signal Path	5.2
5.7 Data Input	5.2
5.8 Test Mode	5.2
<hr/>	
6. Repair	6.1
<hr/>	
6.1 Preliminary Remarks	6.1
6.1.1 Troubleshooting Instructions	6.1
6.1.2 Restoring the Nominal Characteristics	6.1
6.1.3 Spare Parts	6.2
6.1.4 Important User Information	6.2
6.2 Test Equipment	6.2
6.2.1 List of Test Equipment	6.3

(Continuation)---

D I G I T A L L Y T U N E D F I L T E R
F K 8 5 2 P 2

Repair Manual

Part 0: List of Contents

- 0.2 -

---(Continuation) List of Contents

		Page
6.3	Troubleshooting Flowchart	6.3
6.3.1	General	6.3
6.4	Measurements, Alignments and Functional Checks	6.10
6.4.1	Checking Gain	6.10
6.4.2	Setting AGC Response	6.10
6.4.3	Setting BITE Threshold	6.10
6.4.4	Alignment of Tuning Capacitor	6.11
6.4.5	Alignment of Bands	6.11
6.5	Replacing Components	6.12
6.6	Final Inspection	6.12
6.6.1	Current Consumption	6.12
6.6.2	Gain	6.12
6.6.3	Checking Bandpass	6.12
6.6.4	Checking Signal Path ($0.4 < f < 1.5$ MHz)	6.13
6.6.5	Filter Values	6.13
6.6.6	Checking Intermodulation	6.13
6.6.7	Checking Noise Figure	6.13
6.6.8	Checking AGC Response	6.14
6.6.9	Checking Overvoltage Protection	6.14
6.6.10	Checking BITE Threshold	6.14
6.7	External Interfaces	6.15

L I S T O F F I G U R E S

Fig.	Title	Page
5.1	Digitally tuned Filter FK 852P2, Block Diagram	5.5
6.1	Digitally tuned Filter FK 852P2, Troubleshooting Flowchart ...	6.4
6.2	Typical Frequency Response of Bandpass	6.17
6.3	Test Set-up for measuring Intermodulation	6.19
6.4	Test Set-up for measuring Noise Figure	6.21
6.5	Test Set-up for Overvoltage Protection	6.23
6.6	Test Set-up for Measuring Bandpass	6.25

Appendix *****

Circuit diagram	647.0019 S
Parts list	647.0019 SA
Components layout	647.0019

D I G I T A L L Y T U N E D F I L T E R
F K 8 5 2 P 2

Repair Manual

Part 5: Description of Function

- 5.1 -

5. Description of Function

See circuit diagram 647.0019 S for 5.1 to 5.8.

5.1 Received-signal Path
(0.4 < f < 1.5 MHz)

In reception the RF signal from the antenna is fed via connector X52 to the lowpass filter L30 and C90, C91, which blocks the receive path against signals of more than 100 MHz. In the continuation of the signal path there are the relay contacts K35, K36 and K31, cables W5 and W6 plus a Cauer bandpass filter for the frequency range 0.4 to 30 MHz. The signal is then applied via break plug X1, the relay contact K30 (4,7), a Cauer lowpass filter, the relay contacts K20 (4,7) and K33 (1,4) and the coupling capacitor C30 to the 9-dB amplifier V25. The Cauer lowpass filter consists of the capacitors C120 through C127 plus the coils L14 and L15. Its cutoff frequency is at approx. 1.5 MHz. Amplifier V25 is a common-base circuit and compensates for the losses produced by the preceding filter. The boosted signal is then fed via cables W2 and W3 to connector X55, from where it is applied to the Tx/Rx Section GX 852P1.

5.2 Received-signal Path
(f = 1.5 to 30 MHz)

When signals in the range 1.5 to 30 MHz are received, the signal path as far as the relay contact K30 (4,1) is identical to that of 5.1 above. However, in this case relay K30 is cut in and the received signal is applied via cable W8 to a filter made up of nine suboctaves.

Within these suboctaves the resonant frequency of the individual circuit can be tuned quasicontinuously. The combination of input and output capacitors produces a transformation of the low input and output impedance to high-impedance values.

In high-impedance filter circuits it is possible to achieve a substantial improvement in the quality of the individual filters. The groups of relays or capacitors are designated so that their relationship or association is easily recognized. For the lowest suboctave (1.5 to 2.1 MHz) for example, the relays K1 and K21 are always effective in conjunction with relay K11, which cuts in the corresponding inductance. Following this pattern therefore, the relays K9, K29 and K19 are cut in for the highest suboctave (24 to 30 MHz). The coupling capacitors C50, C60, C70 and C80 are cut in by the relays K38 and K48, K39 and K49. Relays K41 through K46 cut in the parallel capacitors C81 to C97 and C196, which are assigned to the suboctaves.

At the output of the filter the signal is fed via relay contact K20 (4,1), the 9-dB amplifier V25 and line W3 to connector X55, from where it is applied to the Tx/Rx Section GX 852P1.

5.3 Received-signal Path for
Very Large RF Signals
(> 5 V)

Following the input filter C90, C91 and L30 the received RF signal is fed via a fullwave rectifier to the input pins 6 and 7 of comparator N4. The reference input of the latter is pin 8.

When there are input voltages > 5 V on connector X52, comparator N4 will produce positive potential at its output 14, causing relay K36 to deenergize. The associated contacts K36 cut in the 40-dB attenuator R123 and R124. In this way the bandpass filter and sub-

(Continuation)---

D I G I T A L L Y T U N E D F I L T E R
F K 8 5 2 P 2

Repair Manual

Part 5: Description of Function

- 5.2 -

---(Continuation) Received-signal Path
 for Very Large RF Signals (> 5 V)

sequent components are protected against overvoltages and possible destruction. For servicing purposes there is a testpoint MP1 on pin 14 of comparator N4.

5.4 Received-signal Path for
Frequencies < 400 kHz

When signals are received at frequencies of less than 400 kHz, the band-pass filter and amplifier V25 are bypassed by relay contact K31a (4,8).

5.5 RF Gain Control

The AGC voltage from the Tx/Rx Section GX 852P1 is applied via connector X51.a21 to pin 6 of amplifier N1. The reference voltage, which can be set with potentiometer R100, is fed to the amplifier at pin 5. The following amplifier N1.1 boosts the control voltage and takes it to the PIN diodes V60 and V61. Depending on the value of the control voltage the diodes will conduct and attenuate the received signal as much as 15 dB.

5.6 Transmitted-signal Path

The signal flow through the selective filter is almost the same in transmission as in reception, except that it is in the reverse direction of course. Proceeding from the Tx/Rx Section GX 852P1, the transmitted signal is fed in via connector X53 and applied via cable W1, contact K33 (7,4), the 9-dB amplifier V25, contact K20 (4,1), contact K30 (4,1) to the break plug X1. In the continuation of the signal path there are the Cauer bandpass filter, cable W6, contact K31b (13,9), cable W7 and connector X54. From there the signal is fed to the RF power amplifier. For the monitoring of the transmitted-signal path in the filter, part of the signal

is derived via amplifier N2 and rectifier V58 and applied to comparator N3. If the strength of the signal is sufficient, the Q output of comparator N3 goes from High to Low and a GO signal is output via connector X51.a5 to the Processor GS 852P1. The reference voltage of comparator N3 can be set with resistor R80.

5.7 Data Input

The Filter FK 852P2 is driven via connector X51, pins a6, a7, a9 and a19. Input a18 produces the T/R switchover.

Pins a10 to a16 are data inputs for setting the required filter band. The input data are fed to the D flipflops D1 to D4. The BCD/decimal decoder D5 converts the BCD code at its inputs 10 to 13 into a 1-out-of-19 output code. The line drivers D6 to D8 drive the switching transistors V1 to V9 and V13 to V21, and these switch the associated relays.

5.8 Test Mode

In the test mode, i.e. when the BITE signal from the Processor GS 852P1 is read in, the data input X51.a10, X51.a11 and the strobe-9 input X51.a9 are driven with a High level. The driver output D8.1 switches a Low level to comparator N4.12. The comparator output N4.14 is thus sent to +15 V. Relay K36 deenergizes and with its contacts cuts in the 40-dB attenuator R123 and R124. The driver output D8.3 energizes relay K35. Contact K35 (8,4) disconnects the receiving antenna from the signal path and contact K35 (9,13) enables the test path. Driver D8.3 also energizes relay K34, which cuts in the 20-dB attenuator R18 to R20 for level matching.

(Continuation)---

D I G I T A L L Y T U N E D F I L T E R
F K 8 5 2 P 2Repair Manual
Part 5: Description of Function- 5.3 -

---(Continuation) Test Mode

In the test mode a 900-kHz line spectrum with a bandwidth of 30 MHz is fed as a simulated antenna signal through the Digitally Tuned Filter FK 852P2. The test signal is fed from connector X56 via the 40-dB attenuator to the Causer bandpass filter. In continuation of this the signal is routed through the previously set filter band, the

9-dB amplifier V25, the 20-dB attenuator and output X55 to the Tx/Rx Section GX 852P1.

The test result is evaluated by the Processor GS 852P1. Upon termination of the test mode the processor will switch the HF transceiver back to the previously set operating status.

D I G I T A L L Y T U N E D F I L T E R
F K 8 5 2 P 2

Repair Manual
Part 6: Repair

- 6.1 -

6. Repair

See circuit diagram, parts list and component layouts in the appendix to this repair manual (list on page 0.2).

6.1 Preliminary Remarks

The repair of the Digitally Tuned Filter FK 852P2 consists of troubleshooting and fault elimination, of measurements, alignments and functional checks, of replacing assemblies and components as well as of a final inspection.

All the information required for repairing the filter down to component level is given in this section.

For all alignment work and measurements the filter has to be supplied with the operating voltages given in the circuit diagram 647.0019S.

All RF measurements on the filter are to be performed with the covers screwed down in place; if necessary, a special test cover must be produced for the purpose.

In RF measurement one must also ensure that cables and connections have the right characteristic impedance and that the connecting leads are as short as possible.

Among the components incorporated in the filter there are MOS, MOSFET and CMOS devices. Devices of this kind are extremely sensitive to high extraneous voltages. Static discharge can produce very high voltage spikes, which are capable of destroying these devices.

For this reason, when work is being carried out in the vicinity of these devices, i.e. unless a special CMOS work station is available, the following minimum requirements should be observed:

- conductive bench and floor coverings
- chair or stool with conductive coverings
- grounded, metallic work surface and conductive wrist-straps with a resistance of $> 200 \text{ kohms}$, $< 1 \text{ Mohm}$ plus an insulated lead and plug
- soldering irons with safety grounding
- all conductive surfaces, wrist-straps and work surfaces must be interconnected by insulated leads
- supply voltages must be disconnected when soldering is being performed

In general:

When performing any electrical or mechanical repairs on the Digitally Tuned Filter FK 852P2, only disassemble the unit to the extent necessary for the performing of these repairs.

6.1.1 Troubleshooting Instructions

Any fault that occurs should be localized with the aid of the troubleshooting flowchart given in 6.3.

DIGITALLY TUNED FILTER
FK 852P2

Repair Manual
Part 6: Repair

- 6.2 -

6.1.2 Restoring the Nominal Characteristics

Any component that is definitely proved to be defective - through use of the troubleshooting flowchart or by performing the alignments, measurements and functional checks - should only be replaced by a component that meets the specifications given in the parts list in the appendix to this repair manual.

Only in this way can the technical data be guaranteed that are given in section 1 of the user manual.

Once components have been replaced, it is absolutely essential that the final inspection detailed in chapter 6.6 is performed.

6.1.3 Spare Parts

All components and assemblies are subjected to strict quality assurance before they are allowed to be used in this item of equipment.

For components from outside suppliers, e.g. resistors, capacitors, diodes, transistors and integrated through to highly integrated circuits, R&S has set down its own delivery specifications for the purpose of ensuring maximum reliability. For this reason we recommend that only original spare parts are used, for replacing defective components.

When ordering a spare part, please state the following:

Type, ordering code and serial number of equipment, stock number of the parts list and designation plus stock number of the component concerned.

All of these details are to be found in the circuit diagram, parts list and components layout that accompany the manual.

6.1.4 Important User Information

The following contains details which are essential when referring to Part 6 "Repair". This is in order to prevent misunderstandings at a later stage.

- All voltage measurements are referred to ground, if not stated otherwise.
- Abbreviations in the text, such as ST1.2, BU3.5a and B6.7 are to be understood as follows:

Plug 1 - Pin 2

Socket 3 - Pin 5a

Integrated Circuit 6 - Pin7

- Every component mentioned is contained in Circuit Diagram 647.0019S. There are therefore no special references to this circuit diagram in the text.
- The repair of the Digitally Tuned Filter FK 852P2, model 02, is identical to the repair of model 05. Therefore in the following text no further reference is made to the different models.

6.2 Test Equipment

The test equipment given in the following list will be required for performing the repairs described in this section of the manual.

Equivalent items of test equipment can be used, of course, provided that their technical data are at least as good.

DIGITALLY TUNED FILTER
FK 852P2

Repair Manual
Part 6: Repair

- 6.3 -

6.2.1 List of Test Equipment

No.	Test equipment, required data	Recommended R&S unit	Ordering code
1	Mobile tester	SMFP 2	332.0015.53
2	Power signal generator, $V_{out} = 0$ to 10 V EMF into 50 ohms, 0.1 to 30 MHz		
3	Signal generator, 10 Hz to 30 MHz	SMK	348.0010.02
4	Test receiver, 9 kHz to 30 MHz -30 to +137 dB(μ V)	ESH 2	303.3030.52
5	Spectrum analyzer, 0.1 to 100 MHz, sensitivity > -80 dBm, level display range 80 dB		
6	RF millivoltmeter with RF insertion unit 10 V/50 ohms and precision termination 50 ohms	URV 4 URV-Z2 RNA	292.5012.03 288.8010.55 272.4510.50
7	Noise generator, 20 Hz to 30 MHz	SUF 2	282.8819.03
8	Digital multimeter	UDL 33	388.8011.02
9	2 RF attenuators, 0 to 10 dB	DPSP	334.6010.02
10	Power combiner, 0.1 to 30 MHz	DVS	342.1014.50
11	2 buffer amplifiers, A = 17 dB, $V_{out max} = 25$ dBm		
12	Polyscope, 0 to 30 MHz with 2 log amplifiers 2 demodulators VSWR bridge	SWOB 5 SWOB 5 E3 SWOB 5 Z1 ZRB 2	333.0019.53 349.3512.02 333.7513.52 373.9017.52
13	Service kit	KA 852 C1	648.8513.02

6.3 Troubleshooting Flowchart6.3.1 General

The following troubleshooting flowchart (Fig. 6.1) covers troubleshooting as well as the elimination of faults in the Filter FK 852P2.

To make the troubleshooting as straightforward as possible, there

are, where necessary, cross-references to other measurements and procedures involved in repair. The given sequence for the troubleshooting should be adhered to so that faults can be detected and remedied as speedily and rationally as possible.

DIGITALLY TUNED FILTER
FK 852P2

Repair Manual
Part 6: Repair

- 6.4 -

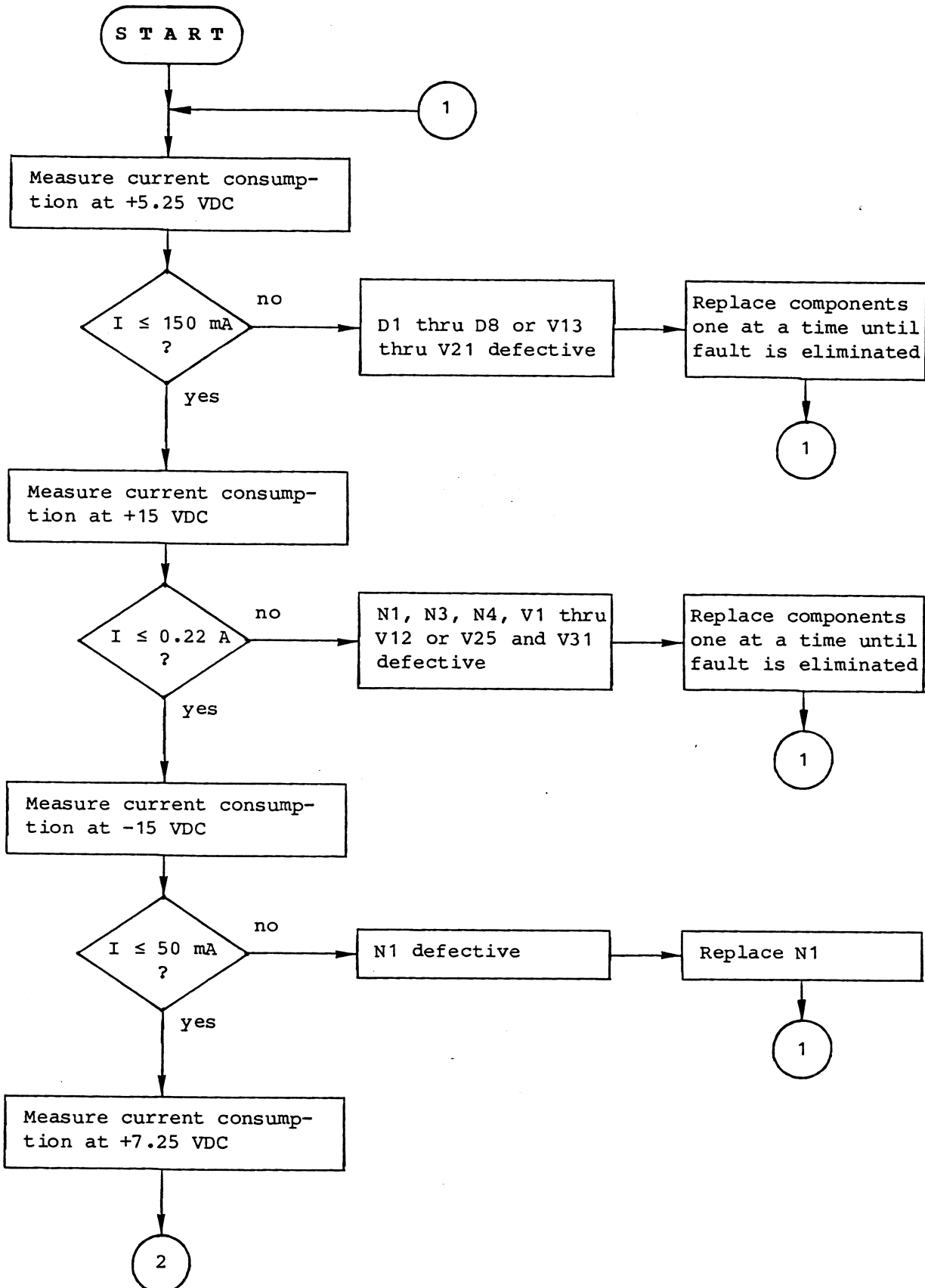

Fig. 6.1 Digitally Tuned Filter FK 852P2, Troubleshooting Flowchart
(page 1 of 6)

DIGITALLY TUNED FILTER
FK 852P2

Repair Manual
Part 6: Repair

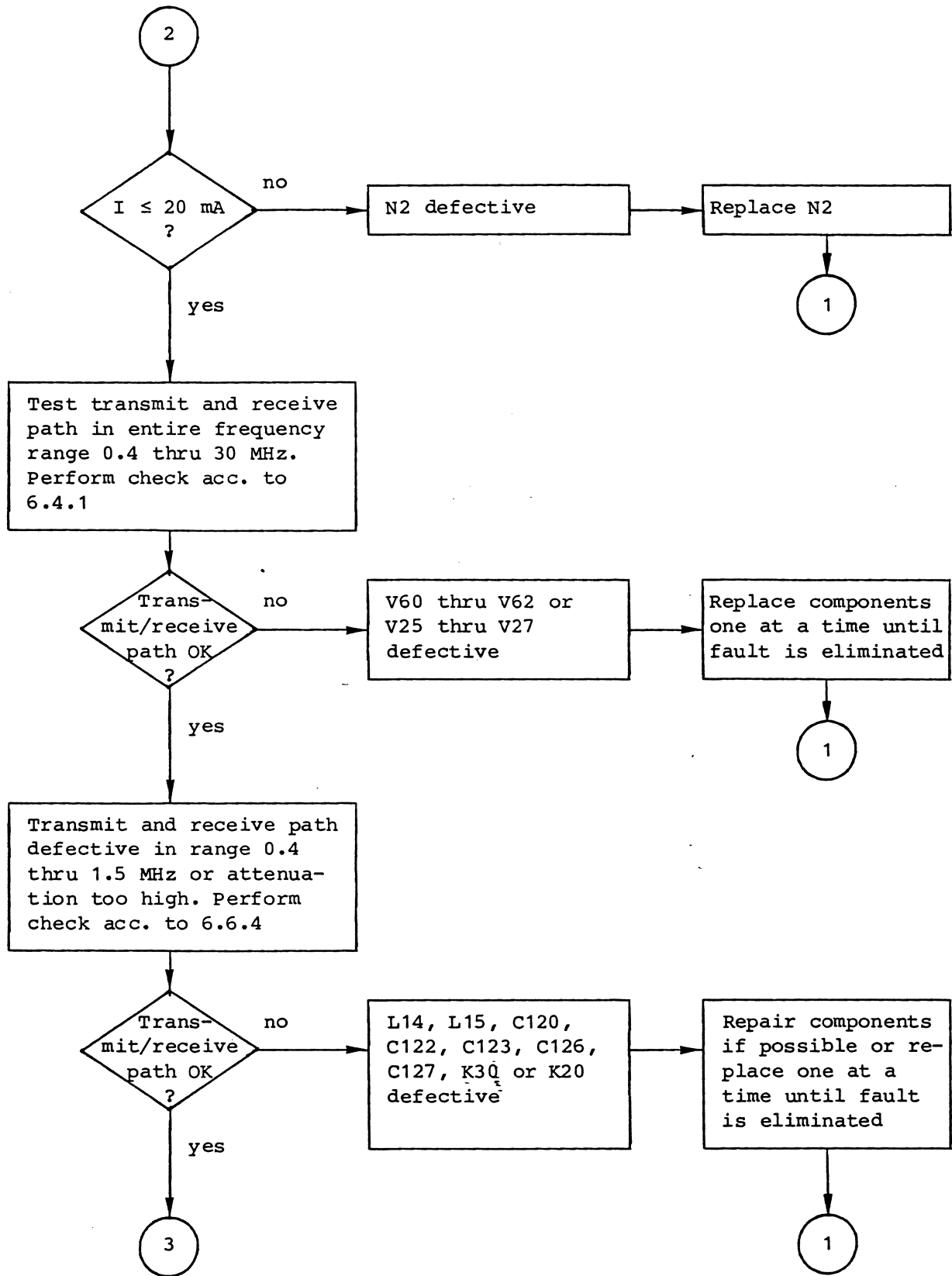

Fig. 6.1 Digitally Tuned Filter FK 852P2, Troubleshooting Flowchart (page 2 of 6)

DIGITALLY TUNED FILTER
FK 852P2

Repair Manual
Part 6: Repair

- 6.6 -

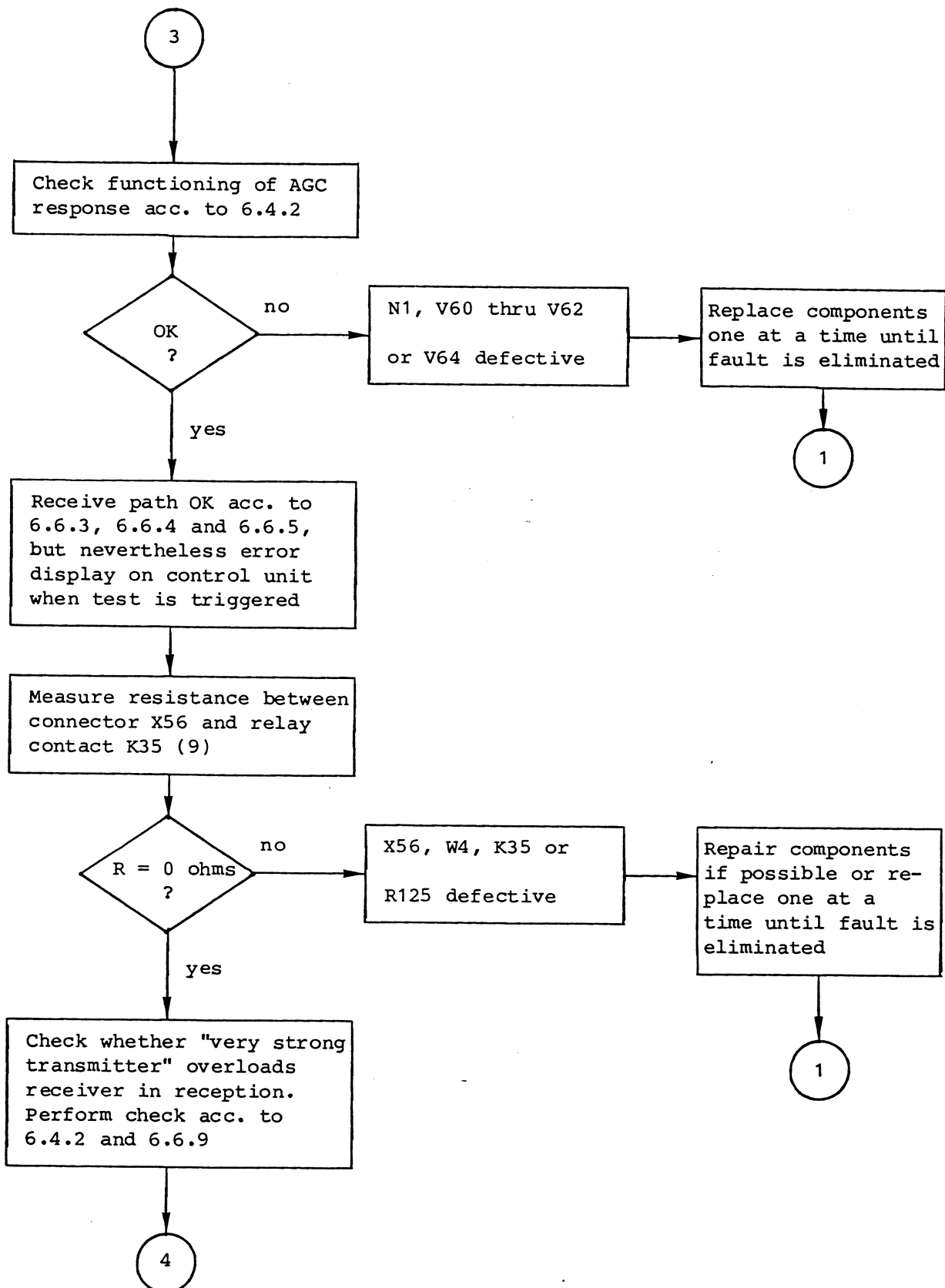

Fig. 6.1 Digitally Tuned Filter FK 852P2, Troubleshooting Flowchart
(page 3 of 6)

DIGITALLY TUNED FILTER
FK 852P2

Repair Manual
Part 6: Repair

- 6.7 -

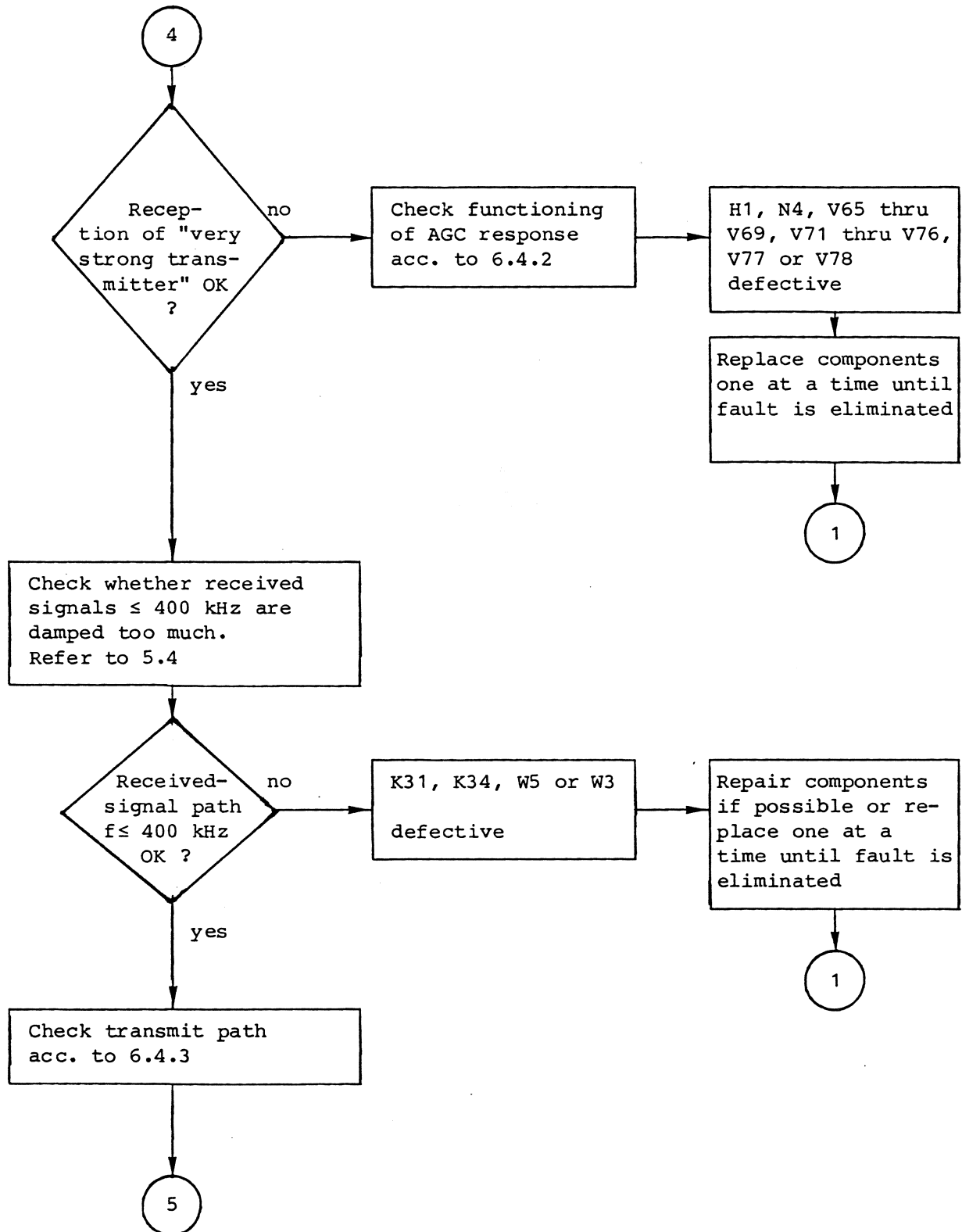

Fig. 6.1 Digitally Tuned Filter FK 852P2, Troubleshooting Flowchart
(page 4 of 6)

DIGITALLY TUNED FILTER
FK 852P2

Repair Manual
Part 6: Repair

- 6.8 -

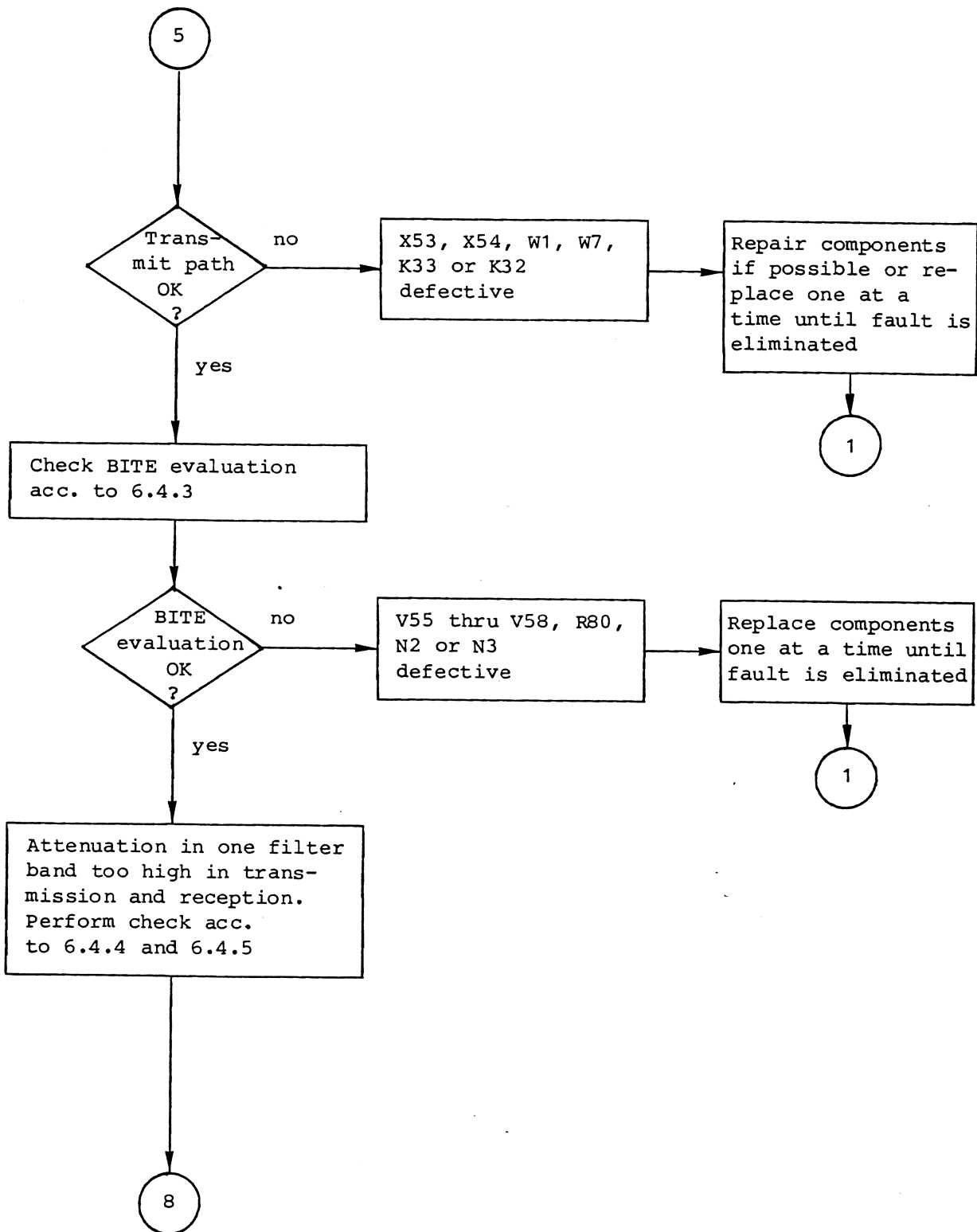
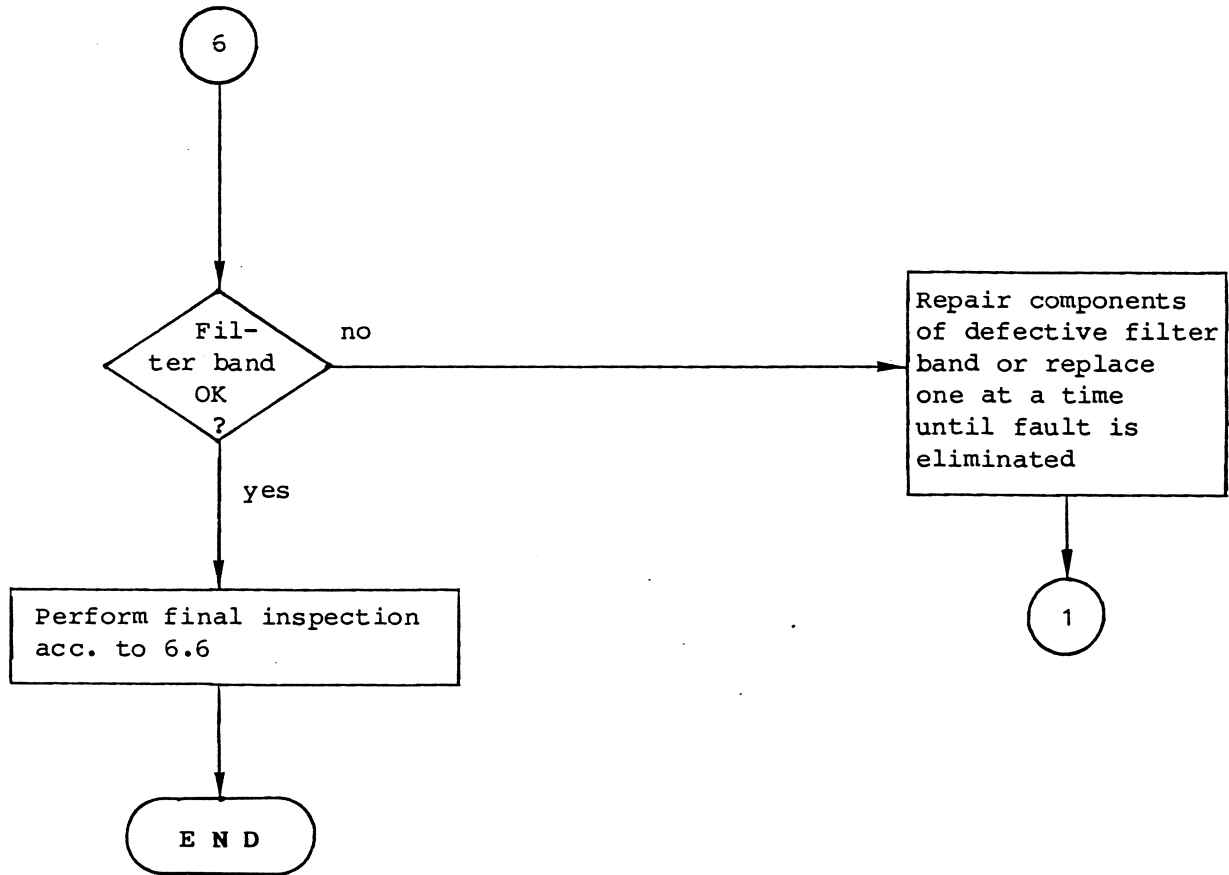

Fig. 6.1 Digitally Tuned Filter FK 852P2, Troubleshooting Flowchart
(page 5 of 6)

DIGITALLY TUNED FILTER
FK 852P2Repair Manual
Part 6: Repair

- 6.9 -

Fig. 6.1 Digitally Tuned Filter FK 852P2, Troubleshooting Flowchart
(page 6 of 6)

D I G I T A L L Y T U N E D F I L T E R
F K 8 5 2 P 2

Repair Manual
Part 6: Repair

- 6.10 -

6.4 Measurements, Alignments and
Functional Checks

The measurements, alignments and functional checks that are described below are the more detailed procedures to the instructions given in a condensed form in the troubleshooting flowchart. Consequently one will usually undertake these measurements, alignments and functional checks by branching out of the troubleshooting flowchart at a particular point. When the measurement, etc. has been performed, one returns to the troubleshooting flowchart at the same point where one previously left it.

If a fault has been clearly identified beforehand however, one can of course commence with one of these measurements, etc. directly.

For all of these measurements or tests it is assumed that the Digitally Tuned Filter FK 852P2 is properly adapted to an HF transceiver. For opening the filter, refer to 6.5.

6.4.1 Checking Gain

1. Set the OPERATION MODE switch on the control unit to Rx.
2. In the Filter FK 852P2 remove the break plug X18 and connect X82-X83.
3. The test setup is as in Fig. 6.6, but connect the VSWR bridge to connector X53 (level = 13 dBm) and the demodulator to connector X54.

Nominal value of gain in range 0.4 to 30 MHz:

$$A = 9 \pm 0.5 \text{ dB}$$

4. After testing, replace the break plug X18.

6.4.2 Setting AGC Response

1. Set the OPERATION MODE switch on the control unit to Rx and enter a frequency of 10000.0 kHz.
2. Connect a signal generator ($f = 10 \text{ MHz}$, $V_{\text{out}} = -70 \text{ dBm}$) to connector X52 and an RF millivoltmeter with an insertion unit to connector X55. (The connection between X55 and the Tx/Rx Section GX 852P1 must be retained.)
3. Connect a digital multimeter to connector X51.a21.
4. Increase the level of the signal generator until the digital multimeter displays $4 \pm 0.1 \text{ V}$ (response point).
5. Note the indication on the RF millivoltmeter for this condition. If necessary, correct the response point (-0.5 dB referred to the output level of the signal generator) using potentiometer R100. Then increase the RF level on connector X52 until the DMM displays $6 \pm 0.1 \text{ V}$.
6. Read the indication on the RF millivoltmeter. The difference between the two read levels produces the controlling attenuation.

Nominal value: $a \geq 15 \text{ dB}$

6.4.3 Setting BITE Threshold

1. Set the OPERATION MODE switch on the control unit to Tx and enter a frequency of 10000.0 kHz.
2. Connect the signal generator to connector X53 and a test receiver to connector X54.

(Continuation)---

DIGITALLY TUNED FILTER
FK 852P2

Repair Manual
Part 6: Repair

- 6.11 -

---(Continuation) Setting BITE
threshold

3. Set the signal generator to 10 MHz and increase its output level until there is a level of 7 dBm at output X54.
4. The BITE output, connector X51.a5, must switch to Low. Correct by means of potentiometer R80 if necessary.

6.4.4 Alignment of Tuning Capacitor

1. Set the OPERATION MODE switch on the control unit to Rx.
2. Connect the signal generator (approx. 0 dBm) to connector X52 and the test receiver to connector X55.
3. Set the signal generator to each of the frequencies given in Table 1. Set the same frequencies on the control unit.
4. Then, for 2115.0 kHz for example, adjust the indication on the test receiver to maximum using, for example, C181.

f (kHz)	Adjust to maximum with
2115.0	C181
2087.0	C81
2060.0	C82
2009.0	C83
1917.5	C84
1713.0	C86
1590.5	C85

6.4.5 Alignment of Bands

1. Set the OPERATION MODE switch on the control unit to Rx.
2. Connect the signal generator (approx. 0 dBm) to connector X52 and the test receiver to connector X55.
3. Set the signal generator to each of the frequencies given in Table 2. Set the same frequencies on the control unit.
4. Tune the resonant circuit of each band by adjustment with the toroidal-core or air-core coil at the lower band limit and adjustment of the trimmer capacitor at the upper band limit. In doing this the indication on the test receiver is to be brought to maximum.

Band	Frequency (kHz)	Adjust to maximum with
II	2138.0	L2
II	2976.0	C182
III	3023.0	L3
III	4230.0	C183
IV	4276.0	L4
IV	5972.0	C184
V	6046.0	L5
V	8460.0	C185
VI	8552.0	L6
VI	11904.0	C186
VII	12092.0	L7
VII	16920.0	C187
VIII	17104.0	L8
VIII	23808.0	C188
IX	24184.0	L9
IX	29700.0	C189

5. Following this alignment the coils must be retained again with cable binders.

D I G I T A L L Y T U N E D F I L T E R
F K 8 5 2 P 2

Repair Manual
Part 6: Repair

- 6.12 -

6.5 Replacing Components

Before components can be replaced, the filter has to be opened. Proceed as follows:

1. Remove the top RF cover after undoing the seven Phillips screws.
2. Remove the bottom RF cover after undoing the six Phillips screws.

Before the LC board can be removed, seven Phillips screws have to be undone. Then lift up the LC board (plugged connection).

Components are replaced by following usual workshop procedure. No special instructions are necessary for this.

When components have been replaced, proceed once again with the troubleshooting according to Fig. 6.1.

6.6 Final Inspection

After a repair has been carried out, the Filter FK 852P2 must be subjected to the following final inspection to ensure that its technical data can still be guaranteed.

If this final inspection does not prove satisfactory, the testing and troubleshooting following the flow-chart Fig. 6.1 will have to be performed again. Repeat the procedure as many times as is necessary to detect and remedy all faults.

6.6.1 Current Consumption

+15 VDC ≤ 220 mA
+5.25 VDC ≤ 150 mA
-15 VDC ≤ 50 mA
+7.25 VDC ≤ 20 mA

6.6.2 Gain

1. Set the OPERATION MODE switch on the control unit to Rx.
2. In the Filter FK 852P2 remove the break plug X18 and connect X82-X83.
3. The test set-up is as in Fig. 6.6, but connect the VSWR bridge to connector X53 (level = 13 dBm) and the demodulator to connector X54.

Nominal value of gain in range 0.4 to 30 MHz:

$$A = 9 \pm 0.5 \text{ dB}$$

4. After testing, replace the break plug X18.

6.6.3 Checking Bandpass

1. Set the OPERATION MODE switch on the control unit to Rx.
2. Arrange a test set-up acc. to Fig. 6.6.
3. Set the level of the signal generator to 0 dBm.
4. Remove break plug X11.

Nominal values of attenuation:

400 kHz ≤ f ≤ 30 MHz a ≤ 1 dB
f = 45 MHz a ≥ 15 dB
f = 50 MHz a ≥ 25 dB
f = 90 MHz a ≥ 50 dB

Note:

Fig. 6.2 illustrates the typical frequency response.

D I G I T A L L Y T U N E D F I L T E R
F K 8 5 2 P 2

Repair Manual
Part 6: Repair

- 6.13 -

6.6.4 Checking Signal Path
($0.4 < f < 1.5$ MHz)

1. Set the OPERATION MODE switch on the control unit to Rx.
2. Arrange a test set-up acc. to Fig. 6.6, but connect demodulator to connector X55 (level = 0 dBm).

Nominal values of attenuation in range 0.4 to 1.5 MHz:

$$a \leq 2.5 \text{ dB}$$

6.6.5 Filter Values

1. Set the OPERATION MODE switch on the control unit to Rx.
2. Arrange a test set-up acc. to Fig. 6.6, but connect filter output X55 in place of X1.
3. Set the level of the signal generator to 0 dBm.
4. Select a filter band acc. to table 2 in 6.4.5 and enter its centre frequency on control unit.

Example:

For band II set following on Polyscope:

Lower band limit 2.138 MHz -14%

Upper band limit 2.976 MHz +14%

Nominal value at -14% frequency margin from lower limit frequency:

$$a \geq 15 \text{ dB}$$

Nominal value at +14% frequency margin from upper limit frequency:

$$a \geq 15 \text{ dB}$$

The reference value is the particular attenuation at the tuning frequency.

6.6.6 Checking Intermodulation

1. Arrange a test set-up acc. to Fig. 6.3.
2. Set the OPERATION MODE switch on the control unit to Rx.
3. Signal generator 1 set for $f_1 = 29.9$ MHz
4. Signal generator 2 set for $f_2 = 30$ MHz.
5. Tune level on connector X52 for each signal, f_1 and f_2 , to 7 dBm.

Margin of intermodulation products:

$$\geq 42 \text{ dB}$$

6.6.7 Checking Noise Figure

1. Arrange a test set-up acc. to Fig. 6.4.
2. Set the OPERATION MODE switch on the control unit to Rx.
3. Set level on noise generator to zero.
4. Tune test receiver to 10 MHz and insert a 3-dB attenuator pad.
5. Read indication on test receiver and note.
6. Then increase attenuation to 6 dB.
7. Increase level on noise generator until same reading is indicated on test receiver as previously.
8. Indication on noise generator produces noise figure F.

Nominal value at $f = 10$ MHz:

$$F \leq 3 \text{ kt}_0$$

DIGITALLY TUNED FILTER
FK 852P2

Repair Manual
Part 6: Repair

- 6.14 -

6.6.8 Checking AGC Response

Check the AGC response acc. to 6.4.2.

Check this at following frequencies:

f = 1 MHz
f = 10 MHz
f = 29.9 MHz

6.6.9 Checking Overvoltage Protection

1. Arrange a test set-up acc. to Fig. 6.5.

2. Set the OPERATION MODE switch on the control unit to Rx.

3. Remove break connector X11 and terminate connector X1 with 50 ohms.

4. Measure at testpoint MP1 with digital multimeter.

5. Comparator N4 flips when output 14 (testpoint MP1) shows

≥ 15 VDC.

6. Nominal value of response threshold corresponds to RF voltage of 2.5 to 5 V on connector X52.

7. Afterwards re-insert break connector X11.

6.6.10 Checking BITE Threshold

1. Set the OPERATION MODE switch on the control unit to Tx and enter a frequency of 10000.0 kHz.

2. Connect the signal generator to connector X53 and a test receiver to connector X54.

3. Set the signal generator to 10 MHz and increase its output level until there is a level of 7 dBm at output X54.

4. The BITE output, connector X51.a5, must switch to Low. Correct by means of potentiometer R80 if necessary.

D I G I T A L L Y T U N E D F I L T E R
F K 8 5 2 P 2

Repair Manual
 Part 6: Repair

- 6.15 -

6.7 External Interfaces

Plug X51	Pin	Signal designation/level
FP connector strip, 32-way, for printed circuits, <div style="text-align: center;"> </div>	a1	Not used
	a2	Not used
	a3	Not used
	a4	Not used
	a5	BITE Selection (TTL)
	a6	Strobe 3 (TTL)
	a7	Strobe 4 (TTL)
	a8	Not used
	a9	Strobe 9 (TTL)
	a10	Data 0 (TTL)
	a11	Data 1 (TTL)
	a12	Data 2 (TTL)
	a13	Data 3 (TTL)
	a14	Data 4 (TTL)
	a15	Data 5 (TTL)
	a16	Data 6 (TTL)
	a17	Data 7 (TTL)
	a18	Transmit
	a19	Not used
	a20	Not used
	a21	AGC RF (0 to 6 V)
	a22	Not used
	a23	-15 VDC
	a24	+5.3 VDC
	a25	+5.3 VDC
	a26	+7.25 VDC
	a27	+7.25 VDC
	a28	+15 VDC
	a29	+15 VDC
	a30	Ground
	a31	Ground
	a32	Ground

Plugs X52 thru X56	Pin	Signal designation/level
FJ fixed connector system SMB <div style="text-align: center;"> </div>	X52	HF Reception 1
	X53	HF Transmission 2
	X54	HF Transmission 1
	X55	HF Reception 2
	X56	Test spectrum

DIGITALLY TUNED FILTER
FK 852P2

Repair Manual
Part 6: Repair

NOTES



ROHDE & SCHWARZ

Communications Division

Appendix

CIRCUIT DIAGRAMS

PARTS LISTS

COMPONENTS LAYOUTS

Für diese Unterlage behalten wir
uns alle Rechte vor

Kennz. Comp.No.	Benennung Designation	Sachnummer Stock No.	Hersteller Manufacturer	Bezeichnung Designation	enthalten in contained in	
	VARIANTENERKL. / VERSIONS VAR 02 = GRUNDAUSFUEHRUNG MOD 02 = BASIC MODEL VAR 03 = AUSFUEHRUNG MIT S/E-UMSCHALTUNG MOD 03 = MODEL WITH TX/RX SWITCH-OVER VAR 05 = AUSF. EKO85 MOD 05 = MODEL EKO85					
A5.1	ED GRUNDPLATTE MAIN BOARD HIERZU STROML.647.0019.01S SEE CIRC.DIA.647.0019.01 S	647.0025.03				
A5.2	ED LC-PLATTE LC BOARD HIERZU STROML.647.0019.01S SEE CIRC.DIA.647.0019.01 S	647.0054.02				
W90	DY FLACHBANDKABEL 64POL. RIBBON CABLE 64-WAY NUR VAR/ONLY MOD: 05	651.7550				
X14	FP KURZSCHLUSSBUCHSE SHORTING PLUG NUR VAR/ONLY MOD: 02 03 05	FP 491.7042	PK	452-70302		
X15	FP KURZSCHLUSSBUCHSE SHORTING PLUG NUR VAR/ONLY MOD: 02 03 05	FP 491.7042	PK	452-70302		
- ENDE -						
ROHDE & SCHWARZ		Äl	Datum Date	Schaltteilliste für Parts list for	Sachnummer Stock No.	Blatt Page
		15	0593	FK852P2 DIGIT.ABGEST.SEL. FK852P2 DIGIT.-TUN.FILTER	647.0019.01 SA	1-

Kennz. Comp.No.	Benennung Designation	Sachnummer Stock No.	Hersteller Manufacturer	Bezeichnung Designation	enthalten in contained in	
	VARIANTENERKL. / VERSIONS VAR 02 = GRUNDAUSFUEHRUNG MOD 02 = BASIC MODEL VAR 03 = AUSFUEHRUNG MIT S/E-UMSCHALTUNG MOD 03 = MODEL WITH TX/RX SWITCH OVER VAR 05 = AUSF. EK085 MOD 05 = MODEL EK085					
C1	CC 1NF+-10%200V5K1200VIEL	CC 068.4047	UNION CARB	CK05BX102K		
..11	CAPACITOR					
C13	CE RICHTIG SNR.0008.7510 ELECTROLYTIC CAPACITOR	CE 006.7165	ROEDERST	EK 00CB 310 D		
C14	CC 100NF+-10%50V5K1200VIE CAPACITOR	CC 084.5350	UNION CARB	CK05BX104K		
C15	CE 47UF+-20%63V RM5 ELECTROLYTIC CAPACITOR	008.7440	ROE	EKE00 CC247JG		
C16	CC 100NF+-10%50V5K1200VIE CAPACITOR	CC 084.5350	UNION CARB	CK05BX104K		
C17	CE 47UF+-20%63V RM5 ELECTROLYTIC CAPACITOR	008.7440	ROE	EKE00 CC247JG		
C18	CC 100NF+-10%50V5K1200VIE CAPACITOR	CC 084.5350	UNION CARB	CK05BX104K		
C20	CC 100NF+-10%50V5K1200VIE CAPACITOR	CC 084.5350	UNION CARB	CK05BX104K		
..25	CAPACITOR					
C26	CC 1UF+-10%50V7K1200VIEL CAPACITOR	084.5538	UNION CARB	CK06BX105K		
C27	CC 1UF+-10%50V7K1200VIEL CAPACITOR	084.5538	UNION CARB	CK06BX105K		
C29	CC 100NF+-10%50V5K1200VIE CAPACITOR	CC 084.5350	UNION CARB	CK05BX104K		
C30	CC 100NF+-10%50V5K1200VIE CAPACITOR	CC 084.5350	UNION CARB	CK05BX104K		
C32	CC 100NF+-10%50V5K1200VIE CAPACITOR	CC 084.5350	UNION CARB	CK05BX104K		
C33	CC 100NF+-10%50V5K1200VIE CAPACITOR	CC 084.5350	UNION CARB	CK05BX104K		
C34	CC 100NF+-10%50V5K1200VIE CAPACITOR	CC 084.5350	UNION CARB	CK05BX104K		
C35	CE 10 UF+-20%25V 7X 5X11 ELECTROLYTIC CAPACITOR	CE 023.5980	ROEDERSTEI	ETR 3 10/25 20%		
C36	CE 10 UF+-20%25V 7X 5X11 ELECTROLYTIC CAPACITOR	CE 023.5980	ROEDERSTEI	ETR 3 10/25 20%		
C37	CC 100NF+-10%50V5K1200VIE CAPACITOR	CC 084.5350	UNION CARB	CK05BX104K		
C41	CG 820PF+-0,5%250V TK+70 MICA CAPACITOR	CG 006.9445	ASHCROFT	66 250V820PD+-0,5%		
C42	CG 680PF+-0,5%250V TK+70 MICA CAPACITOR	CG 006.9439	ASHCROFT	65 250V680PF+-0,5%		
C43	CG 560PF+-0,5%250V TK+70 MICA CAPACITOR	CG 006.9422	ASHCROFT	65 250V 560PF+-0,5%		
C44	CG 560PF+-0,5%250V TK+70 MICA CAPACITOR	CG 006.9422	ASHCROFT	65 250V 560PF+-0,5%		
C45	CG 330PF+-0,5%250V TK+70 MICA CAPACITOR	CG 006.9397	ASHCROFT	65 250V330PF+-0,5%		
C46	CG 270PF+-0,5%250V TK+70 MICA CAPACITOR	CG 006.9380	ASHCROFT	65 250V270PF+-0,5%		
C47	CG 220PF+-1% 250V TK+100 MICA CAPACITOR	CG 006.9374	ASHCROFT	67 250V 220PF+-1%		
C48	CG 56 PF+-1PF 250V TK+100 MICA CAPACITOR	CG 006.9300	ASHCROFT	67 250V 56PF+-1PF		
C49	CG 27 PF+-1PF 250V TK+100 MICA CAPACITOR	CG 006.9268	ASHCROFT	67 250V 27PF+-1PF		
C50	CG 27 PF+-1PF 250V TK+100 MICA CAPACITOR	CG 006.9268	ASHCROFT	67 250V 27PF+-1PF		
C60	CG 47 PF+-1PF 250V TK+100 MICA CAPACITOR	CG 006.9297	ASHCROFT	67 250V 47PF+-1PF		
C70	CG 27 PF+-1PF 250V TK+100 MICA CAPACITOR	CG 006.9268	ASHCROFT	67 250V 27PF+-1PF		
C71	CG 820PF+-0,5%250V TK+70 MICA CAPACITOR	CG 006.9445	ASHCROFT	66 250V820PD+-0,5%		
C72	CG 680PF+-0,5%250V TK+70 MICA CAPACITOR	CG 006.9439	ASHCROFT	65 250V680PF+-0,5%		
C73	CG 560PF+-0,5%250V TK+70 MICA CAPACITOR	CG 006.9422	ASHCROFT	65 250V 560PF+-0,5%		
C74	CG 560PF+-0,5%250V TK+70 MICA CAPACITOR	CG 006.9422	ASHCROFT	65 250V 560PF+-0,5%		
ROHDE & SCHWARZ		Äl	Datum Date	Schaltteilliste für Parts list for	Sachnummer Stock No.	Blatt Page
		34	0593	ED GRUNDPLATTE MAIN BOARD	647.0025.01 SA	1+

Kennz. Comp.No.	Benennung Designation	Sachnummer Stock No.	Hersteller Manufacturer	Bezeichnung Designation	enthalten in contained in
C75	CG 330PF+-0,5%250V TK+70 MICA CAPACITOR	CG 006.9397	ASHCROFT	65 250V330PF+-0,5%	
C76	CG 270PF+-0,5%250V TK+70 MICA CAPACITOR	CG 006.9380	ASHCROFT	65 250V270PF+-0,5%	
C77	CG 220PF+-1% 250V TK+100 MICA CAPACITOR	CG 006.9374	ASHCROFT	67 250V 220PF+-1%	
C78	CG 56 PF+-1PF 250V TK+100 MICA CAPACITOR	CG 006.9300	ASHCROFT	67 250V 56PF+-1PF	
C79	CG 27 PF+-1PF 250V TK+100 MICA CAPACITOR	CG 006.9268	ASHCROFT	67 250V 27PF+-1PF	
C80	CG 47 PF+-1PF 250V TK+100 MICA CAPACITOR	CG 006.9297	ASHCROFT	67 250V 47PF+-1PF	
C81 ..86	CT 9,2PF TAUCHTR.RD 7X12 AIR-TYPE TRIMMER	CT 025.7367	TEKELEC	AT 5200	
C90	CG 68PF+-5%300V 14X5X3 CAPACITOR	417.8426	JAHRE	49.46/68/5/250	
C91	CG 68PF+-5%300V 14X5X3 CAPACITOR	417.8426	JAHRE	49.46/68/5/250	
C92	CC 100NF+-10%50V5K1200VIE CAPACITOR	CC 084.5350	UNION CARB	CK05BX104K	
C93	CG 18 PF+-1PF 250V TK+100 MICA CAPACITOR	CG 006.9245	ASHCROFT	67 250V 18PF+-1PF	
C94	CG 39 PF+-1PF 250V TK+100 MICA CAPACITOR	CG 006.9280	ASHCROFT	67 250V 39PF+-1PF	
C95	CG 10 PF+-1PF 250V TK+100 MICA CAPACITOR	CG 006.9216	ASHCRAFT	67250V 10PF+-1PF	
C96	CG 68 PF+-1PF 250V TK+100 MICA CAPACITOR	CG 006.9316	ASHCROFT	67 250V 68PF+-1PF	
C97	CG 82 PF+-1PF 250V TK+100 MICA CAPACITOR	CG 006.9322	ASHCROFT	67 250V 82PF+-1PF	
C98	CC 100NF+-10%50V5K1200VIE CAPACITOR	CC 084.5350	UNION CARB	CK05BX104K	
C99	CC 10NF+-10%100V5K1200VIE CERAMIC CAPACITOR	CC 068.4060	UNION CARB	CK05BX103K	
C100	CC 68PF+-10%200V5K1200VIE CAPACITOR	CC 084.5238	UNION CARB	CK05BX680K	
C101	CC 10NF+-10%100V5K1200VIE CERAMIC CAPACITOR	CC 068.4060	UNION CARB	CK05BX103K	
C102	CC 10NF+-10%100V5K1200VIE CERAMIC CAPACITOR	CC 068.4060	UNION CARB	CK05BX103K	
C103	CE RICHTIG SNR.0008.7510 ELECTROLYTIC CAPACITOR	CE 006.7165	ROEDERST	EK OOCB 310 D	
C104	CC 100NF+-10%50V5K1200VIE CAPACITOR	CC 084.5350	UNION CARB	CK05BX104K	
C105	CC 10NF+-10%100V5K1200VIE CERAMIC CAPACITOR	CC 068.4060	UNION CARB	CK05BX103K	
C106	CC 1,5NF+-10%100V5K1200VI CERAMIC CAPACITOR	CC 060.2374	UNION CARB	CK05BX152K	
C107	CC 10NF+-10%100V5K1200VIE CERAMIC CAPACITOR	CC 068.4060	UNION CARB	CK05BX103K	
C109	CE 33 UF+-20%10V 7X 5X11 ELECTROLYTIC CAPACITOR	CE 087.0343	ROEDERSTEI	ETR 3 33/10 20%	
C110	CC 1NF+-10%200V5K1200VIEL CAPACITOR	CC 068.4047	UNION CARB	CK05BX102K	
C111	CK 10NF+-20%630V QUADER CAPACITOR	CK 024.7763	ROEDERST	MKT1822-310/6	
C112	CK 10NF+-20%630V QUADER CAPACITOR	CK 024.7763	ROEDERST	MKT1822-310/6	
C113	CC 10NF+-10%100V5K1200VIE CERAMIC CAPACITOR	CC 068.4060	UNION CARB	CK05BX103K	
C114	CC 10NF+-10%100V5K1200VIE CERAMIC CAPACITOR	CC 068.4060	UNION CARB	CK05BX103K	
C115	CC 10NF+-10%100V5K1200VIE CERAMIC CAPACITOR	CC 068.4060	UNION CARB	CK05BX103K	
C116	CC 10NF+-10%100V5K1200VIE CERAMIC CAPACITOR	CC 068.4060	UNION CARB	CK05BX103K	
C117	CK 220NF+-20%100V QUADER PLASTIC-FOIL CAPACITOR	CK 006.5056	ROEDERST	MKT1822-422/0	
C118	CC 100NF+-10%50V5K1200VIE CAPACITOR	CC 084.5350	UNION CARB	CK05BX104K	
C120	CC 820PF+- 5%100V NPD VIE CERAMIC CAPACITOR	060.0888	ERIE	8133-100COG-820PF	
C122	CC 3,9NF+- 5%100V NPD VIE CAPACITOR	060.0965	ERIE	8737-100-COG-3,9NF-J	
C123	CC 1,8NF+- 5%100V NPD VIE CAPACITOR	060.0920	ERIE	8133-100-COG-1,8NF-J	
C126	CC 1,2NF+- 5%100V NPD VIE CAPACITOR	060.0907	ERIE	8133-100-COG-1,2NF-J	

ROHDE & SCHWARZ	Äl	Datum Date	Schaltteilliste für Parts list for	Sachnummer Stock No.	Blatt Page
	34	0593	ED GRUNDPLATTE MAIN BOARD	647.0025.01 SA	2+

Für diese Unterlage behalten wir uns alle Rechte vor

Kennz. Comp.No.	Benennung Designation	Sachnummer Stock No.	Hersteller Manufacturer	Bezeichnung Designation	enthalten in contained in
C127	CC 1 NF+- 5%100V NPO VIEL CERAMIC CAPACITOR	060.0894	ERIE	8133-100-COG-1NF-J	
C129	CC 56PF+- 5%100V NPO VIEL CERAMIC CAPACITOR	CC 060.0742	UNIONCARB	CO52C560J2G1CA	
C130	CK 18NF+-1%63V7,50AX13 KP CAPACITOR	CK 099.1933	SIEMENS	B33531-A5183-F	
C131	CC 5,6NF+- 5%100V NPO VIE CAPACITOR	060.0988	ERIE	8737-100-COG-5,6NF-J	
C132	CK 12NF+-1%63V7,5QUX13 KP CAPACITOR	CK 340.6760	SIEMENS	B33531-A5123-F	
C133	CK 22NF+-1%63V8X8X11 KP CAPACITOR	CK 213.4553	SIEMENS	B33531-A5223-F	
C134	CK 12NF+-1%63V7,5QUX13 KP CAPACITOR	CK 340.6760	SIEMENS	B33531-A5123-F	
C138	CC 120PF+- 5%100V NPO VIE CERAMIC CAPACITOR	CC 060.0788	UNIONCARB	CO52C121J2G1CA	
C139	CC 22PF+- 5%100V NPO VIEL CERAMIC CAPACITOR	CC 060.0694	UNIONCARB	CO52C220J2G1CA	
C140	CC 100PF+- 5%100V NPO VIE CERAMIC CAPACITOR	CC 060.0771	UNIONCARB	CO52C101J2G1CA	
C141	CC 56PF+- 5%100V NPO VIEL CERAMIC CAPACITOR	CC 060.0742	UNIONCARB	CO52C560J2G1CA	
C142	CC 39PF+- 5%100V NPO VIEL CERAMIC CAPACITOR	CC 060.0720	UNIONCARB	CO52C390J2G1CA	
C143	CC 22PF+- 5%100V NPO VIEL CERAMIC CAPACITOR	CC 060.0694	UNIONCARB	CO52C220J2G1CA	
C144	CC 12PF+- 5%100V NPO VIEL CERAMIC CAPACITOR	CC 060.0665	UNIONCARB	CO52C120J2G1CA	
C145	CC 47PF+- 5%100V NPO VIEL CERAMIC CAPACITOR	CC 060.0736	UNIONCARB	CO52C470J2G1CA	
C149	CC 100NF+-10%50V5K1200VIE CAPACITOR	CC 084.5350	UNION CARB	CK05BX104K	
C157	CC 100NF+-10%50V5K1200VIE CAPACITOR	CC 084.5350	UNION CARB	CK05BX104K	
C158	CC 100NF+-10%50V5K1200VIE CAPACITOR	CC 084.5350	UNION CARB	CK05BX104K	
C159	CC 100NF+-10%50V5K1200VIE CAPACITOR	CC 084.5350	UNION CARB	CK05BX104K	
C160	CC 100NF+-10%50V5K1200VIE CAPACITOR	CC 084.5350	UNION CARB	CK05BX104K	
C161 ..169	CC 100NF+-10%50V5K1200VIE CAPACITOR	CC 084.5350	UNION CARB	CK05BX104K	
C170	CC 100NF+-10%50V5K1200VIE CAPACITOR	CC 084.5350	UNION CARB	CK05BX104K	
C171 ..179	CC 100NF+-10%50V5K1200VIE CAPACITOR	CC 084.5350	UNION CARB	CK05BX104K	
C200	CC 22PF+-2%4X5NPO CAPACITOR	CC 087.6464	PHILIPS-CO	2222 678 10229	
C201	CK 10NF+-5%63V RD2,5H7MKT CAPACITOR	CK 099.2869	WIMA	MKS2	
D1	BL CD4013BF 2XD FLIPFL FLIPFLOP	086.8034	RCA	CD4013BF	
D2	BL CD40174BF 6XD- FLIPFL FLIPFLOP	092.9474	RCA	CD40174BF	
D3	BL CD4013BF 2XD FLIPFL FLIPFLOP	086.8034	RCA	CD4013BF	
D4	BL CD40174BF 6XD- FLIPFL FLIPFLOP	092.9474	RCA	CD40174BF	
D5	BL SCL4028BC BCD/DEC.DEC BCD/DECADE DECODER	290.1178	MOTOROLA	MC14028BAL	
D6 ..8	BL MM54C906J 6XN-CH.BUFF N-CHANNEL BUFFER OD	418.0264	NSC	MM54C906J	
H1	SU RD9,7X6 M.DRAHTANSCHL. SPARK-GAP VOLTAGE DISCHAR	SU 210.6161	SIEMENS	Q69-X152	
K1 ..9	SN RELAIS 16V 1300 OHM RELAY	469.6676	SDS	RELAIS RH-16V	
K20	SN RELAIS 16V 1300 OHM RELAY	469.6676	SDS	RELAIS RH-16V	
K21	SN RELAIS 16V 1300 OHM RELAY	469.6676	SDS	RELAIS RH-16V	
K22 ..30	SN RELAIS 16V 1300 OHM RELAY	469.6676	SDS	RELAIS RH-16V	
K31	SN GEPOLT 2XU 12V RELAY	645.6810	SDS	DS2E-DC12V	

ROHDE & SCHWARZ	Äi	Datum Date	Schaltteilliste für Parts list for	Sachnummer Stock No.	Blatt Page
	34	0593	ED GRUNDPLATTE MAIN BOARD	647.0025.01 SA	3+

Kennz. Comp.No.	Benennung Designation	Sachnummer Stock No.	Hersteller Manufacturer	Bezeichnung Designation	enthalten in contained in
K32	SN RELAIS 16V 1300 OHM RELAY	469.6676	SDS	RELAIS RH-16V	
K33	SN RELAIS 16V 1300 OHM RELAY	469.6676	SDS	RELAIS RH-16V	
K35	SN GEPOLT 2XU 12V RELAY	645.6810	SDS	DS2E-DC12V	
K36	SN GEPOLT 2XU 12V RELAY	645.6810	SDS	DS2E-DC12V	
K38	SR 5V3600HM1MAL1RH-JC-GEH RELAY	SR 412.0027	SIEMENS	V23100-V4005-A000	
K39	SR 5V3600HM1MAL1RH-JC-GEH RELAY	SR 412.0027	SIEMENS	V23100-V4005-A000	
K41 ..46	SR 5V3600HM1MAL1RH-JC-GEH RELAY	SR 412.0027	SIEMENS	V23100-V4005-A000	
K48	SR 5V3600HM1MAL1RH-JC-GEH RELAY	SR 412.0027	SIEMENS	V23100-V4005-A000	
K49	SR 5V3600HM1MAL1RH-JC-GEH RELAY	SR 412.0027	SIEMENS	V23100-V4005-A000	
K50	SN GEPOLT 2XU 12V RELAY	645.6810	SDS	DS2E-DC12V	
L11	LD 680 UH10%60,00HMO,030A CHOKE	LD 067.3201	DELEVAN	DROSSEL 1025-88	
L14	LD 1,8UH 2% 0,6A OR74 COIL	LD 283.2408	JAHRE	74.11-1R80G	
L15	LD 3,9UH 2% 1,25A OR155 HF-COIL	645.7439	JAHRE	74.11-3R90 TOL.+2%	
L16	LD 56UH 2% 0,335A 2R3 HF-COIL	645.7445	JAHRE	74.11-56R0 TOL.+2%	
L17	LD 27UH 2% 0,3A 2R75 CHOKE	LD 567.3987	JAHRE	74.11-27ROG	
L18	LD 220NH 2% 2A ORO35 CHOKE	LD 523.7770	JAHRE	74.11-R220G	
L19	LD 330NH 2% 2A ORO65 CHOKE	LD 567.4019	JAHRE	74.11-R330G	
L20	LD 150NH 2% 3,0A ORO3 CHOKE	LD 567.4002	JAHRE	74.11-R150G	
L21	LD 1,20UH10%0,180HMO,620A CHOKE	LD 067.2870	DELEVAN	DROSSEL 1025-22	
L22	LD 100 UH10%8,000HMO,084A CHOKE	LD 067.3101	DELEVAN	DROSSEL 1025-68	
L23	LD 100 UH10%8,000HMO,084A CHOKE	LD 067.3101	DELEVAN	DROSSEL 1025-68	
L24	LD 100 UH10%8,000HMO,084A CHOKE	LD 067.3101	DELEVAN	DROSSEL 1025-68	
L25 ..28	LD 150UH BEI 0,17A 6,20HM CHOKE	LD 026.4055	JAHRE	72.10-1500K	
L30	LD SPULE COIL	647.0831			
N1	BO MC1558JG 2X OPAMP OPERATIONAL AMPLIFIER	275.0816	NSC	LM1558J	
N2	BO SL610CCM8 IF AMPL IF AMPLIFIER	610.4110	PLESSEY	SL610CCM8	
N3	BO TCA965 FENSTER-DISKR DISCRIMINATOR	BO 279.2213	SIEMENS	TCA965A	
N4	BO TCA965 FENSTER-DISKR DISCRIMINATOR	BO 279.2213	SIEMENS	TCA965A	
R1 ..12	RL 0,60W 4,75KOHM+-1%TK50 RESISTOR	RL 083.1097	DRALORIC	SMA0207/4,75K-F-D	
R13	RL 0,60W 47,5 OHM+-1%TK50 RESISTOR	RL 082.9507	DRALORIC	SMA0207/47,5OHM-F-D	
R15	RL 0,60W 221 OHM+-1%TK50 RESISTOR	RL 083.0084	DRALORIC	SMA0207/221OHM-F-D	
R16	RL 0,60W 1KOHM+-1%TK50 RESISTOR	RL 082.2160	DRALORIC	SMA0207/1K-F-C	
R17	RD 0,8W 150 OHM+-1% WIRE WOUND RESISTOR	RD 087.5345	SAGE	1000S1500HM+1%	
R21 ..32	RL 0,60W 10,0KOHM+-1%TK50 RESISTOR	RL 083.1297	DRALORIC	SMA0207/10K-F-D	
R41 ..52	RL 0,60W 1KOHM+-1%TK50 RESISTOR	RL 082.2160	DRALORIC	SMA0207/1K-F-C	
R53	RL 0,60W 1KOHM+-1%TK50 RESISTOR	RL 082.2160	DRALORIC	SMA0207/1K-F-C	
R55	RL 0,60W 100 OHM+-1%TK50 RESISTOR	RL 082.6543	DRALORIC	SMA0207/100/HM-F-D	

ROHDE & SCHWARZ	Äl	Datum Date	Schaltteilliste für Parts list for	Sachnummer Stock No.	Blatt Page
	34	0593	ED GRUNDPLATTE MAIN BOARD	647.0025.01 SA	4+

Kennz. Comp.No.	Benennung Designation	Sachnummer Stock No.	Hersteller Manufacturer	Bezeichnung Designation	enthalten in contained in
R61 . .66	RL 0,60W 10,0KOHM+-1%TK50 RESISTOR	RL 083.1297	DRALORIC	SMA0207/10K-F-D	
R68	RL 0,60W 10,0KOHM+-1%TK50 RESISTOR	RL 083.1297	DRALORIC	SMA0207/10K-F-D	
R69	RL 0,60W 10,0KOHM+-1%TK50 RESISTOR	RL 083.1297	DRALORIC	SMA0207/10K-F-D	
R71 . .76	RL 0,60W 10,0KOHM+-1%TK50 RESISTOR	RL 083.1297	DRALORIC	SMA0207/10K-F-D	
R78	RL 0,60W 10,0KOHM+-1%TK50 RESISTOR	RL 083.1297	DRALORIC	SMA0207/10K-F-D	
R79	RL 0,60W 10,0KOHM+-1%TK50 RESISTOR	RL 083.1297	DRALORIC	SMA0207/10K-F-D	
R80	RS 0,5W1KOHM+-10%10X10X5 CERMET POTENTIOMETER T	RS 087.7560	BOURNS	3386F-1-102	
R81	RL 0,60W 475 OHM+-1%TK50 RESISTOR	RL 083.0390	DRALORIC	SMA0207/475OHM-F-D	
R82	RL 0,60W 56,2 OHM+-1%TK50 RESISTOR	RL 082.9571	DRALORIC	SMA0207/56,20HM-F-D	
R83	RL 0,60W 221 OHM+-1%TK50 RESISTOR	RL 083.0084	DRALORIC	SMA0207/221OHM-F-D	
R84	RL 0,60W 47,5 OHM+-1%TK50 RESISTOR	RL 082.9507	DRALORIC	SMA0207/47,50HM-F-D	
R85	RL 0,60W 10,0KOHM+-1%TK50 RESISTOR	RL 083.1297	DRALORIC	SMA0207/10K-F-D	
R86	RL 0,60W 1KOHM+-1%TK50 RESISTOR	RL 082.2160	DRALORIC	SMA0207/1K-F-C	
R87	RL 0,60W 10,0KOHM+-1%TK50 RESISTOR	RL 083.1297	DRALORIC	SMA0207/10K-F-D	
R89	RL 0,60W 10,0KOHM+-1%TK50 RESISTOR	RL 083.1297	DRALORIC	SMA0207/10K-F-D	
R90	RL 0,60W12,10 OHM+-1%TK50 RESISTOR	RL 082.8930	DRALORIC	SMA0207/12,10HM-F-D	
R91	RL 0,60W 10,0KOHM+-1%TK50 RESISTOR	RL 083.1297	DRALORIC	SMA0207/10K-F-D	
R92	RL 0,60W3,92 OHM+-1%TK50 METALFILMRESISTOR	RL 099.8009	RESISTA	MK2 3,92 OHM 1% TK50	
R93	RL 0,60W 10,0KOHM+-1%TK50 RESISTOR	RL 083.1297	DRALORIC	SMA0207/10K-F-D	
R94	RL 0,60W 100KOHM+-1%TK50 RESISTOR	RL 082.1764	DRALORIC	SMA0207/100K-F-C	
R96	RL 0,60W 10,0KOHM+-1%TK50 RESISTOR	RL 083.1297	DRALORIC	SMA0207/10K-F-D	
R97	RL 0,60W 100KOHM+-1%TK50 RESISTOR	RL 082.1764	DRALORIC	SMA0207/100K-F-C	
R98	RL 0,60W 1KOHM+-1%TK50 RESISTOR	RL 082.2160	DRALORIC	SMA0207/1K-F-C	
R99	RL 0,60W 10,0KOHM+-1%TK50 RESISTOR	RL 083.1297	DRALORIC	SMA0207/10K-F-D	
R100	RS 0,5W1KOHM+-10%10X10X5 CERMET POTENTIOMETER T	RS 247.7903	BOURNS	3386F-1-103	
R101	RL 0,60W 10,0KOHM+-1%TK50 RESISTOR	RL 083.1297	DRALORIC	SMA0207/10K-F-D	
R102	RL 0,60W 4,75KOHM+-1%TK50 RESISTOR	RL 083.1097	DRALORIC	SMA0207/4,75K-F-D	
R103	RL 0,60W 4,75KOHM+-1%TK50 RESISTOR	RL 083.1097	DRALORIC	SMA0207/4,75K-F-D	
R104	RL 0,60W 4,75KOHM+-1%TK50 RESISTOR	RL 083.1097	DRALORIC	SMA0207/4,75K-F-D	
R108	RL 0,60W 1MOHM+-1%TK50 RESISTOR	RL 082.7862	DRALORIC	SMA0207/1M-F-D	
R109	RL 0,60W 1MOHM+-1%TK50 RESISTOR	RL 082.7862	DRALORIC	SMA0207/1M-F-D	
R110	RF 0,5W 330 OHM+-5% DEPOS.-CARBON RESISTOR	007.1319	RESISTA	SK4/330OHM5%	
R111	RL 0,60W 1MOHM+-1%TK50 RESISTOR	RL 082.7862	DRALORIC	SMA0207/1M-F-D	
R112	RL 0,60W 1MOHM+-1%TK50 RESISTOR	RL 082.7862	DRALORIC	SMA0207/1M-F-D	
R113	RL 0,60W 562 KOHM+-1%TK50 RESISTOR	RL 083.2664	DRALORIC	SMA0207/562K-F-C	
R114	RL 0,60W 1MOHM+-1%TK50 RESISTOR	RL 082.7862	DRALORIC	SMA0207/1M-F-D	
R115	RL 0,60W 2.74MOHM+-1%TK50 METALFILMRESISTOR	RL 099.8980	RESISTA	MK2 2.74MOHM+-1%TK50	
R116	RL 0,60W 121KOHM+-1%TK50 RESISTOR	RL 083.2070	DRALORIC	SMA/207/121K-F-C	
R117	RL 0,60W 15,0KOHM+-1%TK50 RESISTOR	RL 083.1400	DRALORIC	SMA0207/15K-F-D	

ROHDE & SCHWARZÄl Datum
Date**34 0593**Schaltteilliste für
Parts list for**ED GRUNDPLATTE
MAIN BOARD**Sachnummer
Stock No.**647.0025.01 SA**Blatt
Page**5+**

Kennz. Comp.No.	Benennung Designation	Sachnummer Stock No.	Hersteller Manufacturer	Bezeichnung Designation	enthalten in contained in
R118	RL 0,60W 68,1KOHM+-1%TK50 RESISTOR	RL 082.2602	DRALORIC	SMA 0207/68,1K-F-C	
R119	RL 0,60W 100KOHM+-1%TK50 RESISTOR	RL 082.1764	DRALORIC	SMA0207/100K-F-C	
R120	RL 0,60W 1KOHM+-1%TK50 RESISTOR	RL 082.2160	DRALORIC	SMA0207/1K-F-C	
R121	RL 0,40W 10,0 OHM+-1%TK50 RESISTOR	RL 092.1715	RESISTA	MK1 10,0OHM 1% TK50	
R122	RL 0,60W 562 KOHM+-1%TK50 RESISTOR	RL 083.2664	DRALORIC	SMA0207/562K-F-C	
R123	RD 10W 2,7KOHM+-3%IND.ARM WIRE WOUND RESISTOR	645.7416	DALE	NH-10 2,7KOHM 3%	
R124	RL 0,60W 56,2 OHM+-1%TK50 RESISTOR	RL 082.9571	DRALORIC	SMA0207/56,2OHM-F-D	
R125	RL 0,60W 56,2 OHM+-1%TK50 RESISTOR	RL 082.9571	DRALORIC	SMA0207/56,2OHM-F-D	
R126	RL 0,60W 10,0KOHM+-1%TK50 RESISTOR	RL 083.1297	DRALORIC	SMA0207/10K-F-D	
R127	RL 0,60W 10,0KOHM+-1%TK50 RESISTOR	RL 083.1297	DRALORIC	SMA0207/10K-F-D	
R128	RL 0,60W 10,0 OHM+-1%TK50 RESISTOR	RL 082.8852	DRALORIC	SMA0207/100OHM-F-D	
R129	RL 0-OHM-WIDERST. 0204 O-OHM RESISTOR	RL 069.0000	DRALORIC	OMA 0204	
R130	RL 0,60W27,40 OHM+-1%TK50 RESISTOR	RL 082.9271	DRALORIC	SMA0207/27,40OHM-F-D	
R131	RL 0,60W 33,2 OHM+-1%TK50 RESISTOR	RL 082.9359	DRALORIC	SMA0207/33,2OHM-F-D	
R132	RL 0,60W27,40 OHM+-1%TK50 RESISTOR	RL 082.9271	DRALORIC	SMA0207/27,40OHM-F-D	
R133	RL 0,60W 33,2 OHM+-1%TK50 RESISTOR	RL 082.9359	DRALORIC	SMA0207/33,2OHM-F-D	
T1	LU UEBERTRAGER TRANSFORMER	647.0825			
V1 ..12	AK BCY59IX N 45V 200MA TRANSISTOR	AK 010.5163	PHILIPS-CO	BCY59IX	
V13 ..18	AK BCY79IX P 45V 200MA TRANSISTOR	AK 010.3777	PHILIPS-CO	BCY79IX	
V19	AK BCY59IX N 45V 200MA TRANSISTOR	AK 010.5163	PHILIPS-CO	BCY59IX	
V20	AK BCY79IX P 45V 200MA TRANSISTOR	AK 010.3777	PHILIPS-CO	BCY79IX	
V21	AK BCY79IX P 45V 200MA TRANSISTOR	AK 010.3777	PHILIPS-CO	BCY79IX	
V22	AD 1N4448 75V UDI DIODE	AD 012.0700	TEXAS INST	1N4448 GEGURTET	
V25	AK 2N2219A N 40V 800MA TRANSISTOR	AK 083.6953	PHILIPS-CO	2N2219A	
V26	AD BAV10 60V UDI DIODE	AD 012.9437	PHILIPS-CO	BAV10	
V27	AE BZX55/B27 0,5W ZDI ZENER DIODE	AE 615.9085	PHILIPS-CO	BZX55/B27	
V31 ..48	AD 1N4448 75V UDI DIODE	AD 012.0700	TEXAS INST	1N4448 GEGURTET	
V50	AD 1N4448 75V UDI DIODE	AD 012.0700	TEXAS INST	1N4448 GEGURTET	
V51	AD 1N4448 75V UDI DIODE	AD 012.0700	TEXAS INST	1N4448 GEGURTET	
V52	AD 1N4448 75V UDI DIODE	AD 012.0700	TEXAS INST	1N4448 GEGURTET	
V55 ..58	AE 5082-2800 SCHOTTKY DIODE	AE 012.9066	HEWLETT-P.	5082-2800	
V60	AE DSB6419-55 100V PIN PIN DIODE	645.7345	ALPHA IND	DSB6419-55	
V61	AE DSB6419-55 100V PIN PIN DIODE	645.7345	ALPHA IND	DSB6419-55	
V62	AK BC517 N 30V DARL TRANSISTOR	AK 282.2133	SIEMENS	BC517	
V64	AE BZX55/B5V1 0,5W ZDI ZENER DIODE	AE 262.5837	PHILIPS-CO	BZX55/B5V1	
V65	AD BAV21 250V UDI DIODE	AD 082.6837	INTERMETAL	BAV21	
V66	AD BAV21 250V UDI DIODE	AD 082.6837	INTERMETAL	BAV21	
V67	AE BZX55/B8V2 0,5W ZDI ZENER DIODE	AE 012.2178	PHILIPS-CO	BZX55/B8V2	

ROHDE & SCHWARZ	ÄI	Datum Date	Schaltteilliste für Parts list for	Sachnummer Stock No.	Blatt Page
	34	0593	ED GRUNDPLATTE MAIN BOARD	647.0025.01 SA	6+

Kennz. Comp.No.	Benennung Designation	Sachnummer Stock No.	Hersteller Manufacturer	Bezeichnung Designation	enthalten in contained in
V68 ..71	AD 1N4448 75V UDI DIODE	AD 012.0700	TEXAS INST	1N4448 GEGURTET	
V72 ..75	AD BAV10 60V UDI DIODE	AD 012.9437	PHILIPS-CO	BAV10	
V76	AE BZT03/C16 3.2W ZDI ZENER DIODE	AE 007.4201	PHILIPS-CO	BZT03/C16	
V77	AD BAV21 250V UDI DIODE	AD 082.6837	INTERMETAL	BAV21	
V78	AD BAV21 250V UDI DIODE	AD 082.6837	INTERMETAL	BAV21	
V80	AD FDH300 125V 0A50 UDI DIODE NUR VAR/ONLY MOD: 03	AD 012.1442	FAIRCHILD	FDH300	
W1	DW KABEL CABLE	647.0848			647.0460
W2	DW KABEL CABLE	647.0854			647.0460
W3	DW KABEL CABLE	647.0860			647.0460
W4	DW KABEL CABLE	647.0877			647.0460
W5	DW KABEL CABLE	647.0883			647.0460
W6	DW KABEL CABLE	647.0890			647.0460
W7	DW KABEL CABLE	647.0902			647.0460
W8	DW KABEL CABLE	647.0919			647.0460
W10	DW KABEL	647.0925			647.0460
X1	FP STIFTLAISTE 36P.R2,54 PIN CONNECTOR 4-POLIG	FP 242.3600	BINDER	742-11-0179-00-36	
X4	FP STIFTLAISTE 36P.R2,54 PIN CONNECTOR 3-POLIG	FP 242.3600	BINDER	742-11-0179-00-36	
X5	FP STIFTLAISTE 36P.R2,54 PIN CONNECTOR 3-POLIG	FP 242.3600	BINDER	742-11-0179-00-36	
X6	FP STECKERLAISTE 10P.GER CONNECTOR 10POL.	FP 649.4428	SIEMENS	V23535-A1200-A100	
X7	FP STIFTLAISTE 36P.R2,54 PIN CONNECTOR 5-POLIG	FP 278.5477	BERG	75160-...-36	
X8	FP STIFTLAISTE 36P.R2,54 PIN CONNECTOR 3-POLIG	FP 242.3600	BINDER	742-11-0179-00-36	
X11	FP KURZSCHLUSSBUCHSE SHORTING PLUG	FP 491.7042	PK	452-70302	
X18	FP KURZSCHLUSSBUCHSE SHORTING PLUG	FP 491.7042	PK	452-70302	
X51	FP STECKERLAISTE 32POL. MULTIPOINT CONNECTOR	FP 514.4550	ERNI	533.408	
X52 ..56	FJ EINBAUSTECKER SYST.SMB FIXED CONNECTOR	FJ 063.5116	SUHNER	22SMB-50-0-2 ZU 100	
					- ENDE -

ROHDE & SCHWARZ

Äl Datum
Date

34 0593

Schaltteilliste für
Parts list for

ED GRUNDPLATTE
MAIN BOARD

Sachnummer
Stock No.

647.0025.01 SA

Blatt
Page

7-



R. SCHWARZ

ÄZ Datum
Date
05 1185

Schaltteilliste für
Parts list for
ED LC-PLATTE
LC BOARD

Sachnummer
Stock No.
647.0054.01 SA

Blatt
Page
1

Kennzeichen Component No.	Benennung/Beschreibung Designation	Sachnummer Stock No.	enthalten in contained in
.	VARIANTENERKL. / VERSIONS VAR 02 = GRUNDAUSFUEHRUNG MOD 02 = BASIC MODEL		
C51	CG 33 PF+-1PF 250V TK+100 MICA CAPACITOR JAHRE 53.03 33PF+-1PF 250V	CG 006.9274	
C52	CG 47 PF+-1PF 250V TK+100 MICA CAPACITOR JAHRE 53.03 47PF+-1PF 250V	CG 006.9297	
C53	CG 33 PF+-1PF 250V TK+100 MICA CAPACITOR JAHRE 53.03 33PF+-1PF 250V	CG 006.9274	
C54	CG 56 PF+-1PF 250V TK+100 MICA CAPACITOR JAHRE 53.03 56PF+-1PF 250V	CG 006.9300	
C55	CG 100PF+-1PF 250V TK+100 MICA CAPACITOR JAHRE 53.03 100PF+-1PF 250V	CG 006.9339	
C56	CG 120PF+-1% 250V TK+100 MICA CAPACITOR JAHRE 53.03 120PF+-1% 250V	CG 006.9345	
C57	CG 100PF+-1PF 250V TK+100 MICA CAPACITOR JAHRE 53.03 100PF+-1PF 250V	CG 006.9339	
C58	CG 150PF+-1% 250V TK+100 MICA CAPACITOR JAHRE 53.03 150PF+-1% 250V	CG 006.9351	
C59	CG 180PF+-1% 250V TK+100 MICA CAPACITOR JAHRE 53.03 180PF+-1% 250V	CG 006.9368	
C63	CG 12 PF+-1PF 250V TK+100 MICA CAPACITOR JAHRE 53.03 12PF+-1PF 250V	CG 006.9222	
C65	CG 10 PF+-1PF 250V TK+100 MICA CAPACITOR JAHRE 53.03 10PF+-1PF 250V	CG 006.9216	
C67	CG 12 PF+-1PF 250V TK+100 MICA CAPACITOR JAHRE 53.03 12PF+-1PF 250V	CG 006.9222	
C68	CG 10 PF+-1PF 250V TK+100 MICA CAPACITOR JAHRE 53.03 10PF+-1PF 250V	CG 006.9216	
C69	CG 27 PF+-1PF 250V TK+100 MICA CAPACITOR JAHRE 53.03 27PF+-1PF 250V	CG 006.9268	
C180	CE 47UF -10+100%40V 11X13 ELECTROLYTIC CAPACITOR SIEMENS B41316-37476-Z	022.7589	
C181	CT 20,8PFNORMAL 0/U 4ST AIR-TYPE TRIMMER TRONSER LUFTTR10111120020000	CT 025.7221	
BIS/TO C189			

Für dieses Unterlage behalten wir
uns alle Rechte vor

 ROHDE & SCHWARZ	ÄZ	Datum	Schaltteilliste für	Sachnummer	Blatt Page
	05	1185	Parts list for ED LC-PLATTE LC BOARD	Stock No. 647.0054.01 SA	

Kennzeichen Component No.	Benennung/Beschreibung Designation	Sachnummer Stock No.	enthalten in contained in
C190	CC 100NF+-10%50V5K1200VIE CAPACITOR UNION CARB M39014/01-1433	CC 084.5350	
C191	CC 100NF+-10%50V5K1200VIE CAPACITOR UNION CARB M39014/01-1433	CC 084.5350	
C192	CC 100NF+-10%50V5K1200VIE CAPACITOR UNION CARB M39014/01-1433	CC 084.5350	
BIS/TO C196 C197	CC 100NF+-10%50V5K1200VIE CAPACITOR UNION CARB M39014/01-1433	CC 084.5350	
C198	CC 100NF+-10%50V5K1200VIE CAPACITOR UNION CARB M39014/01-1433	CC 084.5350	
C199	CC 100NF+-10%50V5K1200VIE CAPACITOR UNION CARB M39014/01-1433	CC 084.5350	
K11	SN GEPOLT 2XU 12V RELAY SDS DS2E-DC12V	645.6810	
BIS/TO K19			
L1	LD SPULE COIL	647.0725	
L2	LD SPULE COIL	647.0731	
L3	LD SPULE COIL	647.0748	
L4	LD SPULE COIL	647.0754	
L5	LD SPULE COIL	647.0760	
L6	LD SPULE COIL	647.0777	
L7	LD SPULE COIL	647.0783	
L8	LL SPULE COIL	647.0790	
L9	LL SPULE COIL	647.0802	
W9	DX FLACHLEITUNG RIBBON CABLE	647.0719	
X17	FP BUCHSE VERTIKAL P.V.1P SOCKET BERG 75377-001 3-POLIG	FP 278.5577	

- ENDE -



ROHDE & SCHWARZ

Communications Division

Repair Manual

MOTOR - TUNED FILTER

FK 852P4

647.2011

©

Copying of this document as well as any other utilization and communication of its content are only admissible with the permission of the originator or other authorized persons.

Any disregard will be prosecuted and is subject to restitution (UrhG, UWG, BGB). For the case a patent is issued or the design is officially registered all rights are reserved.

ROHDE & SCHWARZ GmbH & Co. KG · D-81671 München · Mühldorfstr. 15 · Tel. (089) 4129-0 Int. + 4989 4129-0

Telefax (089) 4129-2164 Int. + 4989 4129-2164

**Printed in the Federal Republic of Germany · Subject to change · Data without tolerances : order of magnitude only
0694**

MOTOR-TUNED FILTER
FK 852P4

Repair Manual
Part 0: List of Contents

- 0.1 -

LIST OF CONTENTS

	Page
1. Characteristics (see User Manual) .	1.1
2. Preparation for Use and Operation (see User Manual) .	2.1
3. Maintenance (see User Manual) .	3.1
4. Troubleshooting (see User Manual) .	4.1
5. Description of Function	5.1
5.1 HF Circuit	5.1
5.1.1 Received-signal Path	5.1
5.1.2 Transmitted-signal Path	5.2
5.1.3 Test-signal Path	5.2
5.2 Control Circuit	5.2
5.2.1 General	5.2
5.2.2 Motor Control Circuit	5.3
5.2.3 Relay Control Circuit	5.4
6. Repair	6.1
6.1 Preliminary Remarks	6.1
6.1.1 Troubleshooting Instructions	6.1
6.1.2 Restoring the Nominal Characteristics	6.1
6.1.3 Spare Parts	6.1
6.1.4 Important User Information	6.2
6.2 Test Equipment	6.2
6.2.1 List of Test Equipment	6.3

(Continuation)---

MOTOR-TUNED FILTER
FK 852P4

Repair Manual
 Part 0: List of Contents

- 0.2 -

---(Continuation) List of Contents

6.3	Troubleshooting Flowchart	6.4
6.3.1	General	6.4
6.4	Measurements, Alignments and Functional Checks	6.16
6.4.1	Checking the Motor-tuned Filter	6.16
6.4.2	Checking the Motor Control Circuit	6.17
6.4.3	Checking the Light Barrier Control Circuit	6.17
6.4.4	Checking the Relay Control Circuit	6.18
6.4.5	Checking the Selectivity	6.19
6.4.6	Checking the Gain	6.20
6.4.7	Alignment of the HF Circuit	6.20
6.4.8	Alignment of the 1-MHz Low-pass Filter	6.21
6.4.9	Checking the Overload Switch-off Circuit	6.22
6.4.10	Checking the BITE signal	6.22
6.5	Replacment of Subassemblies and Components	6.22
6.5.1	Removal of Subassemblies	6.22
6.5.1.1	Variable Capacitor and Gearbox	6.22
6.5.1.2	Stepping Motor	6.23
6.5.1.3	Control Circuit	6.23
6.5.1.4	HF Circuit	6.23
6.5.2	Reinstallation of Subassemblies	6.24
6.5.2.1	Stepping Motor	6.24
6.5.2.2	Variable Capacitor and Gearbox	6.24
6.5.3	Replacing Components	6.24
6.6	Final Inspection	6.24
6.6.1	Checking Intermodulation Distance in Transmission	6.25
6.6.2	Checking the Intermodulation Distance in Reception	6.25
6.6.3	Checking the Noise Figure	6.26
6.7	External Interfaces	6.27

(Continuation)---

MOTOR-TUNED FILTER
FK 852P4

Repair Manual

Part 0: List of Contents

- 0.3 -

---(Continuation) List of Contents

LIST OF FIGURES

Fig.	Title	Page
5.1	Block Diagram	5.5
6.1	Troubleshooting Flowchart	6.5
6.2	Motor Control Circuit, Troubleshooting Flowchart	6.6
6.3	Light Barrier Control Circuit, Troubleshooting Flowchart	6.9
6.4	Relay Control Circuit, Troubleshooting Flowchart	6.11
6.5	HF Circuit, Troubleshooting Flowchart	6.14
6.6	Removal of Subassemblies	6.29
6.7	Preadjustment of the Tuning Range	6.31
6.8	Gearbox	6.31
6.9	Mechanical Stop	6.33
6.10	Control Disk 1	6.33
6.11	Control Disk 2	6.33
6.12	Mechanical Final Stop	6.35
6.13	Test Set-up for measuring Pass-band	6.37
6.14	Test Set-up for measuring Selectivity	6.37
6.15	Test Set-up for Checking the Gain, the HF Circuit and the 1-MHz Low-pass Filter	6.39
6.16	Test Set-up for measuring Overload Switch-off	6.39
6.17	Test Set-up for Test of the BITE Signal	6.41
6.18	Test Set-up for measuring Intermodulation Distance	6.41
6.19	Test Set-up for measuring Noise Figure	6.43

Appendix *****

Circuit Diagram	Motor-tuned Filter	647.2011.01S
Parts List	Motor-tuned Filter	647.2011.01SA
Parts List	Variable Capacitor + Gear	647.2192.00SA
Circuit Diagram	HF Circuit	647.2411.01S
Parts List	HF Circuit	647.2411.01SA
Component Layout	HF Circuit	647.2411.01, sh.2
Circuit Diagram	Control Circuit	647.5310.01S, sh.1 to 3
Parts List	Control Circuit	647.5310.01SA
Component Layout	Control Circuit	647.5310.01, sh. 2

MOTOR-TUNED FILTER
FK 852P4

Repair Manual
Part 0: List of Contents

NOTES

MOTOR-TUNED FILTER
FK 852P4

Repair Manual

Part 5: Description of Function

- 5.1 -

5. Description of Function

(see circuit diagrams 647.2411.01S and 647.5310.01S)

5.1 HF Circuit

5.1.1 Received-signal Path

The received signal is fed into the Motor-tuned Filter FK 852P4 via plug X52 in the control circuit. Via relay K7 it is fed to the low-pass filter consisting of inductors L1, L2 and of capacitors C64 and C52. Controlled by relay K5 the signal leaves the control circuit via plug X11 resp. X12. The signal-path switching is frequency-dependent. For receive signals below 1 MHz the signal is applied to X11. For receive signals in the range of 1 to 30 MHz the signal is applied to plug X12. An audio transformer L3 is looped into the signal path to monitor the current of the antenna signal. For that purpose a voltage proportional to the antenna signal current is generated by winding 3-4 and resistor R148. This voltage is then rectified by diode V51 and fed to comparator N11.1.

For monitoring purposes the capacitive voltage divider C66 and C65 is coupling out a portion of the antenna signal voltage. This portion is rectified by diodes V52/V50 and then fed to the comparator N11.1. When the antenna signal current exceeds approx. 0.5 A or when the antenna signal voltage rises above 30 V, the antenna is automatically switched to ground for about 2 seconds. This is accomplished by the comparator N11.1 and the subsequent control circuit, consisting of monoflop D12, buffer D5.5 via triggering transistor N9 (12, 13 14) of relay K7. The switch-off time is determined by the R/C circuit R100 and C32. After 2 seconds a new comparison for overload detection is initialized.

With reception frequencies of less than 1 MHz, the signal is fed from plug X11 and socket X11 of the HF circuit, via the low-pass filter, consisting of coils L3, L4 and of capacitors C74 to C77 to the relay K6. From there it is fed via plug X55 to the Tx/Rx Section GX 852P4.

In order to protect the Tx/Rx section against extraneous noise signals in the pass-band of the low-pass filter ($f < 1$ MHz) there is a limiter circuit looped in, consisting of diodes V8 to V10. The limiter is activated by noise signals exceeding the V8 Zener voltage of 3.9 V. Due to the bias voltage of the Zener diode V8 intermodulation and noise results for signal voltages up to 2 V EMF are avoided.

With reception frequencies in the range of 1 to 30 MHz one of the five sub-ranges is switched on by relays K11 to K13 and K51 to K53. Cascading of the sub-ranges is performed in octave distance, i.e. the frequency range is doubled each time (1 to 2 MHz, 2 to 4 MHz up to 16 to 30 MHz).

The further explanation of the received-signal path is for sub-range 5 (16 to 30 MHz). However the remaining sub-ranges 1 to 4 function in a similar manner.

The reception signal is fed-in via relay K51 (9, 13) and then it is inductively coupled into the first oscillator L51. Tuning and coupling of the oscillators is performed by the 5-way variable capacitor C100. Next the re-

(Continuation)---

MOTOR-TUNED FILTER
FK 852P4

Repair Manual
 Part 5: Description of Function

- 5.2 -

---(Continuation) Received-signal Path

ception signal is inductively coupled out by the third resonator L53 and fed via relay K53 (9,13) and K4 (13, 11) to the noise and distortion-free amplifier stage V12. In this amplifier stage input attenuation of the filter is compensated for. The amplified signal is then fed via relay K6 and plug X55 to the Tx/Rx Section GX 852P1.

At the upper point of the first oscillator, connection 1 of the variable capacitor, an overvoltage discharge device H1 is connected. It ignites at a voltage of approx. 90 V and so prevents destruction of the first oscillator due to too high overvoltages. At ignition of H1 the flowing current causes a voltage on resistor R12. This voltage is rectified by diodes V1 and V2, filtered by capacitor C71 and fed via plug X10.1 to comparator N11.1 in the control circuit. In overload condition this voltage is used by the control circuit to periodically switch-off the antenna.

A further protection circuit, consisting of diodes V5 and V6 is provided at the output of the variable frequency filter 1 to 30 MHz. This circuit is activated whenever the rectified HF voltage exceeds the Zener voltage of diode V7. Therefore in reception the amplifier stage V12 is protected against destruction due to high voltages in the pass-band.

5.1.2 Transmitted-signal Path

In transmission the HF signal is routed in at plug X53 in the HF circuit. It is then fed via relay K4 (4, 8) to the noise and distortion-free amplifier stage V12. In here the HF signal is amplified to compensate for the transfer attenuation of the subsequent filter circuit.

Depending upon the transmission frequency the transmission signal is fed via one of the five band-pass filters to plug X12 in the control circuit. From there it is fed via relay K5 (4, 8) and via plug X54 to the HF amplifier.

A diode V53 on plug X54 measures the HF signal the result of which is fed to comparator N11.2. If the measured value is below a predetermined threshold voltage on N11.4 as defined by resistors R91 to R93 the comparator N11.2 generates a failure message (CM signal) for the processor of the HF transmitter/receiver or HF receiver.

5.1.3 Test-signal Path

After a test routine has been triggered on the Control Unit GB 853C1 of the HF transmitter/receiver or HF receiver a 900-kHz line spectrum, 30 MHz in width is fed from the synthesizer into the motor-tuned filter via plug X56.

This signal can be reduced with the 40-dB attenuator consisting of R149 to R151. It is fed through the complete received-signal path of the motor-tuned filter beginning at relay K1. The signal serves for fault detection.

5.2 Control Circuit

5.2.1 General

In the standard approach of a follow-on control circuit the control value results from the difference of the nominal and actual value sensors.

In difference to this the motor-tuned filter does not possess an actual value sensor.

(Continuation)---

MOTOR-TUNED FILTER
FK 852P4

Repair Manual
 Part 5: Description of Function

- 5.3 -

---(Continuation) General

Either after switch-on of the power supply or subsequent to a frequency change the variable capacitor is first driven by the stepping motor to the so-called HOME position. Thereby a defined actual value is produced that in turn is used to calculate the control value.

The numerical value of the difference between nominal and actual value corresponds to the number of steps for the stepping motor. The mathematical sign defines the direction of rotation.

5.2.2 Motor Control Circuit

After switch-on of the HF transmitter/receiver or following a frequency change the control circuit does not have any position data of the variable capacitor. Therefore the stepping motor is triggered so that it first drives to the so-called HOME position.

In the HOME position the slots of the two control disks, one on the motor axle and one on the variable capacitor axle are inside the light barriers U1 resp. U2. In order to position the stepping motor in the HOME position the slot inside the control disk on the variable capacitor axle is wider. Therefore when the stepping motor approaches the HOME position the light barrier U2 is released first. This causes the control circuit to slow down the stepping motor which continues with slow speed until the slot of the control disk on the motor axle releases also light barrier U1.

Based upon this defined HOME position the control circuit computes the direction of rotation and the number of pulses for the stepping motor to get the variable capacitor to the new position corresponding to the selected frequency.

The light barriers U3 and U4 are controlled by the control disk on the variable capacitor axle. They mark beginning and end of the turning range in order to prevent the variable capacitor from jamming against the mechanical final stop.

The stepping motor is controlled by the processor via Schmitt trigger D1 and Darlington transistors V42 to V45. The Darlington transistor V41 and the transistor N8 (8, 9 and 10) together form a constant-current source providing approx. 1 A. This constant-current source can be switched by the processor via Schmitt trigger D1.12 and driver D4.9. When the stepping motor has come to its final position a current flows through resistor R43, through the switched-through control transistors V42 to V45 and through winding 1 to 4 of the stepping motor. This current generates a braking moment that acts like locking the motor.

As the stepping motor operates in half-step mode 2000 steps are required to proceed through the complete rotary range from beginning to end. That means that a new tuning in the frequency range I (1 to 2 MHz) can only be accomplished if the frequency difference is > 500 Hz. This frequency difference is doubled from one range to the next higher range. Therefore in the range V (16 to 30 MHz) a new tuning can only be accomplished if the frequency difference is > 8 kHz.

MOTOR - TUNED FILTER
FK 852P4

Repair Manual

Part 5: Description of Function

- 5.4 -

5.2.3 Relay Control Circuit

The relays of the motor-tuned filter are controlled by the Processor of the HF transmitter/receiver.

The control circuit receives the control signals for the range relays via plugs X51.b9 to .b13. The range relays switch-over the filters. The control signals are fed via Schmitt trigger D2 and driver D4 to the transistor arrays

N7 and N8. They then actually control the relays.

The control signals for the relays K1, K2 and K4 to K7 are generated by logic combination of the signals D0, D1, FBOE and transmit coming from the processor via plugs X51.a10, .a11, .b11, .b14 and .a18 together with the signal ŪL (overload).

MOTOR-TUNED FILTER
FK 852P4

Repair Manual
 Part 6: Repair

- 6.1 -

6. Repair

See circuit diagrams, parts lists and component layouts in the appendix to this repair manual (list on page 0.3).

6.1 Preliminary Remarks

The repair of the Motor-tuned Filter FK 852P4 consists of troubleshooting and fault elimination, of measurements alignments and functional checks, of replacing subassemblies and components as well as of a final inspection.

All the information required for repairing the motor-tuned filter down to component level is given in this part 6, repair.

For all alignment work and measurements the motor-tuned filter has to be supplied with the operating voltages given in the relevant circuit diagram.

All RF measurements on the filter are to be performed with the covers screwed down in place; if necessary, a special test cover must be produced for the purpose.

In RF measurements also ensure that cables and connections have the right characteristic impedance and that the connecting leads are as short as possible.

6.1.1 Troubleshooting Instructions

Any fault that occurs should be localized with the aid of the troubleshooting flowcharts given in 6.3.

6.1.2 Restoring the Nominal Characteristics

Any component that is definitely proved to be defective - through use of the troubleshooting flowcharts or by performing the alignments, measurements and functional checks - should only be replaced by a component that meets the specifications given in the parts lists in the appendix to this repair manual.

Only in this way can the technical data be guaranteed that are given in part 1 of the user manual.

Once components have been replaced, it is absolutely essential that the final inspection detailed in 6.6 is performed.

6.1.3 Spare Parts

All components and assemblies are subjected to strict quality assurance before they are allowed to be used in this item of equipment.

For components from outside suppliers, e.g. resistors, capacitors, diodes, transistors and integrated through to highly integrated circuits, R&S have set down their own delivery specifications for the purpose of ensuring maximum reliability. For this reason we recommend that only original spare parts are used, for replacing defective components.

(Continuation)---

MOTOR - TUNED FILTER
FK 852P4

Repair Manual
 Part 6: Repair

- 6.2 -

---(Continuation) Spare Parts

When ordering a spare part, please state the following:

type, ordering code and serial number of equipment, stock number of the parts list and designation plus stock number of the component concerned.

All of these details are to be found in the circuit diagrams, parts lists and component layouts that accompany the manual.

6.1.4 Important User Information

The following contains details which are essential when referring to Part 6 "Repair". This is in order to prevent misunderstandings at a later stage.

o All measurements are referred to ground, if not stated otherwise.

o Abbreviations in the text such as X42.a2 and B2.7 are to be understood as follows:

Connector 42 - pin a2

Integrated circuit 2 - pin 7

o The circuit diagrams on which the subsequent mentioned components can be found are referred to in the following troubleshooting flowcharts.

CAUTION CMOS

Among the components incorporated in the motor-tuned filter are MOS, MOSFET and CMOS devices. Devices of this kind are extremely sensitive to high extraneous voltages. Static discharge can produce very high voltage spikes, which are capable of destroying these devices.

For this reason, when work is being carried out in the vicinity of these devices, i.e. unless a special CMOS work station is available, the following minimum requirements should be observed:

- conductive bench and floor coverings,

- chair or stool with conductive coverings,

- grounded, metallic work surface and conductive wrist-straps with a resistance of > 200 kohms, < 1 Mohm plus an insulated lead and plug,

- soldering iron with safety grounding,

- all conductive surfaces, wrist-straps and work surfaces must be interconnected by insulated leads,

- supply voltage must be disconnected when soldering is being performed.

6.2 Test Equipment

The test equipment given in the following list will be required for performing the repairs described in this part of the manual.

Equivalent items of test equipment can be used, of course, provided that their technical data are at least as good.

MOTOR-TUNED FILTER
FK 852P4

Repair Manual
Part 6: Repair

- 6.3 -

6.2.1 List of Test Equipment

No.	Test equipment, required technical data	Recommended R&S unit	Ordering code
1	Polyskop, 0 to 40 MHz with log. amplifier and demodulator	SWOB 5 SWOB 5 E3 SWOB 5 Z1	333.0019.53 349.3512.02 333.7513.52
2	2 Signal generators 0.1 to 40 MHz output level 0 to 13 dBm	SMK	348.0010.02
3	Vector analyzer 0.1 to 40 MHz with tuner 2 Insertion adapter Feed unit	ZPV ZPV-E2 ZPV-Z1 ZPV-Z2	291.4012.93 292.0010.02 292.2713.50 292.2913.50
4	Noise generator 1 to 40 MHz $R_i = 50$ ohms	SKTU	100.4688.50
5	Test Receiver 1 to 30 MHz	ESH 3	335.8017.52
6	RF Millivoltmeter 0.1 to 30 MHz 700 μ V to 100 V 10 V RF insertion unit	URV 4 URV-Z2	292.5012.03 288.8010.55
7	RF step attenuator 0 to 30 MHz 0 to 6 dB	DPSP	334.6010.02
8	Digital multimeter 0 to 30 V	UDL 33	388.8011.02
9	Power splitter/combiner 0.1 to 40 MHz	DVS	342.1014.50
10	Spectrum analyzer	FSA	804.8010.52
11	High-power Attenuator 30 dB / 100 W	RBU 100	100.8654.35
12	High-power Attenuator 3 dB / 80 W	RBU 80	100.8654.05
13	2 Termination 50 ohms/1 W	RNB	272.4910.50
14	HF Broadband amplifier 0 to 50 dBm $R_i = 50$ ohms		
15	HF Switch-over 1-way		
16	Power Supply 0 to 15 VDC / 2 A	NGPU 70/20	192.0055.92

(Continuation)---

MOTOR-TUNED FILTER
FK 852P4

Repair Manual
Part 6: Repair

- 6.4 -

---(Continuation) List of Test Equipment

No.	Test equipment, required technical data	Recommended R&S unit	Ordering code
17	Power supply 0 to 10 VDC / 1 A	NGMD 35	117.7127.02
18	Service kit	KA 852C1	648.8513.02

6.3 Troubleshooting Flowchart

6.3.1 General

The following troubleshooting flowcharts (Fig. 6.1 to 6.5) cover troubleshooting as well as the elimination of faults in the Motor-tuned Filter FK 852P4.

To make the troubleshooting as straightforward as possible, there

are, where necessary, cross-references to other measurements and procedures involved in repair.

The given sequence for the troubleshooting should be adhered to so that faults can be detected and remedied as speedily and rationally as possible.

MOTOR-TUNED FILTER
FK 852P4

Repair Manual
 Part 6: Repair

- 6.5 -

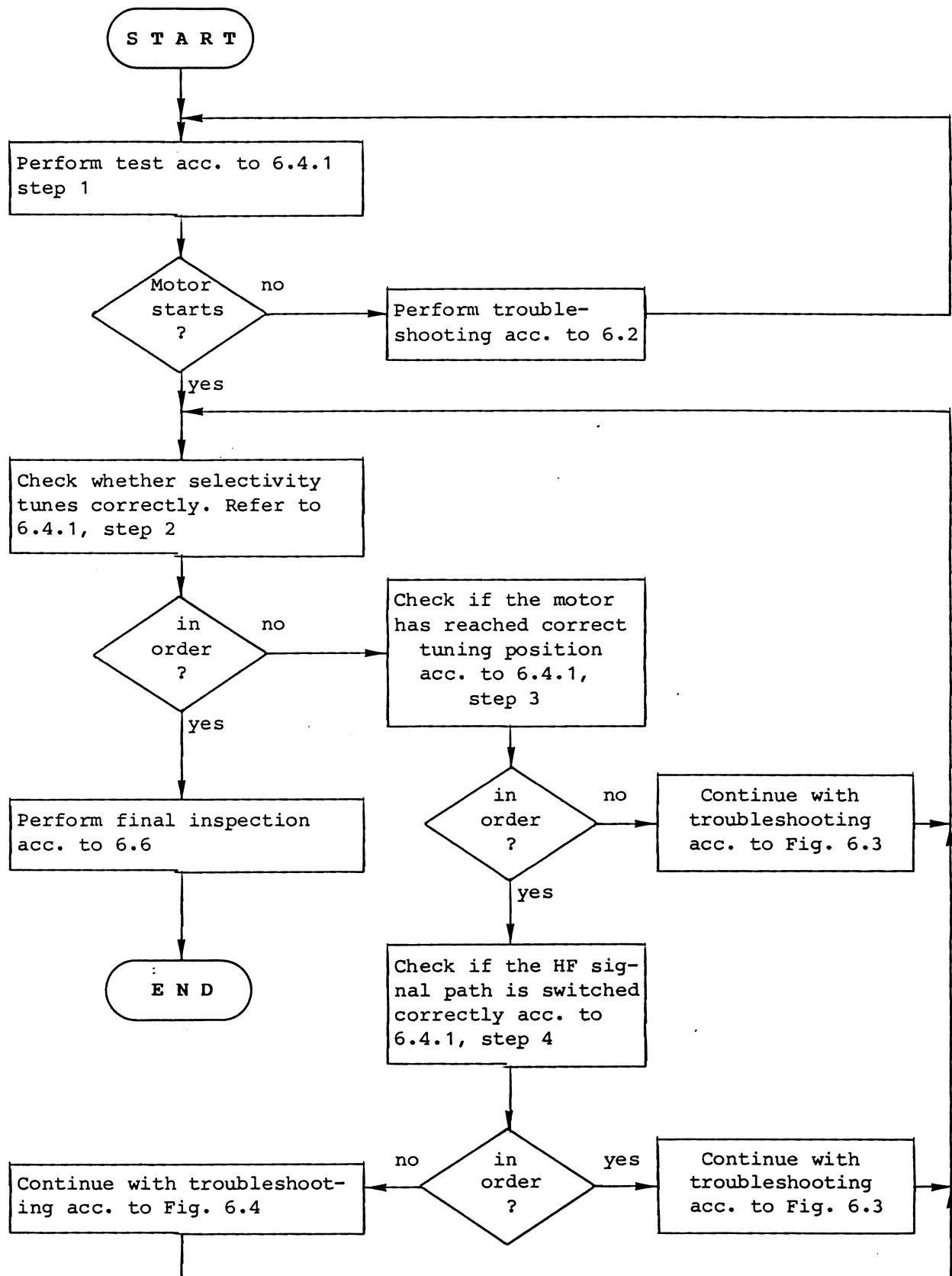

Fig. 6.1 Troubleshooting Flowchart

MOTOR-TUNED FILTER
FK 852P4

Repair Manual
Part 6: Repair

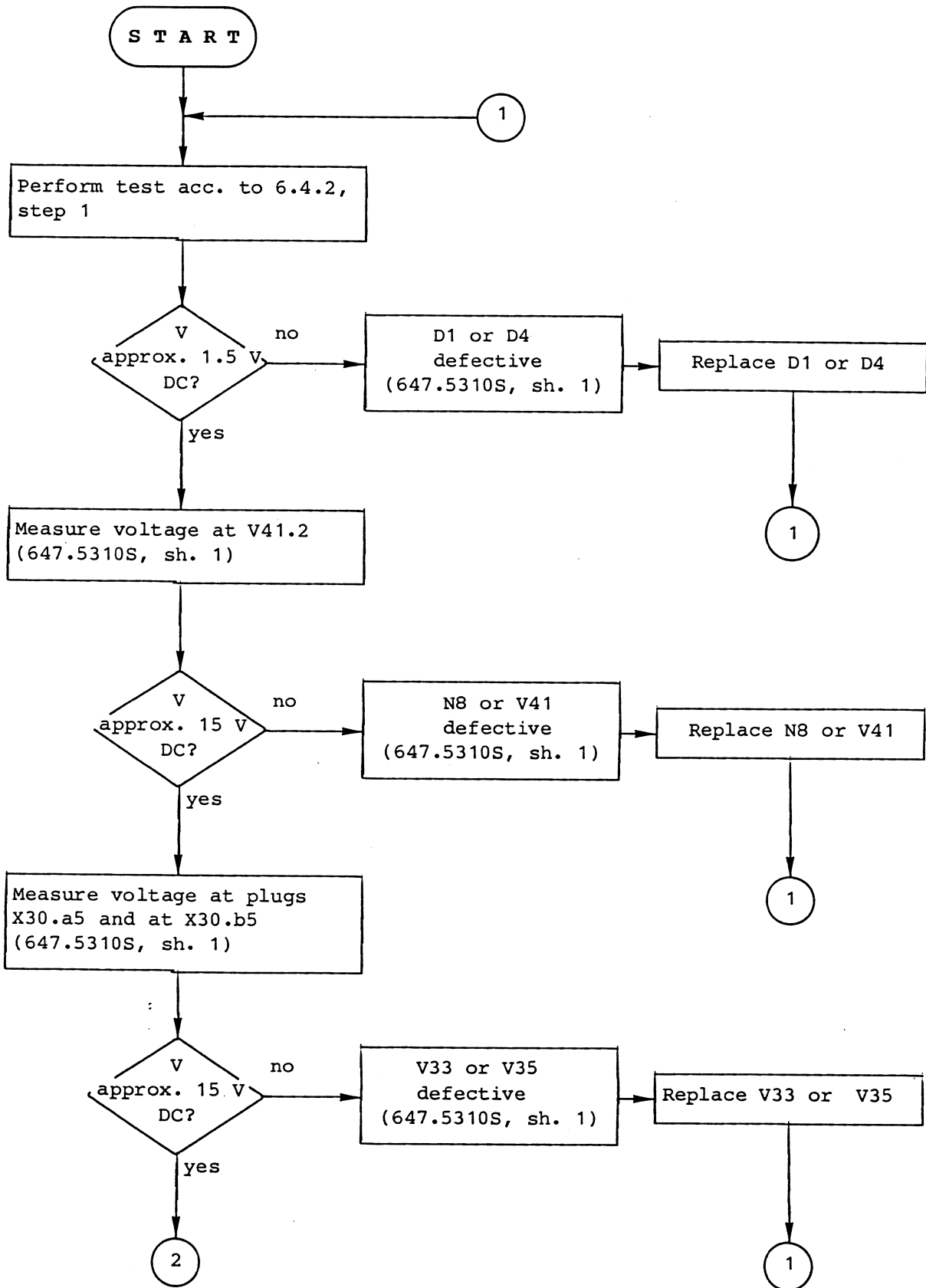

Fig. 6.2 Motor Control Circuit, Troubleshooting Flowchart
(page 1 of 3)

MOTOR-TUNED FILTER
FK 852P4

Repair Manual
Part 6: Repair

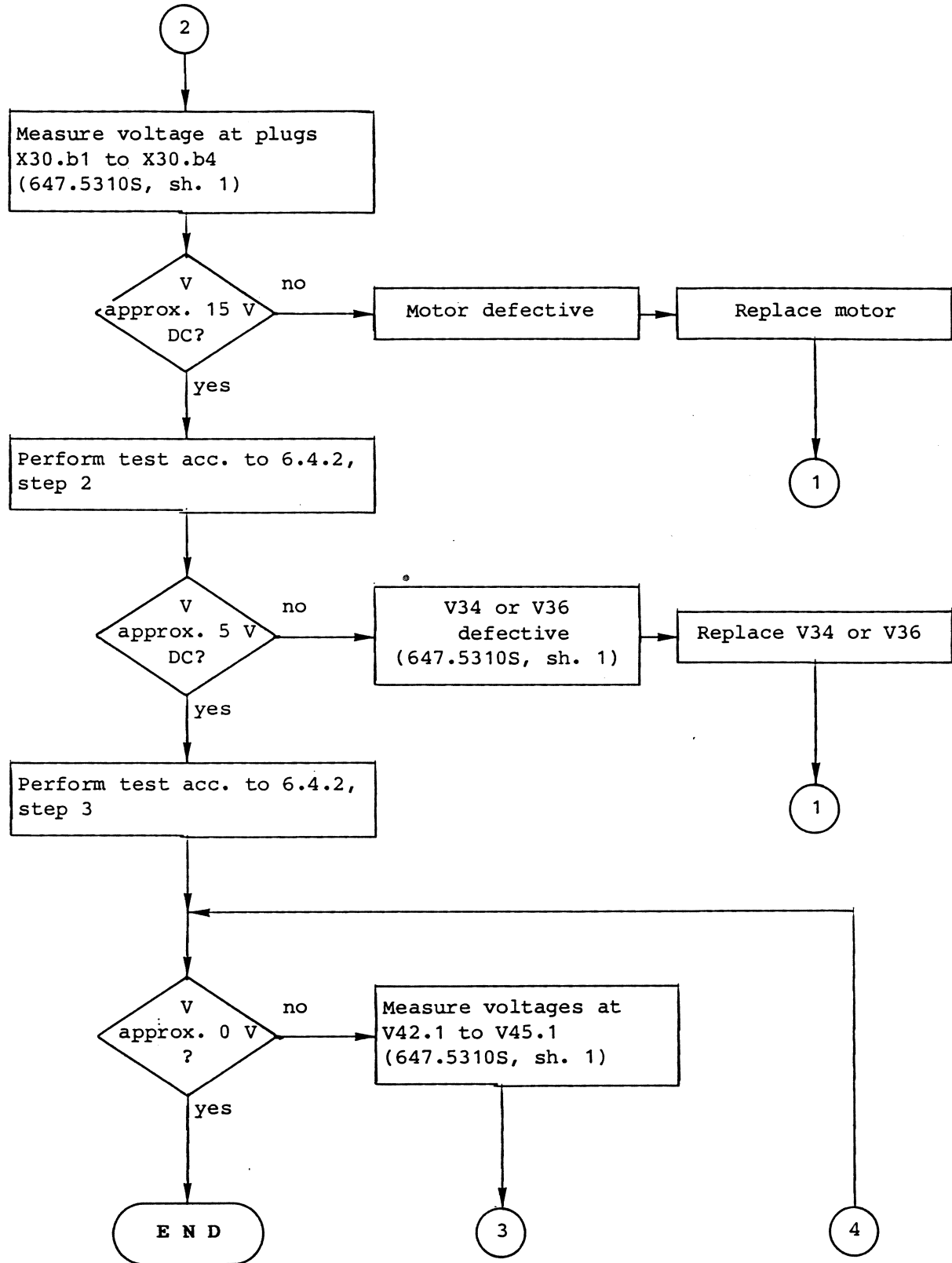
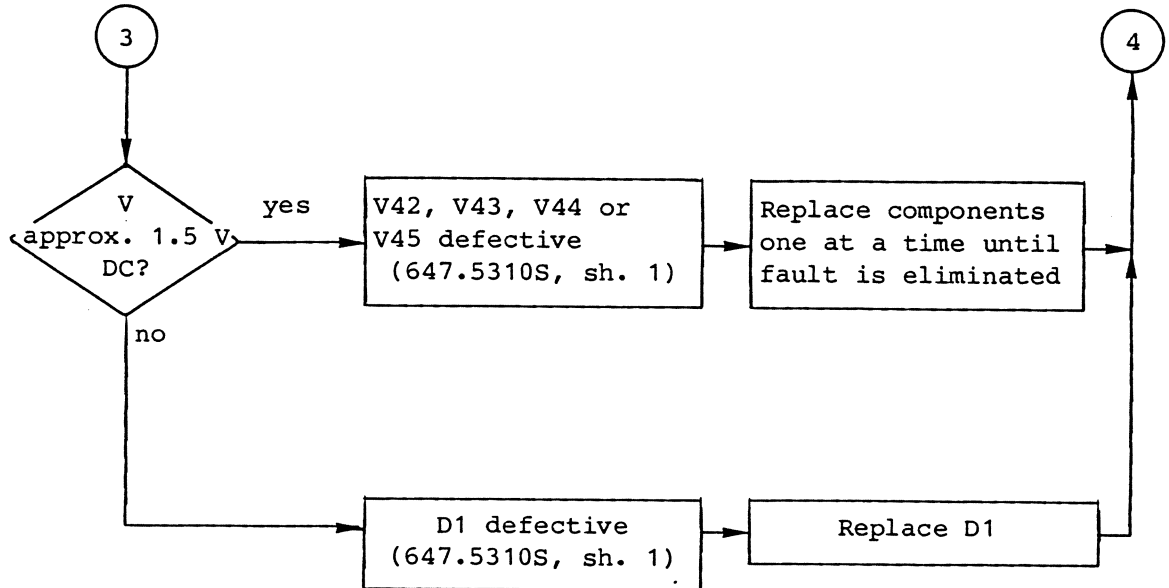

Fig. 6.2 Motor Control Circuit, Troubleshooting Flowchart
(page 2 of 3)

MOTOR-TUNED FILTER
FK 852P4Repair Manual
Part 6: Repair

- 6.8 -

Fig. 6.2 Motor Control Circuit, Troubleshooting Flowchart
(page 3 of 3)

MOTOR-TUNED FILTER
FK 852P4

Repair Manual
Part 6: Repair

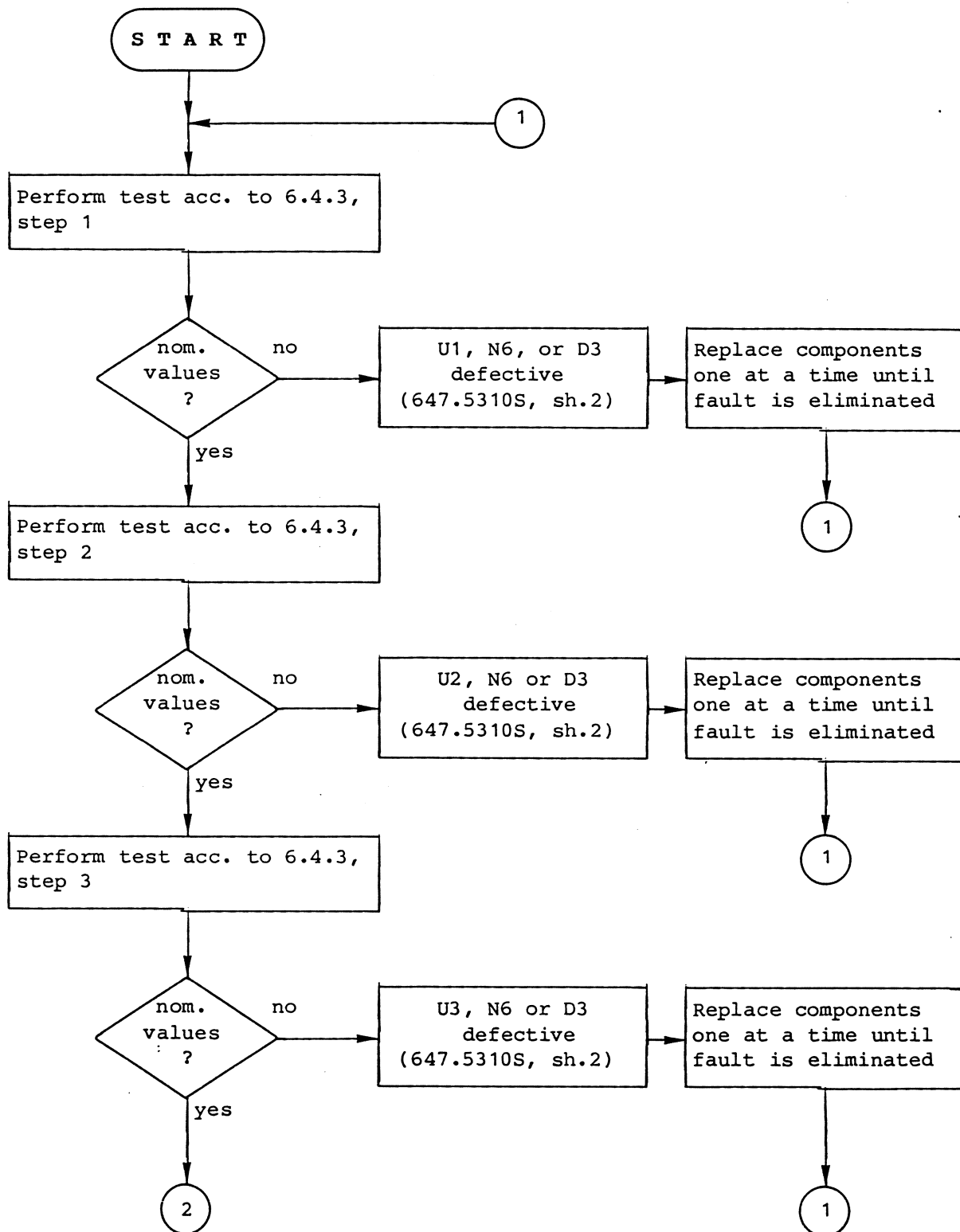
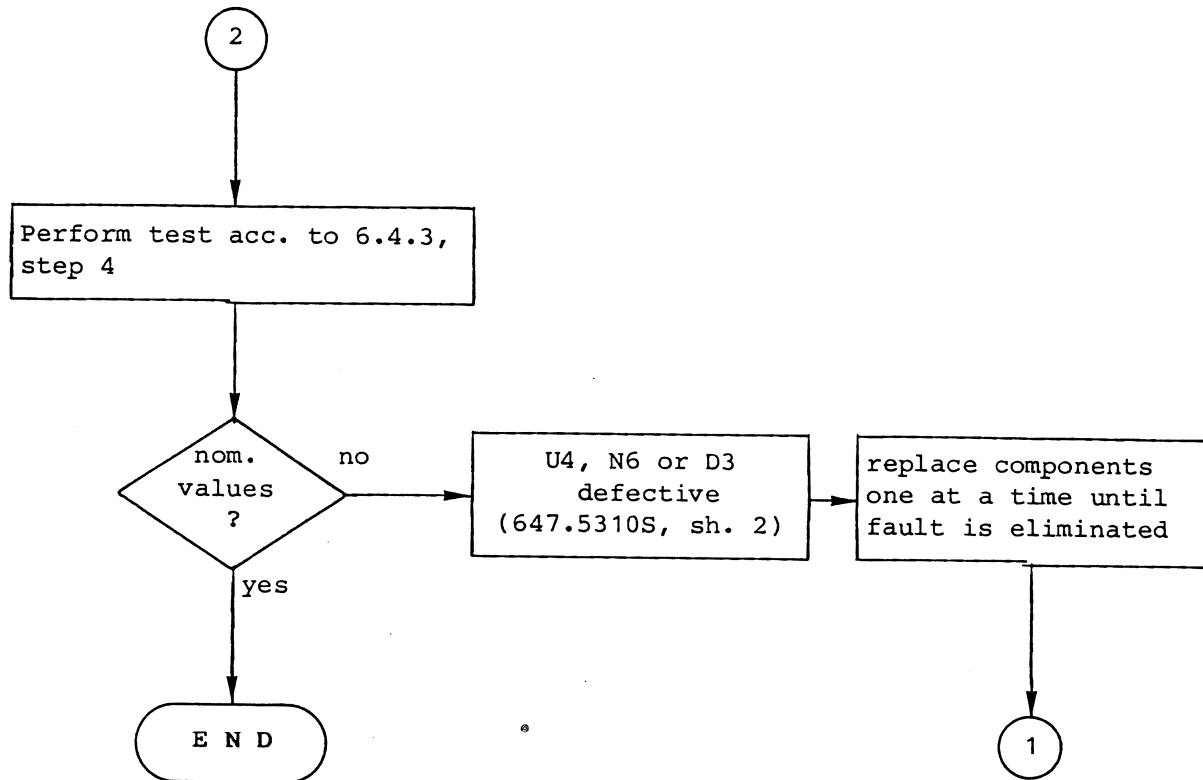

Fig. 6.3 Light Barrier Control Circuit, Troubleshooting Flowchart
(page 1 of 2)

MOTOR-TUNED FILTER
FK 852P4Repair Manual
Part 6: Repair

- 6.10 -

Fig. 6.3 Light Barrier Control Circuit, Troubleshooting Flowchart
(page 2 of 2)

MOTOR-TUNED FILTER
FK 852P4

Repair Manual
Part 6: Repair

- 6.11 -

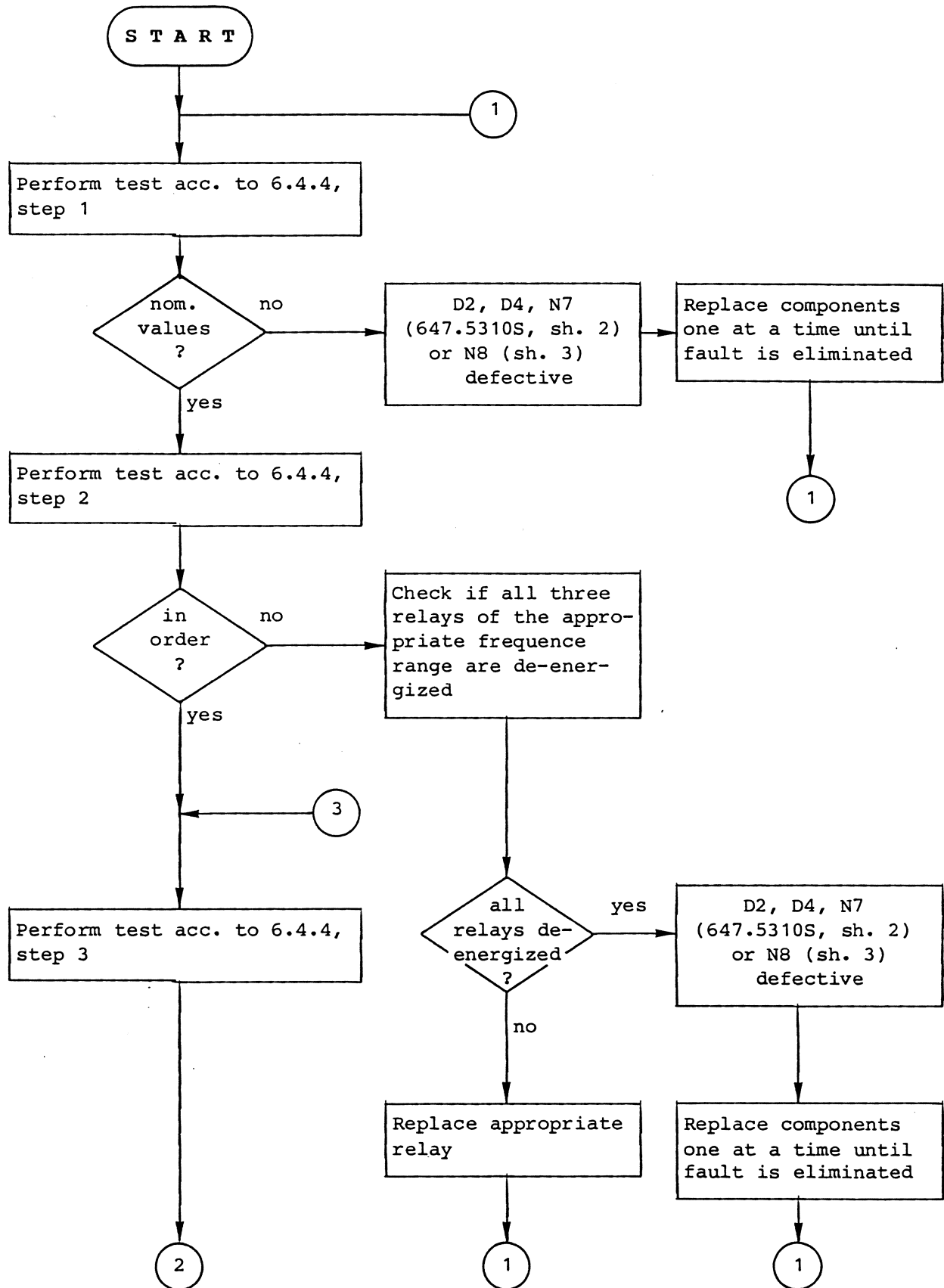

Fig. 6.4 Relay Control Circuit, Troubleshooting Flowchart
(page 1 of 3)

MOTOR - TUNED FILTER
FK 852P4

Repair Manual
Part 6: Repair

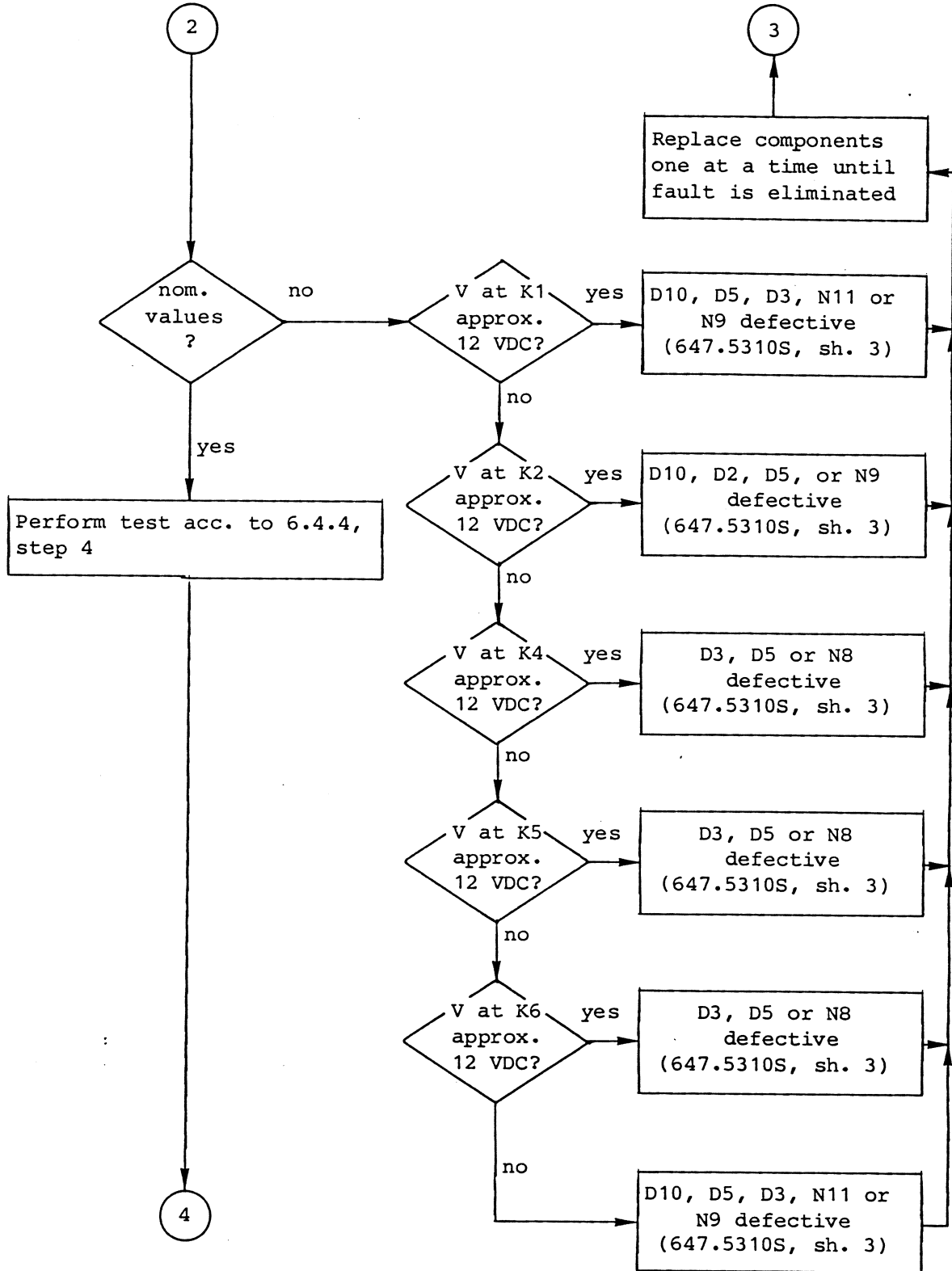
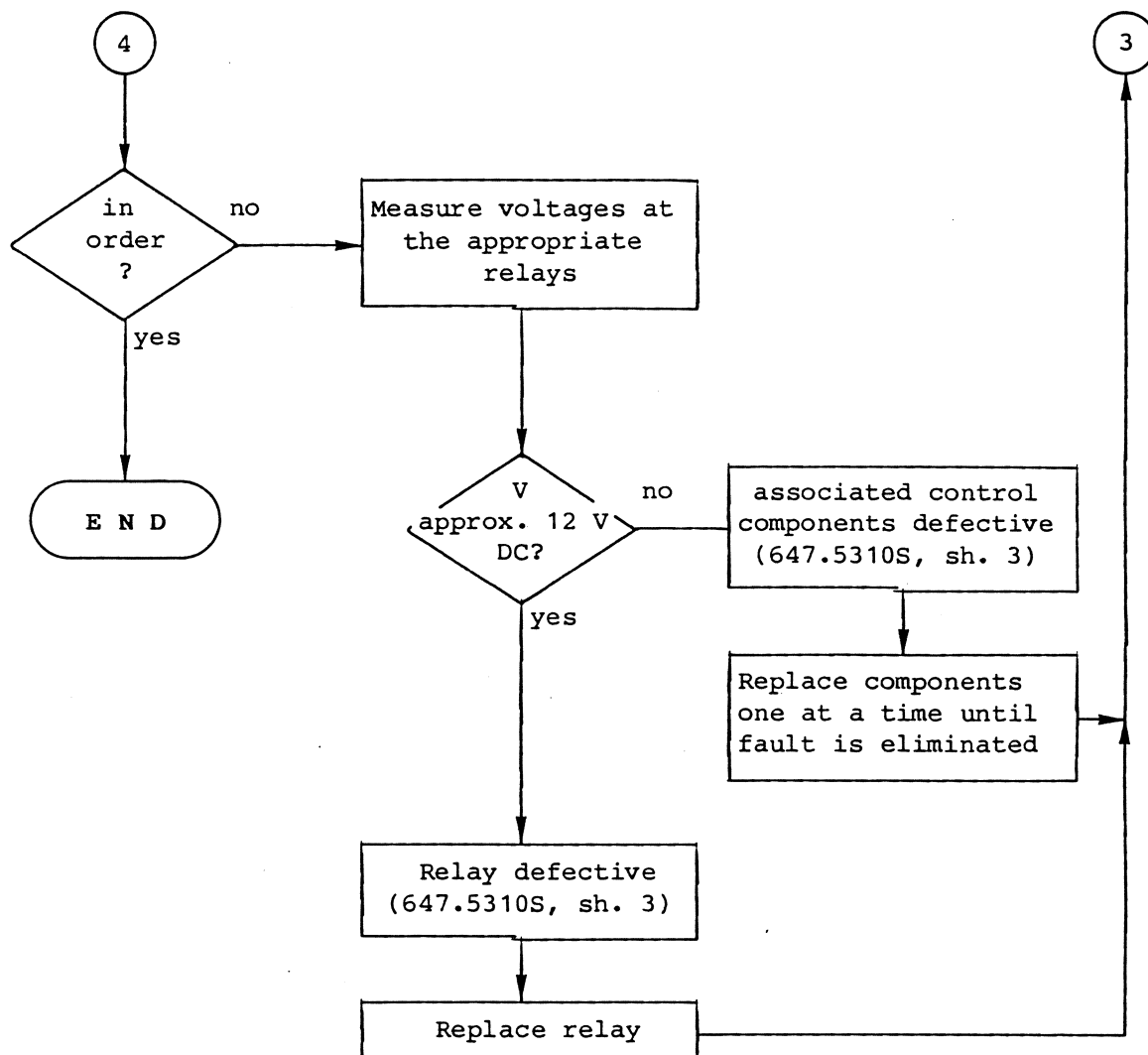

Fig. 6.4 Relay Control Circuit, Troubleshooting Flowchart
(page 2 of 3)

MOTOR-TUNED FILTER
FK 852P4Repair Manual
Part 6: Repair

- 6.13 -

Fig. 6.4 Relay Control Circuit, Troubleshooting Flowchart
(page 3 of 3)

MOTOR-TUNED FILTER
FK 852P4

Repair Manual
Part 6: Repair

- 6.14 -

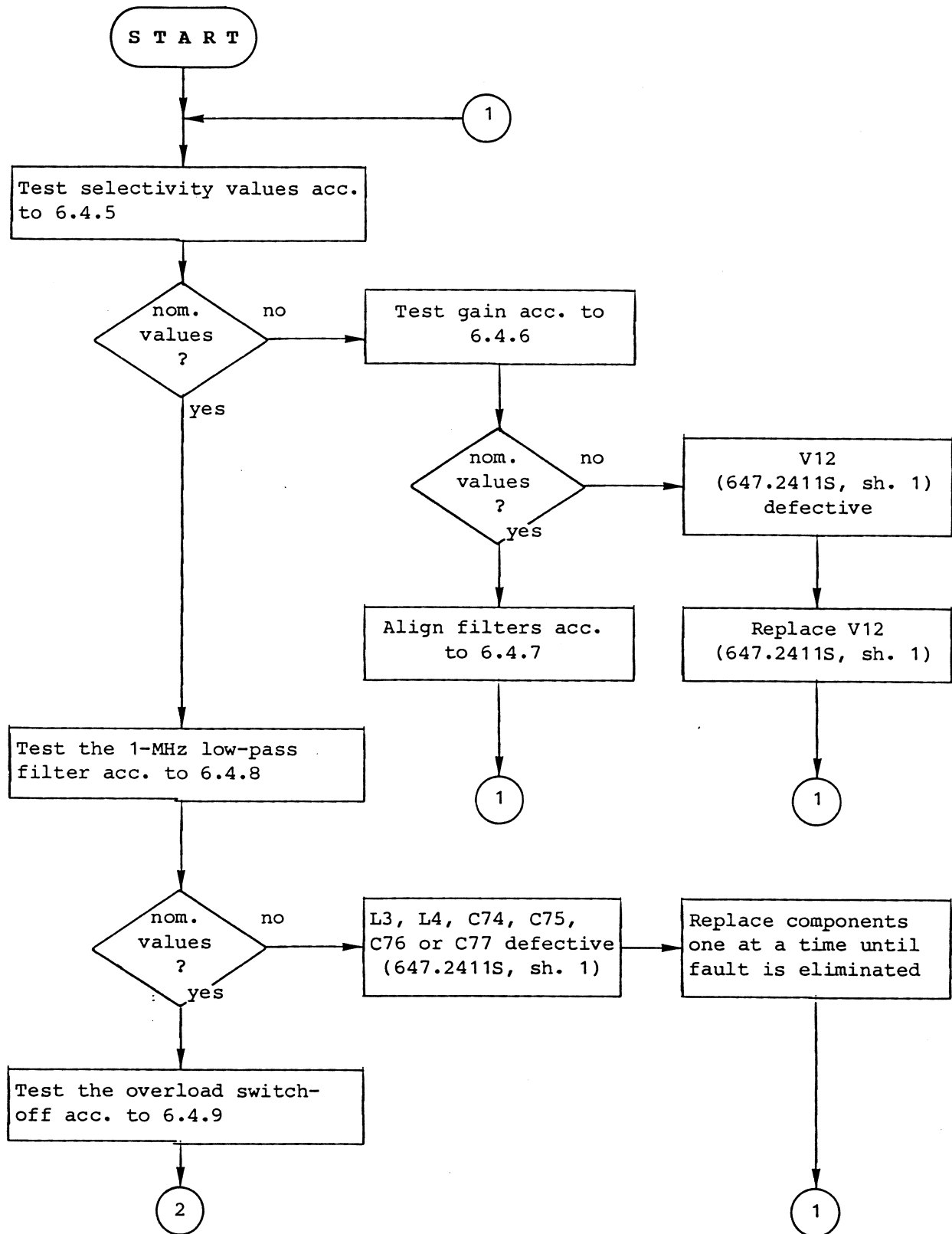

Fig. 6.5 HF Circuit, Troubleshooting Flowchart
(page 1 of 2)

MOTOR-TUNED FILTER
FK 852P4

Repair Manual
 Part 6: Repair

- 6.15 -

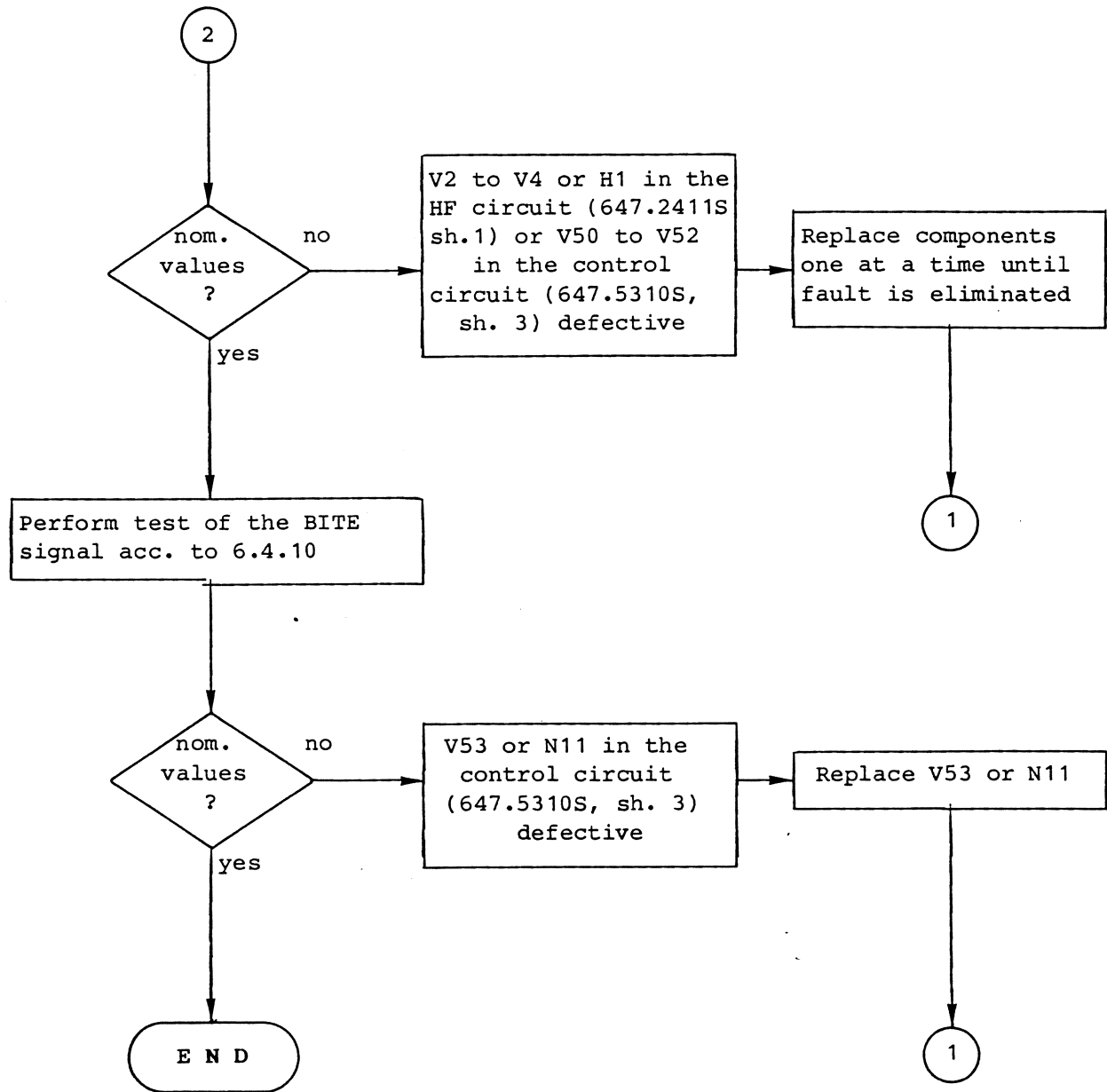

Fig. 6.5 HF Circuit, Troubleshooting Flowchart
 (page 2 of 2)

MOTOR-TUNED FILTER
FK 852P4

Repair Manual
 Part 6: Repair

- 6.16 -

6.4 Measurements, Alignments and Functional Checks

The measurements, alignments and functional checks that are described below are the more detailed procedures to the instructions given in a condensed form in the troubleshooting flow-charts. Consequently one will usually undertake these measurements, alignments and functional checks by branching out of the troubleshooting flow-chart at a particular point. On completion of these procedures continue with troubleshooting, returning to the respective point in the flowchart.

If a fault has been clearly identified beforehand however, you can of course commence with one of these measurements, etc. directly.

For all of these measurements or tests it is assumed that the Motor-tuned Filter FK 852P4 is properly adapted to an HF transmitter/receiver or HF receiver. For opening the motor-tuned filter refer to 6.5.

6.4.1 Checking the Motor-tuned Filter

1. Adapt the motor-tuned filter to a HF transmitter/receiver.
 - a) Set the OPERATION MODE switch on the control unit to Rx and select a frequency between 1 and 30 MHz.
 - b) Check if the motor starts to run.
2. Arrange a test set-up acc. to Fig. 6.13.
 - a) Set the OPERATION MODE switch on the control unit to Rx.
 - b) Set the SWOB 5 to an output level of 0 dB (0.5 V) and to a frequency range of 1 to 30 MHz.
 - c) Select one frequency out of each frequency range of the control unit and check the pass-band curve of the motor-tuned filter on the SWOB 5.

Maximum of the curve must be at the selected frequency.

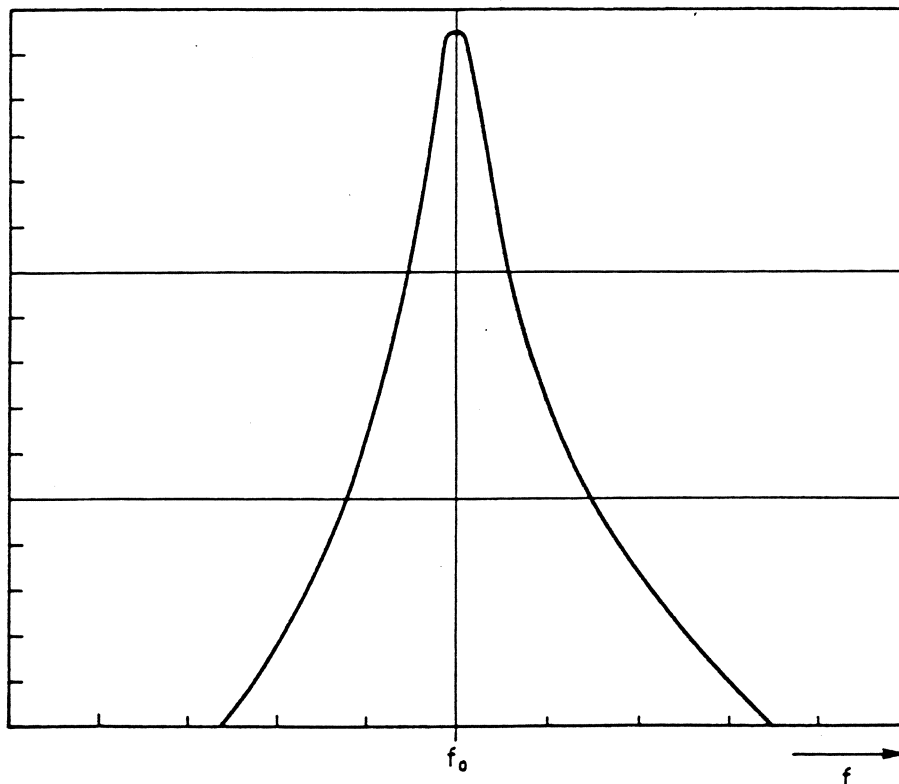

(Continuation)---

MOTOR-TUNED FILTER
FK 852P4

Repair Manual
 Part 6: Repair

- 6.17 -

---(Continuation) Checking the Motor-tuned Filter

3. Ensure that the motor-tuned filter is adapted to an HF transmitter/receiver.

- a) Set the OPERATION MODE switch on the control unit to Rx and select a frequency of 1.5 MHz.
- b) Check whether the slots of the control disks on the motor and on the variable capacitor axles are in the light barriers U1 or U2 respectively.

4. **C A U T I O N**

For the following measurements the motor-tuned filter may not be adapted to an HF transmitter/receiver.

- a) Connect operating voltages as follows:
 - +5.3 VDC to plug X51.a25/.b25
 - +15 VDC to plug X51.a29/.b29
 - 0 VDC to plug X51.a32/.b32
- b) Connect +5.3 VDC to plug X51.a18 and ground to plugs X51.b14, .a10, .a11 and to X10.1.
- c) Check whether relays K4 to K6 are energized.
- d) Connect +5.3 VDC to plug X51.b14 and ground to plugs X51.a10, .a11, .a18 and to X10.1.
- e) Check whether relays K1, K5, K6 and K7 are energized.
- f) Connect plugs X51.b14, .a10, .a11, .a18 and X10.1 to ground.
- g) Check whether relays K1 and K7 are energized.

6.4.2 Checking the Motor Control Circuit

C A U T I O N

For the following check the motor-tuned filter may not be adapted to an HF transmitter/receiver.

- 1. Connect operating voltages as follows:
 - +5.3 VDC to plug X51.a25/.b25
 - +15 VDC to plug X51.a29/.b29
 - 0 VDC to plug X51.a32/.b32

- a) Connect +5.3 VDC to plug X51.b7 and to plugs X51.b3 to X51.b6.

- b) Measure voltage at V41.1.

Nominal value: approx. 1.5 VDC.

- 2. Connect +5.3 VDC to plugs X51.b3 to X51.b6 and ground to plug X51.b7.

- a) Measure voltages at plugs X30.b1 to X30.b4.

Nominal value: approx. 5 VDC.

- 3. Connect ground to plug X51.b7 and to X51.b3 up to X51.b6.

- a) Measure voltages at plugs X30.b1 to X30.b4.

Nominal value: approx. 0 VDC.

6.4.3 Checking the Light Barrier Control Circuit

C A U T I O N

For the following check the motor-tuned filter may not be adapted to an HF transmitter/receiver.

(Continuation)---

MOTOR - TUNED FILTER
FK 852P4

Repair Manual
 Part 6: Repair

- 6.18 -

---(Continuation) Checking the Light
 Barrier Control Circuit

Connect operating voltage as follows:

+5.3 VDC to plug X51.a25/.b25
 +15 VDC to plug X51.a29/.b29
 0 VDC to plug X51.a32/.b32

- | | |
|---|--|
| <p>1. Manually rotate motor axle until the slot of the control disk is within the light barrier U1.</p> <p>a) Measure voltage at plug X51.b15.</p> <p>Nominal value: approx. 5 VDC</p> <p>b) Manually rotate motor axle until the slot of the control disk is outside the light barrier U1.</p> <p>c) Measure voltage at plug X51.b15.</p> <p>Nominal value: approx. 0 VDC.</p> <p>2. Manually rotate motor axle until the slot of variable capacitor control disk is within the light barrier U2.</p> <p>a) Measure voltage at plug X51.b16.</p> <p>Nominal value: approx. 5 VDC.</p> <p>b) Manually rotate motor axle until the slot of the variable capacitor control disk is outside the light barrier U2.</p> <p>c) Measure voltage at plug X51.b15.</p> <p>Nominal value: approx. 0 VDC.</p> <p>3. Manually rotate motor axle until the slot of the variable capacitor control disk is within the light barrier U3.</p> <p>a) Measure voltage at plug X51.b17.</p> <p>Nominal value: approx. 5 VDC.</p> | <p>b) Manually rotate motor axle until slot of variable capacitor control disk is outside the light barrier U3.</p> <p>c) Measure voltage at plug X51.b17.</p> <p>Nominal value: approx. 0 VDC.</p> <p>4. Manually rotate motor axle until slot of variable capacitor control disk is within the light barrier U4.</p> <p>a) Measure voltage at plug X51.b18.</p> <p>Nominal value: approx. 5 VDC.</p> <p>b) Manually rotate motor axle until slot of variable capacitor control disk is outside the light barrier U4.</p> <p>c) Measure voltage at plug X51.b18.</p> <p>Nominal value: approx. 0 VDC.</p> |
|---|--|

6.4.4 Checking the Relay Control Circuit

C A U T I O N

For the following check the motor-tuned filter may not be adapted to an HF transmitter/receiver.

Connect operating voltages as follows:

+5.3 VDC to plug X51.a25/.b25
 +15 VDC to plug X51.a29/.b29
 0 VDC to plug X51.a32/,b32

1. Connect ground to plugs X51.b9 to X51.b13.

(Continuation)---

MOTOR-TUNED FILTER
FK 852P4

Repair Manual
 Part 6: Repair

- 6.19 -

---(Continuation) Checking the Relay
 Control Circuit

- a) Measure voltages at plugs X10.2 to X10.6. a) Connect +5.3 VDC to plugs X51.a10 and X51.a9.
- Nominal values: approx. 0 VDC. b) Measure voltages at relays K1, K2 and at K4 to K7.
2. Individually and one after the other connect +5.3 VDC to plugs X51.b9 to X51.b13. Nominal values: approx. 0 VDC.
- a) Check if the appropriate relays of the relevant frequency range are energized. 4. Connect +5.3 VDC or 0 VDC to the plugs acc. to the table set out below.
3. Connect ground to plugs X51.b14, .a18, .a11 and to X10.1. a) Switch +5.3 VDC to plug X51.a9 and check if the relays given in the table are energized.

Connect X51.					Relay is energized						Associated control components
b14	a18	a10	a11	X10 .1	K1	K2	K4	K5	K6	K7	
0	1	0	0	0			X	X	X		D3, D5, N8
1	0	0	0	0	X			X	X	X	D3, D5, D10, D12, N8, N9, N11
1	0	1	0	0				X	X		D3, D5, N8
1	0	1	1	0		X		X	X		D2, D3, D5, D10, N8, N9
1	0	0	0	1	X			X	X		D3, D5, D10, N8, N9, N11
0	0	0	0	0	X					X	D3, D5, D10, D12, N9, N11
0	0	1	1	0		X					D2, D5, D10, N9
0	0	0	0	1	X						D3, D5, D10, N9, N11

1 = +5.3 VDC, 0 = 0 VDC, X = Relay is energized

6.4.5 Checking the Selectivity

1. Prepare test set-up acc. to Fig. 6.14.
2. Set the OPERATION MODE switch on the control unit to Rx.
3. Set the output level of the SMK to 10 dBm.

(Continuation)---

MOTOR-TUNED FILTER
FK 852P4

Repair Manual
Part 6: Repair

- 6.20 -

---(Continuation) Checking the Selectivity

4. Set the HF transmitter/receiver, the SMK and the ZPV all to the same frequency acc. to the following table.
5. Store the gain as a reference value in the ZPV.
6. Set SMK and ZPV to same frequency acc. to column 2 to 5 and measure the selectivity values.

1	2	3	4	5
1.0000 1.9999	0.9 1.8	0.95 1.9	1.05 2.1	1.1 2.2
2.0000 3.9999	1.8 3,6	1.9 3.8	2.1 4.2	2.2 4.4
4.0000 7.9999	3.6 7.2	3.8 7.6	4.2 8.4	4.4 8.8
8.0000 15.9999	7.2 14.4	7.6 15.2	8.4 16.8	8.8 17.6
16.0000 29.9999	14.4 27.0	15.2 28.5	16.8 31.5	17.6 33.0

Note: All frequencies listed in MHz

Nominal values: Attenuation > 25 dB at 5 % distance of the set frequency
Attenuation > 40 dB at 10 % distance of the set frequency

6.4.6 Checking the Gain

1. Prepare test set-up acc. to Fig. 6.15.
2. Set OPERATION MODE switch on control unit to Rx.
3. Set output level of SMK to 10 dBm.
4. Set the HF transmitter/receiver to the following frequencies:
5. For each frequency measure the gain.

Nominal values:

$v = 0$ to -1 dB in the frequency range of 400 to 999 kHz.

$v = 0$ to $+3$ dB in the frequency range of 1 to 30 MHz.

400 kHz 1.0000 MHz 2.0000 MHz
999 kHz 1.9999 MHz 3.9990 MHz

4.0000 MHz 8.0000 MHz 16.0000 MHz
7.9999 MHz 15.9999 MHz 29.9999 MHz

MOTOR-TUNED FILTER
FK 852P4

Repair Manual
 Part 6: Repair

- 6.21 -

6.4.7 Alignment of the HF Circuit

1. Prepare test set-up acc. to Fig. 6.15.
2. Set OPERATION MODE switch on control unit to Rx.
3. Set output level of SMK to 10 dBm.
4. Unscrew and remove cover of the HF circuit.
5. Screw rotors of trimming capacitors C11 to C53 by 90° counterclockwise out of the stators.
6. Screw cover back in place.
7. Set HF transmitter/receiver to frequencies acc. to following table.
8. At the lower range limit adjust the 3 resonators of each sub-range to maximum output voltage by rotating the coil cores.
9. At the upper range limit adjust by rotating the trimming capacitors.
10. Repeat above adjustment at lower and upper range limit in turn until no further raise of maximum voltage can be reached.

C A U T I O N

Always perform last adjustment at the upper range limit using the trimming capacitors.

Sub-range	Frequency [*] setting in MHz	Adjustment to maximum with		
		1st circuit	2nd circuit	3rd circuit
I	1.0000	L11	L12	L13
	1.9999	C11	C12	C13
II	2.0000	L21	L22	L23
	3.9999	C21	C22	C23
III	4.0000	L31	L32	L33
	7.9999	C31	C32	C33
IV	8.0000	L41	L42	L43
	15.9999	C41	C42	C43
V	16.0000	L51	L52	L53
	29.9999	C51	C52	C53

6.4.8 Alignment of the 1-MHz Low-pass Filter

1. Prepare test set-up acc. to Fig. 6.15.
2. Set OPERATION MODE switch on the control unit to Rx and set to a frequency of 500 kHz.
3. Set output level of SMK to 13 dBm.
4. Set frequencies of 1.0 MHz, 1.8 MHz and 2.8 MHz one after the other on the SMK.
5. For each frequency measure the attenuation.

Nominal values:

- a = - 1 dB for f < 1 MHz
 a = -25 dB for f > 1.8 MHz
 a = -50 dB for f > 2.8 MHz

MOTOR-TUNED FILTER
FK 852P4

Repair Manual
Part 6: Repair

- 6.22 -

6.4.9 Checking the Overload
Switch-off Circuit

1. Prepare test set-up acc. to Fig. 6.16.
2. Set OPERATION MODE switch on the control unit to Rx and select $f_M = 1.5$ MHz.
3. Set SMK to $f_M = 1.5$ MHz and to an output level of 0 dBm.
4. Set the HF switch to position 1-2.
5. Increase signal level of the amplifier until 791 mV is displayed on the URV.
6. Set ESH3 to a frequency of 1.5 MHz.
7. Set the HF switch to position 1-3.
8. Measure the periodical switch-off time.

Nominal value: 2 ± 0.4 s.
9. Repeat the above checks for the following f_M frequencies:

$f_M = 3$ MHz, 6 MHz, 12 MHz and 24 MHz.

6.4.10 Checking the BITE Signal

1. Prepare test set-up acc. to Fig. 6.17.
2. Set the OPERATION MODE switch on the control unit to Tx/Rx.
3. On the control unit select CW and low power.
4. Set the HF transmitter/receiver and the SMK to 1.5 MHz and on the AF adapter switch to carrier activation (PTT).
5. Set the output level of the SMK so that the URV displays a voltage of 500 mV.

6. Read voltage as indicated on the UDL33.

Nominal value: > 5 V.
7. Set the output level of the SMK so that the URV displays a voltage of 300 mV.
8. Read voltage as indicated on the UDL33.

Nominal value: < 0.3 V.
9. Repeat the above checks with the frequencies of $f = 15$ MHz and $f = 25$ MHz.

6.5 Replacement of Subassemblies and Components

6.5.1 Removal of Subassemblies

Preliminary work:

1. Loosen and remove screws on the HF circuit.
2. Take off cover of the HF circuit.
3. Loosen and remove screws on the control circuit.
4. Take off cover of the control circuit.

6.5.1.1 Variable Capacitor and Gearbox

1. Perform preliminary work acc. to 6.5.1.
2. First mark and then unsolder the 3 connection bands (9, Fig. 6.6) on the variable capacitor (10).

(Continuation)---

MOTOR - TUNED FILTER
FK 852P4

Repair Manual
Part 6: Repair

- 6.23 -

---(Continuation) Variable Capacitor
and Gearbox

3. Remove the cover of the variable capacitor after undoing the three retaining screws.
4. Pull off two sockets (4) from the control circuit above the stepping motor (5).
5. Undo two screws (7) on the angular piece (not on the rotary capacitor!).
6. Undo four screws (6).
7. Carefully take out variable capacitor and gearbox.

6.5.1.2 Stepping Motor

1. Perform preliminary work acc. to 6.5.1.
2. Pull off two sockets (4) from the control circuit above the stepping motor (5).
3. Undo four screws (11) on the stepping motor.
4. Undo two special screws on the motor axle inside the gearbox.
5. Take out stepping motor.

6.5.1.3 Control Circuit

1. Perform preparatory work acc. to 6.5.1.
2. Remove HF cables W11 (2, Fig. 6.6) and W12 (3) from the connectors.
3. Unbend flaps on the separating walls and lift off the two cables towards the top.

4. Pull off two sockets (4) from the control circuit above the stepping motor (5).
5. Undo six screws (1).
6. Take out control circuit towards the top.

6.5.1.4 HF Circuit

1. Perform preparatory work acc. to 6.5.1.
2. Unsolder the three connection bands (9, Fig. 6.6) from the variable capacitor (10).
3. Undo three screws and take off cover of the rotary capacitor (this only applies to model .02).
4. Undo four screws (6).
5. Pull off two sockets (4) from the control circuit above the stepping motor (5).
6. Undo two screws (7) on the angular piece (not on the variable capacitor!).
7. Carefully withdraw variable capacitor and gearbox.
8. Remove HF cables W11 (2) and W12 (3) from the connectors.
9. Unbend flaps on the separating walls and lift off the two cables towards the top.
10. Undo nine screws (8).
11. Take out the HF circuit.

**MOTOR-TUNED FILTER
FK 852P4**

Repair Manual
Part 6: Repair

- 6.24 -

6.5.2 Reinstallation of
Subassemblies

6.5.2.1 Stepping Motor

The reinstallation of the subassembly is to be performed in the reverse order of the removal.

1. Clamp pinion on motor axle and pin them together (distance square motor flange - pinion: approx. 2.1 mm).
2. Install the motor by shifting the grip of the gear in the gearbox by two teeth and observe that the mechanical stop is reached (see Fig. 6.9).

4. Set rotor to 0° position. Rotate control disk 2 until the 0° marker is on the middle of the light barrier.
5. Fix control disk and gear.
6. Rotate the stepping motor clockwise up to the stop and check acc. to Fig. 6.12 if it securely blocks in that position.
7. Secure screws on the control disks and on the gear to the axle of the variable capacitor by means of varnish.

6.5.2.2 Variable Capacitor and
Gearbox

The installation of the subassemblies is to be performed in the reverse order of the removal.

CAUTION

For alignment of the tuning range the rotors must be mounted in a line on the common axle. The 0° position can be attained if the rotors are turned-in completely and if the rotor and stator edges are positioned in a line acc. to Fig. 6.7. This position is outside the tuning range.

For alignment of the tuning range proceed as follows:

1. Set the mechanical stop of the gearbox to mid position.
2. Adjust the control disk 1 to the middle of the light barrier acc. to Fig. 6.9 and screw tight.
3. Rotate the stepping motor 2 2/3 turns clockwise until the 0° marking is on the middle of the light barrier, acc. to Fig. 6.10.

6.5.3 Replacing Components

Components are replaced by following usual workshop procedure. No special instructions are necessary for this. When components have been replaced proceed once again with the troubleshooting flowcharts according to Figs. 6.1 to 6.5.

6.6 Final Inspection

After a repair has been carried out, the Motor-tuned Filter FK 852P4 must be subjected to the following final inspection to ensure that its technical data can still be guaranteed.

If this final inspection does not prove satisfactory, the testing and troubleshooting following the flowcharts Fig. 6.1 to 6.5 will have to be performed again. Repeat the procedure as many times as is necessary to detect and remedy all faults.

MOTOR-TUNED FILTER
FK 852P4

Repair Manual
 Part 6: Repair

- 6.25 -

6.6.1 Checking Intermodulation Distance in Transmission

1. Prepare test set-up according to Fig. 6.18.

Note:

At the motor-tuned filter use connector X53 for signal input and connector X54 for signal output.

C A U T I O N

Set both SMKs to the special function RCL-71.

2. Set the OPERATION MODE switch on the control unit to Tx/Rx.
3. Select on the control unit CW and low power.
4. Set the HF transmitter/receiver and the spectrum analyzer to a frequency of $f = 1.5$ MHz.
5. Set the SMK (A) and the SMK (B) to the following frequencies:

$f_1 =$ Measurement frequency -1 kHz
 $f_2 =$ Measurement frequency $+1$ kHz
6. Set the output levels of the SMKs so that the analyzer displays 7 dBm in both cases.
7. Read the D3 mixer product on the analyzer.

Nominal values: $a > 40$ dB

8. Repeat the above check with each of the following frequencies:

$f = 3$ MHz, $f = 6$ MHz, $f = 12$ MHz
 and $f = 24$ MHz.

6.6.2 Checking the Intermodulation Distance in Reception

1. Prepare test set-up acc. to Fig. 6.18.

Note:

On the motor-tuned filter use connector X52 for signal input and X55 for signal output.

C A U T I O N

Set both SMKs to the special function RCL-71.

2. Set the OPERATION MODE switch on the control unit to Rx.
3. Set the HF transmitter/receiver and the analyzer to a frequency of $f = 1.5$ MHz.
4. Set the SMK (A) and the SMK (B) to an output level of 3.5 dB and to the following frequencies:

$f_1 =$ Measurement frequency -1 kHz
 $f_2 =$ Measurement frequency $+1$ kHz

5. Read the D3 mixer product on the analyzer.

Nominal values: $a > 54$ dB.

6. Repeat the above check with each of the following frequencies:

$f = 3$ MHz, $f = 6$ MHz, $f = 12$ MHz
 and $f = 24$ MHz.

MOTOR-TUNED FILTER
FK 852P4Repair Manual
Part 6: Repair- 6.26 -

6.6.3 Checking the Noise Figure

1. Prepare the test set-up acc. to Fig. 6.19.
2. Set the OPERATION MODE switch on the control unit to Rx.
3. Set the control unit to a frequency of $f = 1.5$ MHz.
4. Set the DPSP to an attenuation level of 3 dB.
5. Note the reading on the ESH3.
6. Set the DPSP to an attenuation level of 6 dB and increase the output level of the SKTU until the previously noted value is indicated again on the ESH3.
7. Read the noise figure on the SKTU:

Nominal values: $F < 20 kT_0$
8. Repeat the above check with each of the following frequencies:

 $f = 3$ MHz, $f = 6$ MHz, $f = 12$ MHz and $f = 24$ MHz.

MOTOR-TUNED FILTER
FK 852P4

Repair Manual
Part 6: Repair

- 6.27 -

6.7 External Interfaces

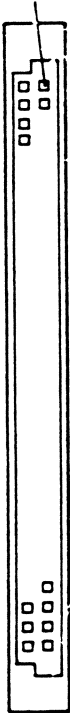
Connector X51	Pin	Signal designation/level
FP connector strip, 64-way, for printed cir- cuits, indirect Contact a1 	a 1	not used
	a 2	not used
	a 3	not used
	a 4	not used
	a 5	<u>BITE SELECTION</u> (TTL)
	a 6	not used
	a 7	not used
	a 8	not used
	a 9	Strobe (TTL)
	a 10	D0 (TTL)
	a 11	D1 (TTL)
	a 12	not used
	a 13	not used
	a 14	not used
	a 15	not used
	a 16	not used
	a 17	not used
	a 18	TRANSMIT (TTL)
	a 19	not used
	a 20	not used
	a 21	not used
	a 22	not used
	a 23	not used
	a 24	+5.3 VDC
	a 25	+5.3 VDC
	a 26	not used
	a 27	not used
	a 28	+15 VDC
	a 29	+15 VDC
	a 30	Ground
	a 31	Ground
	a 32	Ground
b 1	not used	
b 2	<u>not used</u>	
b 3	<u>MO1E</u> (TTL)	
b 4	<u>MO2E</u> (TTL)	
b 5	<u>MO3E</u> (TTL)	
b 6	<u>MO4E</u> (TTL)	
b 7	<u>MOT</u> (TTL)	
b 8	<u>MES</u> (TTL)	
b 9	<u>FB1E</u> (TTL)	
b 10	<u>FB2E</u> (TTL)	
b 11	<u>FB3E</u> (TTL)	

(Continuation)---

MOTOR-TUNED FILTER
FK 852P4

Repair Manual
Part 6: Repair

- 6.28 -

---(Continuation) External Interfaces

Connector X51 (Cont.)	Pin	Signal designation/level
	b 12	FB4E (TTL)
	b 13	FB5E (TTL)
	b 14	FB0E (TTL)
	b 15	LSM (TTL)
	b 16	LSH (TTL)
	b 17	LSA (TTL)
	b 18	LSE (TTL)
	b 19	not used
	b 20	not used
	b 21	not used
	b 22	not used
	b 23	not used
	b 24	+5.3 VDC
	b 25	+5.3 VDC
	b 26	not used
	b 27	not used
	b 28	+15 VDC
	b 29	+15 VDC
	b 30	Ground
	b 31	Ground
	b 32	Ground

Connector X52 to X56		Signal designation/level
FJ jack plugs, SMB system	X52	HF/receive 1
	X53	HF/transmit 2
	X54	HF/transmit 1
	X55	HF/receive 2
	X56	Test spectrum



ROHDE & SCHWARZ

Communications Division

Appendix

CIRCUIT DIAGRAMS

PARTS LISTS

COMPONENTS LAYOUTS

Für diese Unterlage behalten wir uns alle Rechte vor

Kennz. Comp.No.	Benennung Designation	Sachnummer Stock No.	Hersteller Manufacturer	Bezeichnung Designation	enthalten in contained in	
	VARIANTENERKL. / VERSIONS VAR 02 = GRUNDAUSFUEHRUNG MOD 02 = BASIC MODEL VAR 04 = AUSF.F.SK859L2 MOD 04 = VERS.F.SK859L2 VAR 05 = AUSF.EK085 MOD 05 = VERS.F.EK085					
A1	ZM DREHKO + GETRIEBE VARIABLE CAPACITOR + GEAR	647.2192				
A2	ED HF-TEIL RF CIRCUIT	647.2411.02				
A3	ED STEUERTEIL CONTROL CIRCUIT NUR VAR/ONLY MOD: 02 05	647.5310.02				
A3	ED STEUERTEIL CONTROL CIRCUIT NUR VAR/ONLY MOD: 04	647.5310.04				
					- ENDE -	
ROHDE & SCHWARZ		Äl	Datum Date	Schaltteilliste für Parts list for	Sachnummer Stock No.	Blatt Page
		05	0392	FK852P4 MOT.ABGEST. SELEKT FK852P4 MOTOR-TUNED FILT.	647.2011.01 SA	1-

Kennz. Comp.No.	Benennung Designation	Sachnummer Stock No.	Hersteller Manufacturer	Bezeichnung Designation	enthalten in contained in
.	ZUEH. STROML. /CIRC. DIAGR. 647.2011 S				
C100	ZM DREHKONDENSATOR VARIABLE CAPACITOR	647.2205			
M100	ZM MOTOR MOTOR	647.2392			
U1	BP H21A5 GABELLICHTSCHR LIGHT BARRIER	BP 092.9668	GEN.ELECTR	H21A5	
U2	BP H21A5 GABELLICHTSCHR LIGHT BARRIER	BP 092.9668	GEN.ELECTR	H21A5	
U3	BP H21A5 GABELLICHTSCHR LIGHT BARRIER	BP 092.9668	GEN.ELECTR	H21A5	
U4	BP H21A5 GABELLICHTSCHR LIGHT BARRIER	BP 092.9668	GEN.ELECTR	H21A5	
X30	BESTEHT AUS/CONSISTING OF BUCHSENLEISTE 647.5733 FEMALE CONN.STRIP 647.5733 KONTAKTEINSATZ FP458.0194 INSERT FP458.0194 CODIERSTIFT FP418.0041 CODING PIN FP418.0041				647.2392
X40	BESTEHT AUS/CONSISTING OF BUCHSENKOERPER 647.5740 SOCKET BODY 647.5740 EINSATZ FP458.0194 INSERT FP458.0194 CODIERSTIFT FP418.0041 CODING PIN FP418.0041				647.2386
					- ENDE -
ROHDE & SCHWARZ		Äl	Schaltteilliste für Parts list for		Sachnummer Stock No.
		Datum Date			Blatt Page
		04 0593	ZM DREHKO + GETRIEBE VARIABLE CAPACITOR + GEAR		647.2192.00 SA
					1-

Für diese Unterlage behalten wir uns alle Rechte vor

Kennz. Comp.No.	Benennung Designation	Sachnummer Stock No.	Hersteller Manufacturer	Bezeichnung Designation	enthalten in contained in
	VARIANTENERKL. / VERSIONS VAR 02 = GRUNDAUSFUEHRUNG MOD 02 = BASIC MODEL				
C10	CG 1NF+-0,5% 250V TKF MICA CAPACITOR	CG 023.1626	JAHRE	53-1/1000PF/0,5/250	
C11	CT 9,3PF NORMAL 0/U 4ST AIR-TYPE TRIMMER	CT 025.7215	TRONSER	10 1111 20011	
C12	CT 9,3PF NORMAL 0/U 4ST AIR-TYPE TRIMMER	CT 025.7215	TRONSER	10 1111 20011	
C13	CT 9,3PF NORMAL 0/U 4ST AIR-TYPE TRIMMER	CT 025.7215	TRONSER	10 1111 20011	
C20	CG 390PF+-1% 250V TKF MICA CAPACITOR	CG 023.1578	JAHRE	53-1/390PF/1/250	
C21	CT 9,3PF NORMAL 0/U 4ST AIR-TYPE TRIMMER	CT 025.7215	TRONSER	10 1111 20011	
C22	CT 9,3PF NORMAL 0/U 4ST AIR-TYPE TRIMMER	CT 025.7215	TRONSER	10 1111 20011	
C23	CT 9,3PF NORMAL 0/U 4ST AIR-TYPE TRIMMER	CT 025.7215	TRONSER	10 1111 20011	
C31	CT 9,3PF NORMAL 0/U 4ST AIR-TYPE TRIMMER	CT 025.7215	TRONSER	10 1111 20011	
C32	CT 9,3PF NORMAL 0/U 4ST AIR-TYPE TRIMMER	CT 025.7215	TRONSER	10 1111 20011	
C33	CT 9,3PF NORMAL 0/U 4ST AIR-TYPE TRIMMER	CT 025.7215	TRONSER	10 1111 20011	
C41	CT 9,3PF NORMAL 0/U 4ST AIR-TYPE TRIMMER	CT 025.7215	TRONSER	10 1111 20011	
C42	CT 9,3PF NORMAL 0/U 4ST AIR-TYPE TRIMMER	CT 025.7215	TRONSER	10 1111 20011	
C43	CT 9,3PF NORMAL 0/U 4ST AIR-TYPE TRIMMER	CT 025.7215	TRONSER	10 1111 20011	
C51	CT 9,3PF NORMAL 0/U 4ST AIR-TYPE TRIMMER	CT 025.7215	TRONSER	10 1111 20011	
C52	CT 9,3PF NORMAL 0/U 4ST AIR-TYPE TRIMMER	CT 025.7215	TRONSER	10 1111 20011	
C53	CT 9,3PF NORMAL 0/U 4ST AIR-TYPE TRIMMER	CT 025.7215	TRONSER	10 1111 20011	
C55	CC 10PF+-2,5%400V5NPO CAPACITOR	450.8196	VALVO	2222 654 10109	
C56	CC 10PF+-2,5%400V5NPO CAPACITOR	450.8196	VALVO	2222 654 10109	
C57	CC 10PF+-2,5%400V5NPO CAPACITOR	450.8196	VALVO	2222 654 10109	
C58	CC 4,3PF+-0,25PF5NPO CAPACITOR	450.6929	STETTNER	SDPL5;4,3PF/0,25NPO	
C59	CC 4,3PF+-0,25PF5NPO CAPACITOR	450.6929	STETTNER	SDPL5;4,3PF/0,25NPO	
C60	CC 4,3PF+-0,25PF5NPO CAPACITOR	450.6929	STETTNER	SDPL5;4,3PF/0,25NPO	
C61	CC 22NF+-10%50VK1200VIELS CAPACITOR	CC 060.2445	UNION CARB	CK05BX223K	
C62	CC 22NF+-10%50VK1200VIELS CAPACITOR	CC 060.2445	UNION CARB	CK05BX223K	
C63	CC 22NF+-10%50VK1200VIELS CAPACITOR	CC 060.2445	UNION CARB	CK05BX223K	
C64	CC 22NF+-10%50VK1200VIELS CAPACITOR	CC 060.2445	UNION CARB	CK05BX223K	
C65	CC 22NF+-10%50VK1200VIELS CAPACITOR	CC 060.2445	UNION CARB	CK05BX223K	
C66	CC 22NF+-10%50VK1200VIELS CAPACITOR	CC 060.2445	UNION CARB	CK05BX223K	
C67	CC 22NF+-10%50VK1200VIELS CAPACITOR	CC 060.2445	UNION CARB	CK05BX223K	
C68	CC 22NF+-10%50VK1200VIELS CAPACITOR	CC 060.2445	UNION CARB	CK05BX223K	
C69	CC 22NF+-10%50VK1200VIELS CAPACITOR	CC 060.2445	UNION CARB	CK05BX223K	
C71	CC 22NF+-10%50VK1200VIELS CAPACITOR	CC 060.2445	UNION CARB	CK05BX223K	
C72	CC 1NF+-10%200V5K1200VIEL CAPACITOR	CC 068.4047	UNION CARB	CK05BX102K	
C73	CC 100PF+- 5%100V NPO VIE CERAMIC CAPACITOR	CC 060.0771	UNIONCARB	C052C101J2G1CA	
C74	CG 3,3NF+-0,5% 250V TKG MICA CAPACITOR	CG 023.1684	JAHRE	53-2/3,3NF/0,5/250	
C78	CC 100NF+-10%50V5K1200VIE CAPACITOR	CC 084.5350	UNION CARB	CK05BX104K	

ROHDE & SCHWARZ	Äl	Datum Date	Schaltteilliste für Parts list for	Sachnummer Stock Nr.	Blatt Page
		08 1188	ED HF-TEIL RF CIRCUIT	647.2411.01 SA	1+

Für diese Unterlage behalten wir uns alle Rechte vor

Kennz. Comp.No	Benennung Designation	Sachnummer Stock No.	Hersteller Manufacturer	Bezeichnung Designation	enthalten in contained in
C79	CC 220NF+-10%50V7K1200VIE CERAMIC CAPACITOR	084.5515	UNION CARB	CK06BX224K	
C80	CC 220NF+-10%50V7K1200VIE CERAMIC CAPACITOR	084.5515	UNION CARB	CK06BX224K	
C81	CC 10NF+-10%100V5K1200VIE CERAMIC CAPACITOR	CC 068.4060	UNION CARB	CK05BX103K	
C82	CC 100NF+-10%50V5K1200VIE CAPACITOR	CC 084.5350	UNION CARB	CK05BX104K	
C83	CC 100NF+-10%50V5K1200VIE CAPACITOR	CC 084.5350	UNION CARB	CK05BX104K	
C85	CC 10PF+-0,25PF3X4NPO CAPACITOR	CC 087.6429	VALVO	2222 678 09109	
C87	CC 100NF+-10%50V5K1200VIE CAPACITOR	CC 084.5350	UNION CARB	CK05BX104K	
C88	CC 15PF+- 5%100V NPO VIEL CERAMIC CAPACITOR	CC 060.0671	UNIONCARB	C052C150J2G1CA	
C89	CC 15PF+- 5%100V NPO VIEL CERAMIC CAPACITOR	CC 060.0671	UNIONCARB	C052C150J2G1CA	
H1	SU UEBERSPANNUNGSABL. 150V ARRESTER 150V	SU 645.8412	SIEMENS	B1-C150/Q69-X157	
K4	SN GEPOLT 2XU 12V RELAY	645.6810	SDS	DS2E-DC12V	
K6	SN GEPOLT 2XU 12V RELAY	645.6810	SDS	DS2E-DC12V	
K11	SN 12V 2MAL 21 AG RELAY	647.5756	TAKAMISAWA	RY-12W-OH-K	
K12	SN 12V 2MAL 21 AG RELAY	647.5756	TAKAMISAWA	RY-12W-OH-K	
K13	SN 12V 2MAL 21 AG RELAY	647.5756	TAKAMISAWA	RY-12W-OH-K	
K21	SN 12V 2MAL 21 AG RELAY	647.5756	TAKAMISAWA	RY-12W-OH-K	
K22	SN 12V 2MAL 21 AG RELAY	647.5756	TAKAMISAWA	RY-12W-OH-K	
K23	SN 12V 2MAL 21 AG RELAY	647.5756	TAKAMISAWA	RY-12W-OH-K	
K31	SN 12V 2MAL 21 AG RELAY	647.5756	TAKAMISAWA	RY-12W-OH-K	
K32	SN 12V 2MAL 21 AG RELAY	647.5756	TAKAMISAWA	RY-12W-OH-K	
K33	SN 12V 2MAL 21 AG RELAY	647.5756	TAKAMISAWA	RY-12W-OH-K	
K41	SN 12V 2MAL 21 AG RELAY	647.5756	TAKAMISAWA	RY-12W-OH-K	
K42	SN 12V 2MAL 21 AG RELAY	647.5756	TAKAMISAWA	RY-12W-OH-K	
K43	SN 12V 2MAL 21 AG RELAY	647.5756	TAKAMISAWA	RY-12W-OH-K	
K51	SN 12V 2MAL 21 AG RELAY	647.5756	TAKAMISAWA	RY-12W-OH-K	
K52	SN 12V 2MAL 21 AG RELAY	647.5756	TAKAMISAWA	RY-12W-OH-K	
K53	SN 12V 2MAL 21 AG RELAY	647.5756	TAKAMISAWA	RY-12W-OH-K	
L1	LD 10 UH 10% 3R3 144 MA CHOKE	LD 026.4184	DELEVAN	DROSSEL1025-44	
L3	LD SPULE	647.2440			
L4	LD SPULE	647.2440			
L5	LD 100 UH10%8,000HMO,084A CHOKE	LD 067.3101	DELEVAN	DROSSEL1025-68	
L6	LD SPULE	647.5804			
L10	LL SPULE	647.2463			
L11	LD SPULE COIL	617.9301			
L12	LD SPULE COIL	617.9318			
L13	LD SPULE COIL	617.9301			
L20	LL SPULE	647.2470			
L21	LD SPULE COIL	617.9324			
L22	LD SPULE COIL	617.9330			
L23	LD SPULE COIL	617.9324			

647.5033

647.5033

ROHDE & SCHWARZ	ÄI	Datum Date	Schaltteilliste für Parts list for	Sachnummer Stock Nr.	Blatt Page
	08.1188				

Für diese Unterlage behalten wir uns alle Rechte vor

Kennz. Comp.No.	Benennung Designation	Sachnummer Stock No.	Hersteller Manufacturer	Bezeichnung Designation	enthalten in contained in
L31	LD SPULE COIL	617.9347			
L32	LD SPULE COIL	617.9353			
L33	LD SPULE COIL	617.9347			
L41	LD SPULE COIL	617.9360			
L42	LD SPULE COIL	617.9376			
L43	LD SPULE COIL	617.9360			
L51	LD SPULE COIL	617.9382			
L52	LD SPULE COIL	617.9399			
L53	LD SPULE COIL	617.9382			
R1	RL 0,35W 56,2 OHM+-1%TK50	RL 082.9571	DRALORIC	SMA0207/56,20HM-F-D	
R5	RESISTOR				
R6	RL 0,35W 182 OHM+-1%TK50	RL 083.0010	DRALORIC	SMA0207/1820HM-F-D	
R7	RESISTOR				
R7	RL 0,35W 10,0KOHM+-1%TK50	RL 083.1297	DRALORIC	SMA0207/10K-F-D	
R8	RESISTOR				
R8	RL 0,35W 182 OHM+-1%TK50	RL 083.0010	DRALORIC	SMA0207/1820HM-F-D	
R10	RESISTOR				
R10	RL 0,35W 10,0KOHM+-1%TK50	RL 083.1297	DRALORIC	SMA0207/10K-F-D	
R11	RESISTOR				
R11	RL 0,35W 100KOHM+-1%TK50	RL 082.1764	DRALORIC	SMA0207/100K-F-C	
R12	RESISTOR				
R12	RL 0,35W 150 OHM+-1%TK50	RL 082.9942	DRALORIC	SMA0207/1500HM-F-D	
R13	RESISTOR				
R13	RL 0,35W 15,0KOHM+-1%TK50	RL 083.1400	DRALORIC	SMA0207/15K-F-D	
R14	RESISTOR				
R14	RL 0,35W 33,2 OHM+-1%TK50	RL 082.9359	DRALORIC	SMA0207/33,20HM-F-D	
R15	RESISTOR				
R15	RL 0,35W 100 OHM+-1%TK50	RL 082.6543	DRALORIC	SMA0207/100/HM-F-D	
R16	METALFILM-RESISTOR				
R16	RL 0,35W 274 OHM+-1%TK50	RL 083.0178	DRALORIC	SMA0207/2740HM-F-D	
R17	RESISTOR				
R17	RL 0,35W 1,21KOHM+-1%TK50	RL 083.0655	DRALORIC	SMA0207/1,21K-F-D	
R18	RESISTOR				
R18	RL 0,35W 4,75KOHM+-1%TK50	RL 083.1097	DRALORIC	SMA0207/4,75K-F-D	
R21	RESISTOR				
R21	RL 0,35W 10,0 OHM+-1%TK50	RL 082.8852	DRALORIC	SMA0207/100HM-F-D	
R22	RESISTOR				
R22	RL 0,35W 47,5 OHM+-1%TK50	RL 082.9507	DRALORIC	SMA0207/47,50HM-F-D	
R23	RESISTOR				
R23	RL 0,35W 47,5 OHM+-1%TK50	RL 082.9507	DRALORIC	SMA0207/47,50HM-F-D	
V1	AD 1N4448 75V OA15 UDI	AD 012.0700	TEXAS INST	1N4448 GEGURTET	
V3	DIODE				
V4	AE BZX79/C3V3 0,5W ZDI	AE 012.2390	ITT	ZPD3,3	
V5	ZENER DIODE				
V5	AD 1N4448 75V OA15 UDI	AD 012.0700	TEXAS INST	1N4448 GEGURTET	
V6	DIODE				
V6	AD 1N4448 75V OA15 UDI	AD 012.0700	TEXAS INST	1N4448 GEGURTET	
V7	DIODE				
V7	AE BZX55/C2V7 0,5W ZDI	AE 086.8228	AEG-TELEF.	BZX55/C2V7	
V8	ZENER DIODE				
V8	AE ZX3,9 5% 10W ZDI#	AE 012.3274	INTERMETAL	ZX3,9	
V9	ZENER DIODE				
V9	AG 1N5804 GL 100V 2A5	AG 453.4762	UNITRODE	1N5804	
V10	RECTIFIER				
V10	AG 1N5804 GL 100V 2A5	AG 453.4762	UNITRODE	1N5804	
V12	RECTIFIER				
V12	AK BFW16A N 40V 150MA	AK 010.4644	VALVO	BFW16A	
W2	TRANSISTOR				
W2	DX HF-KABEL	647.2492			
W11	RF CABLE				
W11	DX HF-KABEL	647.5579			
W12	RF CABLE				
W12	DX HF-KABEL	647.5585			
W12	RF CABLE				

ROHDE & SCHWARZ	ÄI	Datum Date	Schaltteilliste für Parts list for	Sachnummer Stock Nr.	Blatt Page
	08	1188	ED HF-TEIL RF CIRCUIT	647.2411.01 SA	3+

Für diese Unterlage behalten wir uns alle Rechte vor

Kennz. Comp.No.	Benennung Designation	Sachnummer Stock No.	Hersteller Manufacturer	Bezeichnung Designation	enthalten in contained in	
X10	FP BUCHSENLEISTE 13POL. SOCKET CONNECTOR	FP 510.1391	BERG	76323-213	- ENDE -	
X13	FP STIFTLAISTE 36POL. CONNECTOR 4-POLIG	580.6034	BINDER	11-0169-00-36		
X14	FP KURZSCHLUSSBUCHSE SHORTING PLUG	FP 491.7042	PK	452-70302		
X53	FJ EINBAUSTECKER SYST.SMB FIXED CONNECTOR	FJ 063.5116	ROSENBERG	59S601-200D2		
X55	FJ EINBAUSTECKER SYST.SMB FIXED CONNECTOR	FJ 063.5116	ROSENBERG	59S601-200D2		
- ENDE -						
ROHDE & SCHWARZ		Ä	Datum Date	Schalttailliste für Parts list for	Sachnummer Stock Nr.	Blatt Page
		08	1188	ED HF-TEIL RF CIRCUIT	647.2411.01 SA	4-

Für diese Unterlage behalten wir uns alle Rechte vor

Kennz. Comp.No.	Benennung Designation	Sachnummer Stock No.	Hersteller Manufacturer	Bezeichnung Designation	enthalten in contained in
.	VARIANTENERKL. / VERSIONS VAR 02 = GRUNDAUSFUEHRUNG MOD.02 = BASIC MODEL VAR 04 = AUSF.F.SK859L2 MOD 04 = VERS.F.SK859L2				
C1	CE 15 UF+-20%50V 8X18TA ELECTROLYTIC CAPACITOR	CE 006.3430	ITT	TAEK04320228215	
C2	CE 15 UF+-20%50V 8X18TA ELECTROLYTIC CAPACITOR	CE 006.3430	ITT	TAEK04320228215	
C3	CC 100NF+-10%50V5K1200VIE CAPACITOR	CC 084.5350	UNION CARB	CK05BX104K	
C4	CC 100NF+-10%50V5K1200VIE CAPACITOR	CC 084.5350	UNION CARB	CK05BX104K	
C5	CE 4,7UF+-20% 100V 6X13FL ELECTROLYTIC CAPACITOR	CE 467.9010	TANSITOR	M39006/22-0184	
..8 C10	CC 1NF+-10%200V5K1200VIEL CAPACITOR	CC 068.4047	UNION CARB	CK05BX102K	
C11	CC 1NF+-10%200V5K1200VIEL CAPACITOR	CC 068.4047	UNION CARB	CK05BX102K	
C12	CC 1NF+-10%200V5K1200VIEL CAPACITOR	CC 068.4047	UNION CARB	CK05BX102K	
C13	CC 1NF+-10%200V5K1200VIEL CAPACITOR	CC 068.4047	UNION CARB	CK05BX102K	
C14	CC 1NF+-10%200V5K1200VIEL CAPACITOR	CC 068.4047	UNION CARB	CK05BX102K	
C15	CC 1NF+-10%200V5K1200VIEL CAPACITOR	CC 068.4047	UNION CARB	CK05BX102K	
C17	CC 1NF+-10%200V5K1200VIEL CAPACITOR	CC 068.4047	UNION CARB	CK05BX102K	
C18	CC 1NF+-10%200V5K1200VIEL CAPACITOR	CC 068.4047	UNION CARB	CK05BX102K	
C19	CC 1NF+-10%200V5K1200VIEL CAPACITOR	CC 068.4047	UNION CARB	CK05BX102K	
C20	CC 1NF+-10%200V5K1200VIEL CAPACITOR	CC 068.4047	UNION CARB	CK05BX102K	
C21	CC 1NF+-10%200V5K1200VIEL CAPACITOR	CC 068.4047	UNION CARB	CK05BX102K	
C22	CC 1NF+-10%200V5K1200VIEL CAPACITOR	CC 068.4047	UNION CARB	CK05BX102K	
C23	CC 1NF+-10%200V5K1200VIEL CAPACITOR	CC 068.4047	UNION CARB	CK05BX102K	
C24	CC 1NF+-10%200V5K1200VIEL CAPACITOR	CC 068.4047	UNION CARB	CK05BX102K	
C25	CC 1NF+-10%200V5K1200VIEL CAPACITOR	CC 068.4047	UNION CARB	CK05BX102K	
C26	CC 1NF+-10%200V5K1200VIEL CAPACITOR	CC 068.4047	UNION CARB	CK05BX102K	
C27	CC 1NF+-10%200V5K1200VIEL CAPACITOR	CC 068.4047	UNION CARB	CK05BX102K	
C28	CC 1NF+-10%200V5K1200VIEL CAPACITOR	CC 068.4047	UNION CARB	CK05BX102K	
C29	CC 1NF+-10%200V5K1200VIEL CAPACITOR	CC 068.4047	UNION CARB	CK05BX102K	
C30	CC 1NF+-10%200V5K1200VIEL CAPACITOR	CC 068.4047	UNION CARB	CK05BX102K	
C32	CC 1UF+-10%50V7K1200VIEL CAPACITOR	084.5538	UNION CARB	CK06BX105K	
C33	CC 1NF+-10%200V5K1200VIEL CAPACITOR	CC 068.4047	UNION CARB	CK05BX102K	
C40	CC 22NF+-10%50VK1200VIELS CAPACITOR	CC 060.2445	UNION CARB	CK05BX223K	
C42	CC 22NF+-10%50VK1200VIELS CAPACITOR	CC 060.2445	UNION CARB	CK05BX223K	
C43	CC 22NF+-10%50VK1200VIELS CAPACITOR	CC 060.2445	UNION CARB	CK05BX223K	
C44	CC 22NF+-10%50VK1200VIELS CAPACITOR	CC 060.2445	UNION CARB	CK05BX223K	
C52	CC 120PF+- 5%100V NPO VIE CERAMIC CAPACITOR	CC 060.0788	UNIONCARB	C052C121J2G1CA	
C60	CC 100NF+-10%50V5K1200VIE CAPACITOR	CC 084.5350	UNION CARB	CK05BX104K	
C61	CC 10NF+-10%100V5K1200VIE CERAMIC CAPACITOR	CC 068.4060	UNION CARB	CK05BX103K	
C62	CC 10NF+-10%100V5K1200VIE CERAMIC CAPACITOR	CC 068.4060	UNION CARB	CK05BX103K	
C63	CC 10NF+-10%100V5K1200VIE CERAMIC CAPACITOR	CC 068.4060	UNION CARB	CK05BX103K	

ROHDE & SCHWARZ

Äl Datum
Date
16 0392

Schaltteilliste für
Parts list for

**ED STEUERTEIL
CONTROL CIRCUIT**

Sachnummer
Stock No.

647.5310.01 SA

Blatt
Page

1+

Für diese Unterlage behalten wir uns alle Rechte vor

Kennz. Comp.No.	Benennung Designation	Sachnummer Stock No.	Hersteller Manufacturer	Bezeichnung Designation	enthalten in contained in
C64	CC 68PF+- 5%100V NPO VIEL CERAMIC CAPACITOR	CC 060.0759	UNIONCARB	C052C680J2F1CA	
C65	CC 180PF+- 5%100V NPO VIE CERAMIC CAPACITOR	CC 060.0807	UNIONCARB	C052C181J2G1CA	
C66	CC 2,4PF+-0,25PF5NPO CAPACITOR	450.6887	STETTNER	SDPL5;2,4PF/0,25NPO	
C67	CE 47 UF+-20% 6V 7X 5X11 ELECTROLYTIC CAPACITOR NUR VAR/ONLY MOD: 04	CE 022.8040	ROEDERSTEI	ETR 3 47/6,3 20%	
D1	BL MC14584BAL 6XSCH.TRIGG SCHMITT TRIGGER	522.4549	MOTOROLA	MC1458BALD	
. .3					
D4	BL MM54C906J 6XN-CH.BUFF N-CHANNEL BUFFER 0D	418.0264	NSC	MM54C906J	
D5	BL MM54C906J 6XN-CH.BUFF N-CHANNEL BUFFER 0D	418.0264	NSC	MM54C906J	
D10	BL CD4013BF 2XD FLIPFL FLIPFLOP	086.8034	RCA	CD4013BF	
D12	BL MC14538BAL 2X MONOFLOP MONOSTABLE MULTIVIBRATOR	526.5427	MOTOROLA	MC14538BAL	
H1	SU 90V 5KA SPARK-GAP VOLTAGE DISCHAR	SU 065.9219	SIEMENS	B1-C90/20 Q69-X184	
K1	SN GEPOLT 2XU 12V RELAY	645.6810	SDS	DS2E-DC12V	
K2	SN GEPOLT 2XU 12V RELAY	645.6810	SDS	DS2E-DC12V	
K5	SN GEPOLT 2XU 12V RELAY	645.6810	SDS	DS2E-DC12V	
K7	SN GEPOLT 12V 2A+2R RELAY	SN 290.9085	SDS	S2-12V GEHAEUSE SCHW	
L1	LL SPULE COIL	647.5785			
L2	LL SPULE COIL	647.5791			
L3	LD SPULE	647.5827			
N6	BO LM139J 4X COMPAR COMPARATOR	BO 455.2873	NAT. SEMIC	LM139J	
N7	AK MHQ2907 4XP TR.ARRAY TRANSISTOR ARRAY	455.3992	MOTOROLA	MHQ2907	
. .9					
N11	BO LM139J 4X COMPAR COMPARATOR	BO 455.2873	NAT. SEMIC	LM139J	
R1	RN 3X4,7KOHM+-2%SIL6 H5 RESISTOR NETWORK	647.5833	BOURNS	4306R-102-472	
. .6					
R22	RN 5X100KOHM+-2%SIL 6 H5 RESISTOR NETWORK	RN 099.2681	BOURNS	4306R-101-104	
R28	RN 7X100KOHM+-2%SIL 8 H5 RESISTOR NETWORK	RN 540.5737	BOURNS	4308R-101-104	
R29	RN 7X100KOHM+-2%SIL 8 H5 RESISTOR NETWORK	RN 540.5737	BOURNS	4308R-101-104	
R40	RL 0,60W 22,1KOHM+-1%TK50 RESISTOR	RL 083.1545	DRALORIC	SMA/207/22,1K-F-C	
R41	RL 0,60W 3,92KOHM+-1%TK50 RESISTOR	RL 083.1039	RESISTA	MK2	
R42	RD 2.4W 0,68 OHM+-1% WIRE-WOUND RESISTOR	RD 087.5051	SAGE	1200S0,680HM+1%	
R43	RD 5W 4,7 OHM+-3% GEH. WIREWOUND RESISTOR	647.5610	DALE	RH-5 4,70HM 3%	
R44	RL 0,60W 1,21KOHM+-1%TK50 RESISTOR	RL 083.0655	DRALORIC	SMA0207/1,21K-F-D	
. .47					
R49	RL 0,60W 121 OHM+-1%TK50 RESISTOR	RL 082.9859	DRALORIC	SMA0207/1210HM-F-D	
R50	RL 0,60W 221 OHM+-1%TK50 RESISTOR	RL 083.0084	DRALORIC	SMA0207/2210HM-F-D	
. .52					
R53	RL 0,60W 6,81KOHM+-1%TK50 RESISTOR	RL 082.2560	DRALORIC	SMA 0207/6,81K-F-C	
. .56					
R57	RL 0,60W 10,0KOHM+-1%TK50 RESISTOR	RL 083.1297	DRALORIC	SMA0207/10K-F-D	
. .60					
R61	RL 0,60W 22,1KOHM+-1%TK50 RESISTOR	RL 083.1545	DRALORIC	SMA/207/22,1K-F-C	
. .66					
R67	RL 0,60W 3,92KOHM+-1%TK50 RESISTOR	RL 083.1039	RESISTA	MK2	
. .70					
R71	RL 0,60W 10,0KOHM+-1%TK50 RESISTOR	RL 083.1297	DRALORIC	SMA0207/10K-F-D	
. .79					

ROHDE & SCHWARZ	Äl	Datum Date	Schaltteilliste für Parts list for	Sachnummer Stock No.	Blatt Page
	16	0392	ED STEUERTEIL CONTROL CIRCUIT	647.5310.01 SA	2+

Für diese Unterlage behalten wir uns alle Rechte vor

Kennz. Comp.No.	Benennung Designation	Sachnummer Stock No.	Hersteller Manufacturer	Bezeichnung Designation	enthalten in contained in
R80 ..88	RL 0,60W 22,1KOHM+-1%TK50 RESISTOR	RL 083.1545	DRALORIC	SMA/207/22,1K-F-C	
R91	RL 0,60W 2,21KOHM+-1%TK50 RESISTOR	RL 082.2477	DRALORIC	SMA 0207/2,21K-F-C	
R92	RL 0,60W 47,5KOHM+-1%TK50 RESISTOR	RL 083.1800	DRALORIC	SMA/207/47,5K-F-C	
R93	RL 0,60W 2,21KOHM+-1%TK50 RESISTOR	RL 082.2477	DRALORIC	SMA 0207/2,21K-F-C	
R94	RL 0,60W 47,5KOHM+-1%TK50 RESISTOR	RL 083.1800	DRALORIC	SMA/207/47,5K-F-C	
R96	RL 0,60W1,30MOHM+-1%TK50 METALFILMRESISTOR	RL 099.8121	RESISTA	MK2.1,30MOHM 1% TK50	
R97	RL 0,60W 10,0KOHM+-1%TK50 RESISTOR	RL 083.1297	DRALORIC	SMA0207/10K-F-D	
R98	RL 0,60W 221 KOHM+-1%TK50 RESISTOR	RL 083.2270	DRALORIC	SMA0207/221K-F-C	
R99	RL 0,60W 2,21KOHM+-1%TK50 RESISTOR	RL 082.2477	DRALORIC	SMA 0207/2,21K-F-C	
R100	RL 0,60W2,21MOHM+-1%TK50 METALFILMRESISTOR	RL 099.8173	RESISTA	MK2 2,21MOHM 1% TK50	
R101	RL 0,60W 47,5KOHM+-1%TK50 RESISTOR	RL 083.1800	DRALORIC	SMA/207/47,5K-F-C	
R102	RL 0,60W 100 OHM+-1%TK50 RESISTOR	RL 082.6543	DRALORIC	SMA0207/100/HM-F-D	
R110	RL 0,60W 182 OHM+-1%TK50 RESISTOR	RL 083.0010	DRALORIC	SMA0207/182OHM-F-D	
R112	RL 0,60W 182 OHM+-1%TK50 RESISTOR	RL 083.0010	DRALORIC	SMA0207/182OHM-F-D	
R113	RL 0,60W 182 OHM+-1%TK50 RESISTOR	RL 083.0010	DRALORIC	SMA0207/182OHM-F-D	
R114	RL 0,60W 182 OHM+-1%TK50 RESISTOR	RL 083.0010	DRALORIC	SMA0207/182OHM-F-D	
R132	RL 0,60W 22,1KOHM+-1%TK50 RESISTOR	RL 083.1545	DRALORIC	SMA/207/22,1K-F-C	
R140 ..143	RL 0,60W 10,0KOHM+-1%TK50 RESISTOR	RL 083.1297	DRALORIC	SMA0207/10K-F-D	
R145	RL 0,60W 22,1KOHM+-1%TK50 RESISTOR	RL 083.1545	DRALORIC	SMA/207/22,1K-F-C	
R146	RL 0,60W 47,5KOHM+-1%TK50 RESISTOR	RL 083.1800	DRALORIC	SMA/207/47,5K-F-C	
R147	RL 0,60W 221 KOHM+-1%TK50 RESISTOR	RL 083.2270	DRALORIC	SMA0207/221K-F-C	
R148	RL 0,60W6,81 OHM+-1%TK50 METALFILMRESISTOR	RL 099.8067	RESISTA	MK2 6,81 OHM 1% TK50	
R149	RL 0,60W 47,5 OHM+-1%TK50 RESISTOR	RL 082.9507	DRALORIC	SMA0207/47,5OHM-F-D	
R150	RL 0,60W 47,5 OHM+-1%TK50 RESISTOR	RL 082.9507	DRALORIC	SMA0207/47,5OHM-F-D	
R151	RL 0,60W 2,74KOHM+-1%TK50 RESISTOR	RL 083.0926	DRALORIC	SMA0207/2,74K-F-D	
R152	RL 0,40W 100 OHM+-1%TK50 DEPOS.-CARBON RESISTOR NUR VAR/ONLY MOD: 04	RL 092.1321	RESISTA	MK1 100OHM 1% TK50	
V1	AE BZX85/C6V2 1,3W ZDI ZENER DIODE	AE 092.8249	THOMSON	BZX85/C6V2	
V2	AE BZX85/C18 1,3W ZDI ZENER DIODE	AE 092.8310	THOMSON	BZX85/C18	
V7 ..11	AD 1N4448 75V UDI DIODE	AD 012.0700	TEXAS INST	1N4448 GEGURTET	
V13 ..16	AD 1N4448 75V UDI DIODE	AD 012.0700	TEXAS INST	1N4448 GEGURTET	
V17	AD 1N4448 75V UDI DIODE	AD 012.0700	TEXAS INST	1N4448 GEGURTET	
V19	AE 5082-2800 SCHOTTKY DIODE	AE 012.9066	HEWLETT-P.	5082-2800	
V20 ..23	AE BZX85/C75 1,3W ZDI ZENER DIODE	AE 092.8449	THOMSON	BZX85/C75	
V25 ..27	AD 1N4448 75V UDI DIODE	AD 012.0700	TEXAS INST	1N4448 GEGURTET	
V33 ..36	AG 1N4007 GL1000V 1A0 RECTIFIER	AG 013.0310	AEG-TELEF	1N4007	
V41	AL BDX34B PNP 80V DARL TRANSISTOR	AL 092.9339	RCA	BDX34B	
V42 ..45	AL BDX33B NPN 80V DARL TRANSISTOR	AL 092.9322	RCA	BDX33B	
V50 ..54	AD 1N4448 75V UDI DIODE	AD 012.0700	TEXAS INST	1N4448 GEGURTET	

ROHDE & SCHWARZ	Äl	Datum Date	Schaltteilliste für Parts list for	Sachnummer Stock No.	Blatt Page
	16	0392	ED STEUERTEIL CONTROL CIRCUIT	647.5310.01 SA	3+

Für diese Unterlage behalten wir uns alle Rechte vor

Kennz. Comp.No.	Benennung Designation	Sachnummer Stock No.	Hersteller Manufacturer	Bezeichnung Designation	enthalten in contained in
X10	FP STIFTLISTE 36P.R2,54 PIN CONNECTOR	FP 230.2103	BINDER	742-5-11-0223-00-36	
X11	FJ EINBAUSTECKER F.GS SMB PLUG	FJ 063.5168	ROSENBERGE	59S 101-400D2	
X12	FJ EINBAUSTECKER F.GS SMB PLUG	FJ 063.5168	ROSENBERGE	59S 101-400D2	
X30	FP WINKELVERBINDER 10POL ANGLE PIN CONNECTOR	FP 540.5743	BERG	75789-101-10	
X40	FP WINKELVERBINDER 20POL ANGLE PIN CONNECTOR	FP 540.5750	BERG	75789-101-20	
X50	FP STIFTLISTE 36P.R2,54 CONNECTOR	580.6034	BINDER	11-0169-00-36	
X51	FP STECKERLEISTE 64POL. 64-PIN INSERT	FP 565.1429	ERNI	STV-P-64-M-AB VA 5MM	
X52	FJ EINBAUSTECKER SYST.SMB FIXED CONNECTOR	FJ 063.5116	SUHNER	22SMB-50-0-2 ZU 100	
X54	FJ EINBAUSTECKER SYST.SMB FIXED CONNECTOR	FJ 063.5116	SUHNER	22SMB-50-0-2 ZU 100	
X56	FJ EINBAUSTECKER SYST.SMB FIXED CONNECTOR	FJ 063.5116	SUHNER	22SMB-50-0-2 ZU 100	
					- ENDE -
ROHDE & SCHWARZ		Äl	Schaltteilliste für Parts list for		Sachnummer Stock No.
		Datum Date			
		16 0392	ED STEUERTEIL CONTROL CIRCUIT		647.5310.01 SA
					4-



ROHDE & SCHWARZ

Communications Division

Repair Manual

LOW - PASS FILTER

FK 852P5

647.3518

©

Copying of this document as well as any other utilization and communication of its content are only admissible with the permission of the originator or other authorized persons.

Any disregard will be prosecuted and is subject to restitution (UrhG, UWG, BGB). For the case a patent is issued or the design is officially registered all rights are reserved.

ROHDE & SCHWARZ GmbH & Co. KG · D-81671 München · Mühldorfstr. 15 · Tel. (089) 4129-0 Int. + 4989 4129-0

Telefax (089) 4129-2164 Int. + 4989 4129-2164

**Printed in the Federal Republic of Germany · Subject to change · Data without tolerances: order of magnitude only
0694**

LOW - PASS FILTER
 FK 852P5
 Repair Manual
 Part 0: List of Contents

- 0.1 -

LIST OF CONTENTS

1.	Characteristics	(see User Manual).	1.1
<hr/>			
2.	Preparation for Use and Operation	(see User Manual).	2.1
<hr/>			
3.	Maintenance	(see User Manual).	3.1
<hr/>			
4.	Troubleshooting	(see User Manual).	4.1
<hr/>			
5.	Description of Function		5.1
<hr/>			
5.1	Signal Path for Reception		5.1
5.2	Signal Path for Reception of High Level HF Signals (> 5 V)		5.1
5.3	Signal Path for Reception of Frequencies below 400 kHz		5.1
5.4	HF Gain Control		5.1
5.5	Signal Path for Transmission		5.1
5.6	Control of the Low-Pass Filter		5.2
5.7	Test Operation		5.2
<hr/>			
6.	Repair		6.1
<hr/>			
6.1	Preliminary Remarks		6.1
6.1.1	Troubleshooting Instructions		6.1
6.1.2	Restoring the Nominal Characteristics		6.2
6.1.3	Spare Parts		6.2
6.1.4	Important User Information		6.2
6.2	Test Equipment		6.2
6.2.1	Test Equipment List		6.3

(Continuation)---

LOW - PASS FILTER
 FK 852P5
 Repair Manual
 Part 0: List of Contents

- 0.2 -

(Continuation) List of Contents

6.3	Troubleshooting Flowchart	6.3
6.3.1	General	6.3
6.4	Measurements, Alignments and Functional Checks	6.9
6.4.1	Adjustment of the Automatic Gain Response	6.9
6.4.2	Functional Test of the Gain	6.9
6.5	Replacement of Components	6.10
6.6	Final Test of the Low-Pass Filter	6.10
6.6.1	Current Consumption	6.10
6.6.2	Stabilized Voltages	6.10
6.6.3	Gain Test	6.10
6.6.4	Selection Test	6.11
6.6.5	Intermodulation Test	6.11
6.6.6	Test of the Noise Figure	6.11
6.6.7	Test of the Automatic Gain Control	6.12
6.6.8	Test of the Overvoltage Protection	6.12
6.7	External Interfaces	6.13

LIST OF FIGURES

Fig.	Title	Page
5.1	Low-Pass Filter FK 852P5, Block Diagram	5.3
6.1	Low-Pass Filter FK 852P5, Troubleshooting Flowchart	6.4
6.2	Test Set-up for the Intermodulation Test	6.15
6.3	Test Set-up for the Noise Figure Test	6.17
6.4	Test Set-up for the Overvoltage Protection Test	6.19

Appendix *****

Circuit Diagram	647.3518S
Electrical Parts List	647.3518SA
Electrical Parts List	647.3530SA
Component Layout	647.3530, page 2 and 3

LOW - PASS FILTER
FK 852P5

Repair Manual
 Part 5: Characteristics

- 5.1 -

5. Description of Function

(See circuit diagram 647.3518S for 5.1 to 5.7)

5.1 Signal Path for Reception

In reception, the HF signal from the antenna is fed via connector X52 to an input low-pass filter which blocks frequencies above 100 MHz from the signal path.

Subsequently the signal is fed via relay contacts K35 and K31 to the Cauer band-pass operating in the frequency range of 0.4 to 30 MHz and from there to the 9-dB amplifier V25, functioning in common base circuit.

Losses of signal level caused by the preceding selection unit are compensated for by this amplifier. Via relay contacts K32 (6.4) and K32 (13.11) the signal is fed to connector X55 from where it is routed to the Tx/Rx Section GX 852P1.

The fixed-voltage regulators N5 and N6 serve to stabilise the working point of amplifier V25. Further they generally improve the power supply of the amplifier V25.

5.2 Signal Path for Reception of High Level HF Signals (> 5 V)

Following the input filter consisting of C90, C91 and L30 the HF reception signal is fed via a fullwave rectifier circuit to the input pins 6 and 7 of comparator N4. Pin 8 of N4 is used for input of the reference voltage.

For input voltages > 5 V at connector X52 the output of N4 at pin 14 is on positive potential. Thereby relay K36 deenergizes and the associated contacts K36 switch the 40-dB attenuator consisting of R123 and R124 into circuit.

In this way the low-pass filter and subsequent following modules are protected against possible destruction due to overvoltage.

For repair purposes test point MP14 has been provided which is located at pin 14 of the comparator N4.

5.3 Signal Path for Reception of Frequencies below 400 kHz

For reception of frequencies below 400 kHz the band-pass filter and amplifier V25 are bypassed by contacts K31 (4.8) and K32 (8.4).

5.4 HF Gain Control

The automatic gain control (AGC) voltage from the Tx/Rx Section GX 852P1 is applied via connector X51.a21 to pin 6 of amplifier N1. The reference voltage, adjustable by means of potentiometer R100, is fed to amplifier N1.1 which amplifies the control voltage and feeds it to the PIN diodes V60 and V61. These PIN diodes conduct more or less depending upon the value of the control voltage.

The HF reception signal that is applied to these PIN diodes is thereby attenuated by up to 15 dB.

5.5 Signal Path for Transmission

In transmission the HF signal from the Tx/Rx Section GX 852P1 is just routed through the low-pass filter. The signal arrives at connector X53. Via cable W1 it is fed to connector X54 and then to the HF amplifier.

LOW - PASS FILTER
FK 852P5Repair Manual
Part 5: Characteristics

- 5.2 -

5.6 Control of the Low-Pass
Filter

The control of the low-pass filter is effected by means of data and strobe signals from the Processor GS 852P1. These control signals arrive at connector X51 and are subsequently buffered intermediately in the D-type flipflops D1 and D3. From there they are transferred to the level converter D9 that triggers the driving transistors for the relays. In the test mode D9 triggers the comparator N4.

5.7 Test Operation

In test operation BITE signals generated by the Processor GS 852P1 drive the data inputs X51.a10, a.11 and the strobe 9 input X51.a9 of the low-pass filter. The memory output D9.1 switches a low level to comparator N4, pin 12. Thereby comparator N4 output at pin 14 is set to +15 VDC. Subsequently relay K36 is deenergized and its associated contacts switch the 40-dB attenuator consisting of R123 and R124 into circuit for level matching.

The memory output D9.2 drives transistor V12 which in turn energizes relay K35. Relay contact K35 (8.4) switches off the reception antenna from the following signal path. Via relay contact K35 (9.13) the signal path is now free for the test signal.

Memory output D9.2 and transistor V12 additionally energize relay K34. Thereby a 20-dB attenuator consisting of R18 to R20 is switched into circuit for further level matching.

The test signal consisting of a 900-kHz line spectrum with a bandwidth of 30 MHz is fed as a simulated antenna signal to the input of the Low-Pass Filter FK 852P5 at connector X56. From there the test signal is routed via the 40-dB attenuator consisting of R123, R124 and R125 to the Caer band-pass filter.

Next the test signal is routed via the 9-dB amplifier V25, the 20-dB attenuator consisting of R18, R19 and R20 to connector X55. From X55 the test signal is routed to the Tx/Rx Section GX 852P1 where it is used to test the sensitivity of the HF receiver.

LOW - PASS FILTER
FK 852P5

Repair Manual
Part 6: Repair

- 6.1 -

6. Repair

See circuit diagram, parts list and components layout in the appendix to this repair manual (list on page 0.2).

6.1 Preliminary Remarks

The repair of the Low-Pass Filter FK 852P5 consists of troubleshooting and fault elimination, of measurements, alignments and functional checks, of replacing assemblies and components as well as of a final inspection.

All the information required for repairing the filter down to component level is given in this section.

For all alignment work and measurements the filter has to be supplied with the operating voltages given in the circuit diagram 647.3518S.

All RF measurements on the filter have to be performed with the covers screwed down in place; if necessary, a special test cover has to be produced for this purpose.

With RF measurements ensure that cables and connections are of the right characteristic impedance and that the connecting leads are as short as possible.

Among the components incorporated in the low-pass filter there are MOS, MOSFET and CMOS devices. Devices of this kind are extremely sensitive to high extraneous voltages. Static discharge can produce very high voltage spikes, which are capable of destroying these devices.

For this reason, when work is being carried out in the vicinity of these devices, i.e. unless a special CMOS work station is available, the following minimum requirements should be observed:

- conductive bench and floor coverings
- chair or stool with conductive coverings
- grounded, metallic work surface and conductive wrist-straps with a resistance of > 200 kohms, < 1 Mohm plus an insulated lead and plug
- soldering irons with safety grounding
- all conductive surfaces, wrist-straps and work surfaces must be interconnected by insulated leads
- supply voltages must be disconnected before soldering is being performed

In general:

When performing any electrical or mechanical repairs on the Low-Pass Filter FK 852P5, only disassemble the unit to the extent necessary for the performing of these repairs.

6.1.1 Troubleshooting Instructions

Any fault that occurs should be localized with the aid of the troubleshooting flowchart given in 6.3.

**LOW - PASS FILTER
FK 852P5**

Repair Manual
Part 6: Repair

- 6.2 -

6.1.2 Restoring the Nominal Characteristics

Any component that is definitely proved to be defective - through use of the troubleshooting flowchart or by performing the alignments, measurements and functional checks - should only be replaced by a component that meets the specifications given in the parts list in the appendix to this repair manual.

Only in this way can the technical data be guaranteed that are given in part 1 of the user manual.

Once components have been replaced, it is absolutely essential that the final test of the low-pass filter, detailed in chapter 6.6 be performed.

6.1.3 Spare Parts

All components and assemblies are subjected to strict quality control before they are built into the low-pass filter.

For components from outside suppliers, e.g. for resistors, capacitors, diodes transistors and integrated through to highly integrated circuits, R&S have set down their own delivery specifications for the purpose of ensuring maximum reliability. For this reason we recommend that only original spare parts be used, for replacing defective components.

When ordering a spare part, please state the following:

Type, ordering code and serial number of equipment, Ident. number of the parts list and designation plus stock number of the component concerned.

All of these details are to be found in the circuit diagram, parts list and components layout attached to this manual.

6.1.4 Important User Information

The following contains details which are essential when referring to Part 6 "Repair". This is in order to prevent misunderstandings at a later stage.

- All voltage measurements are referred to ground, if not stated otherwise.
- Abbreviations in the text, such as ST1.2, BU3.5a and B6.7 are to be understood as follows:

Plug 1 - Pin 2

Socket 3 - Pin 5a

Integrated Circuit 6 - Pin 7

- Every component mentioned is contained in Circuit Diagram 647.3518S. There are therefore no special references to this circuit diagram in the text.
- The repair of the Low-Pass Filter FK 852P5, model 02, is identical to the repair of model 05. Therefore in the following text no further reference is made to the different models.

6.2 Test Equipment

The test equipment specified in the following list will be required for performing the repairs described in this part of the manual.

Equivalent items of test equipment can be used, provided that their technical data are equal or better as those stated.

LOW - PASS FILTER
FK 852P5

Repair Manual
Part 6: Repair

- 6.3 -

6.2.1 Test Equipment List

Item no.	Test equipment, required technical data	Recommended R & S test equipment	Order no.
1	Mobile Tester	SMPF 2 SMFS 2	332.0015.53
2	Power Signal Generator $V_{out} = 0$ to 10 V EMF at 50 ohms 0.1 to 30 MHz		
3	Signal Generator 10 Hz to 30 MHz	SMK	348.0010.02
4	HF Test Receiver, 9 kHz to 30 MHz, - 30 to + 137 dB (μ V)	ESH 2	303.2020.52
5	Spectrum Analyser Frequency range: 0.1 to 100 MHz Sensitivity: > -80 dBm Level indicator range: 80 dB		
6	RF Millivoltmeter with 10 V Insertion Unit, 50 ohms, 10 V and Precision Termination, 50 ohms	URV 4 URV-Z2 RNA	292.5012.03 288.8010.55 272.4510.50
7	Noise Generator, 20 Hz to 30 MHz	SUF 2	282.8819.03
8	Digital Multimeter	UDL 33	388.8011.02
9	RF Step Attenuator 0 to 10 dB	DPSP	334.6010.02
10	Power Splitter/Combiner, 0.1 to 30 MHz	DVS	342.1014.50
11	2 Buffer amplifiers, $v = 17$ dB, $V_{out max} = 25$ dBm		
12	Service Kit	KA 852C1	648.8513.02

6.3 Troubleshooting Flowchart6.3.1 General

The following troubleshooting flowchart (Fig. 6.1) covers troubleshooting as well as fault elimination in the Low-Pass Filter FK 852P5.

For easy troubleshooting there are, where necessary, cross-references to

other measurements and procedures involved in repair.

The given sequence for the troubleshooting should be adhered to so that faults can be detected and remedied as speedily and rationally as possible.

LOW - PASS FILTER
FK 852P5

Repair Manual
Part 6: Repair

- 6.4 -

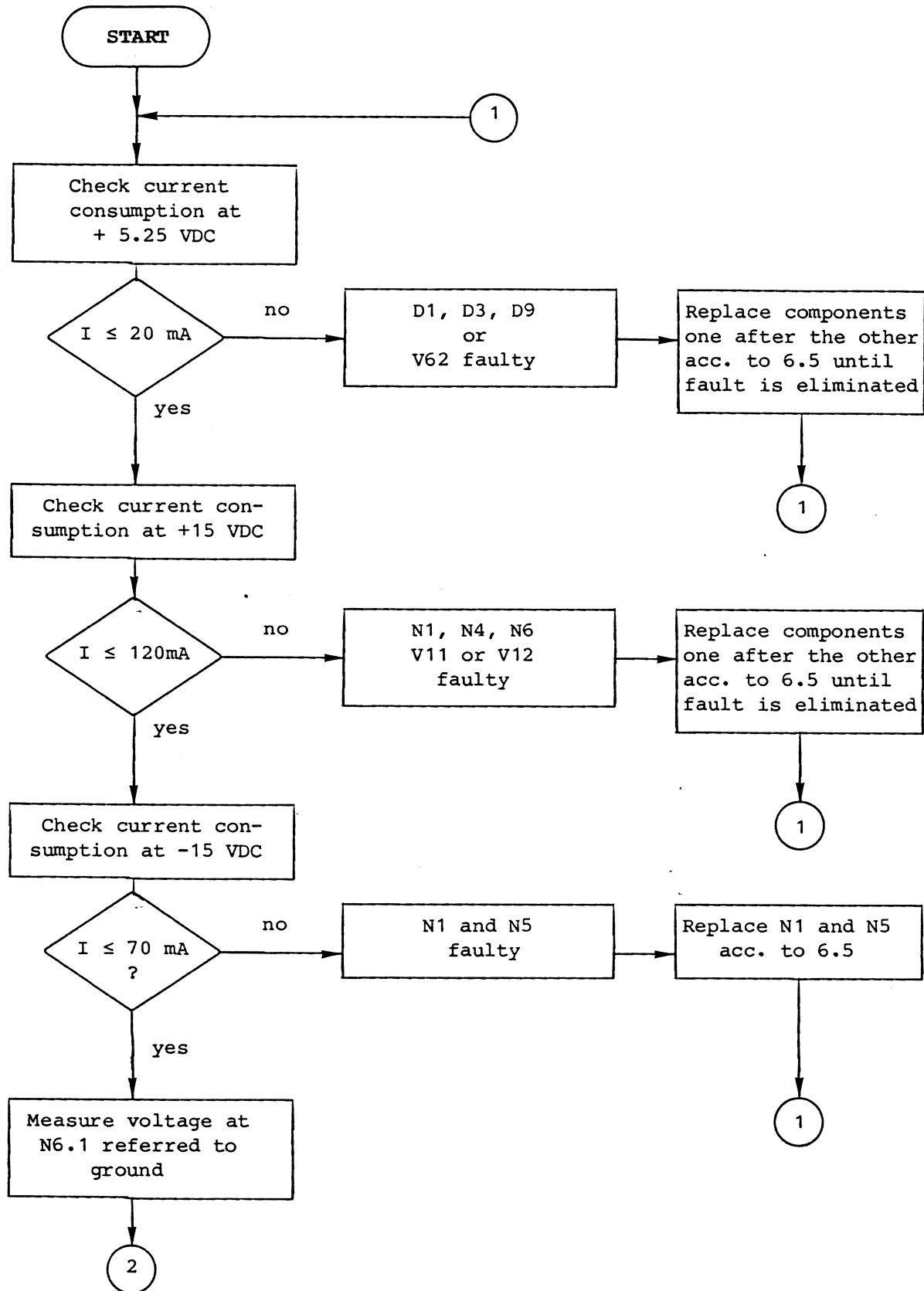

Fig. 6.1 Low-Pass Filter FK 852P5, Troubleshooting Flowchart
(Sheet 1 of 5)

LOW - PASS FILTER
FK 852P5

Repair Manual
Part 6: Repair

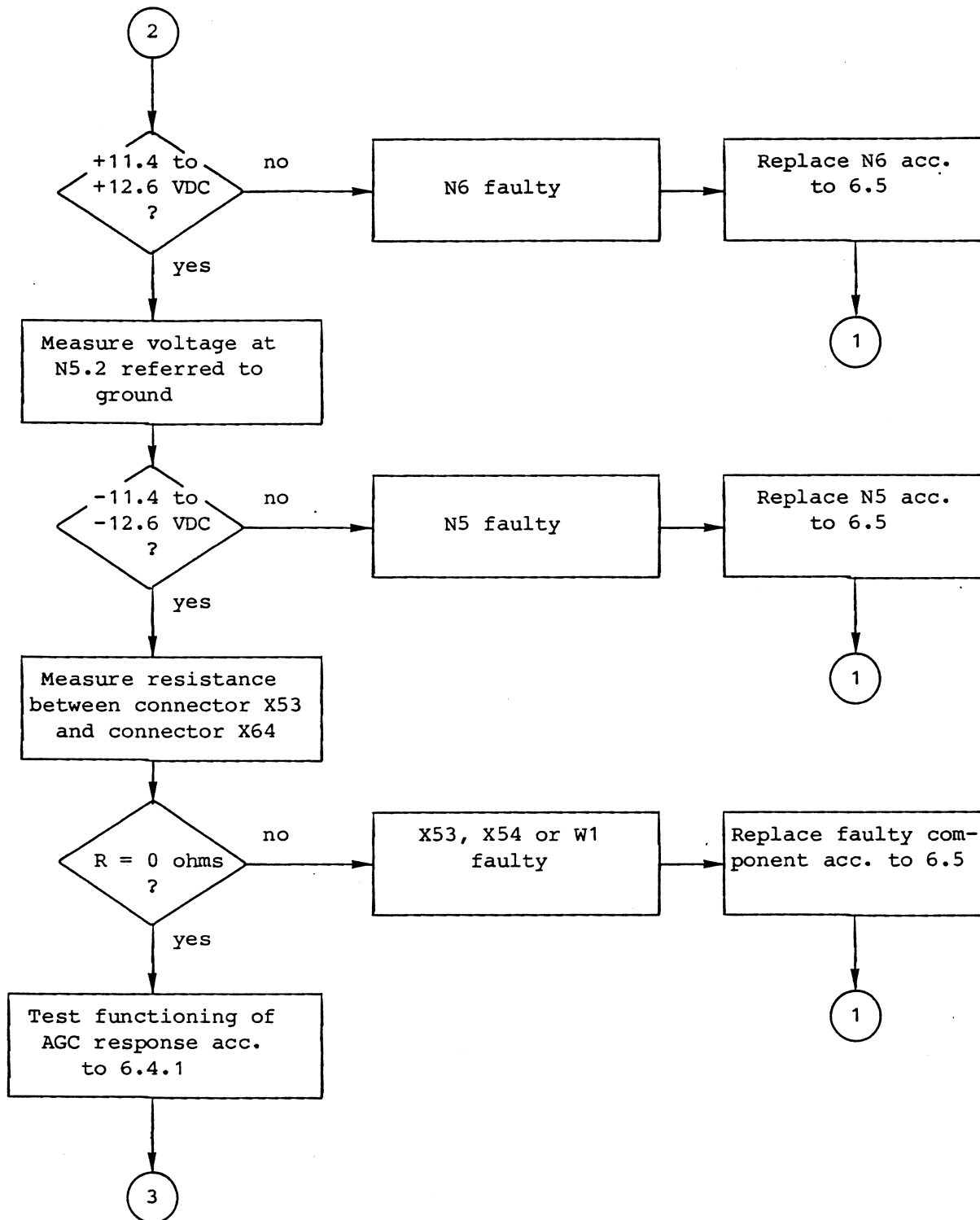

Fig. 6.1 Low Pass Filter FK 852P5, Troubleshooting Flowchart
(Sheet 2 of 5)

LOW - PASS FILTER
FK 852P5

Repair Manual
Part 6: Repair

- 6.6 -

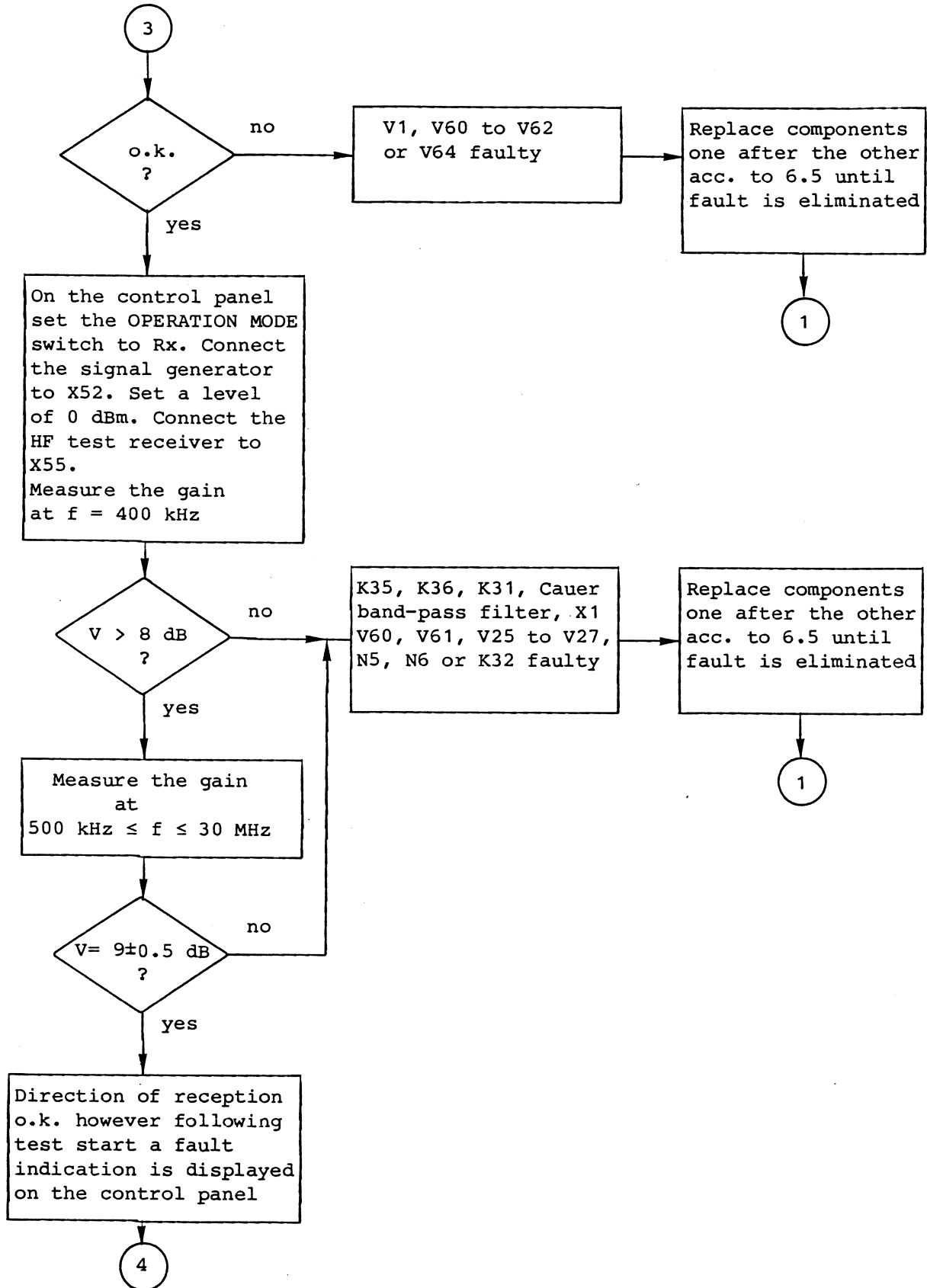

Fig. 6.1 Low-Pass Filter FK 852P5, Troubleshooting Flowchart
(Sheet 3 of 5)

LOW - PASS FILTER
FK 852P5

Repair Manual
Part 6: Repair

- 6.7 -

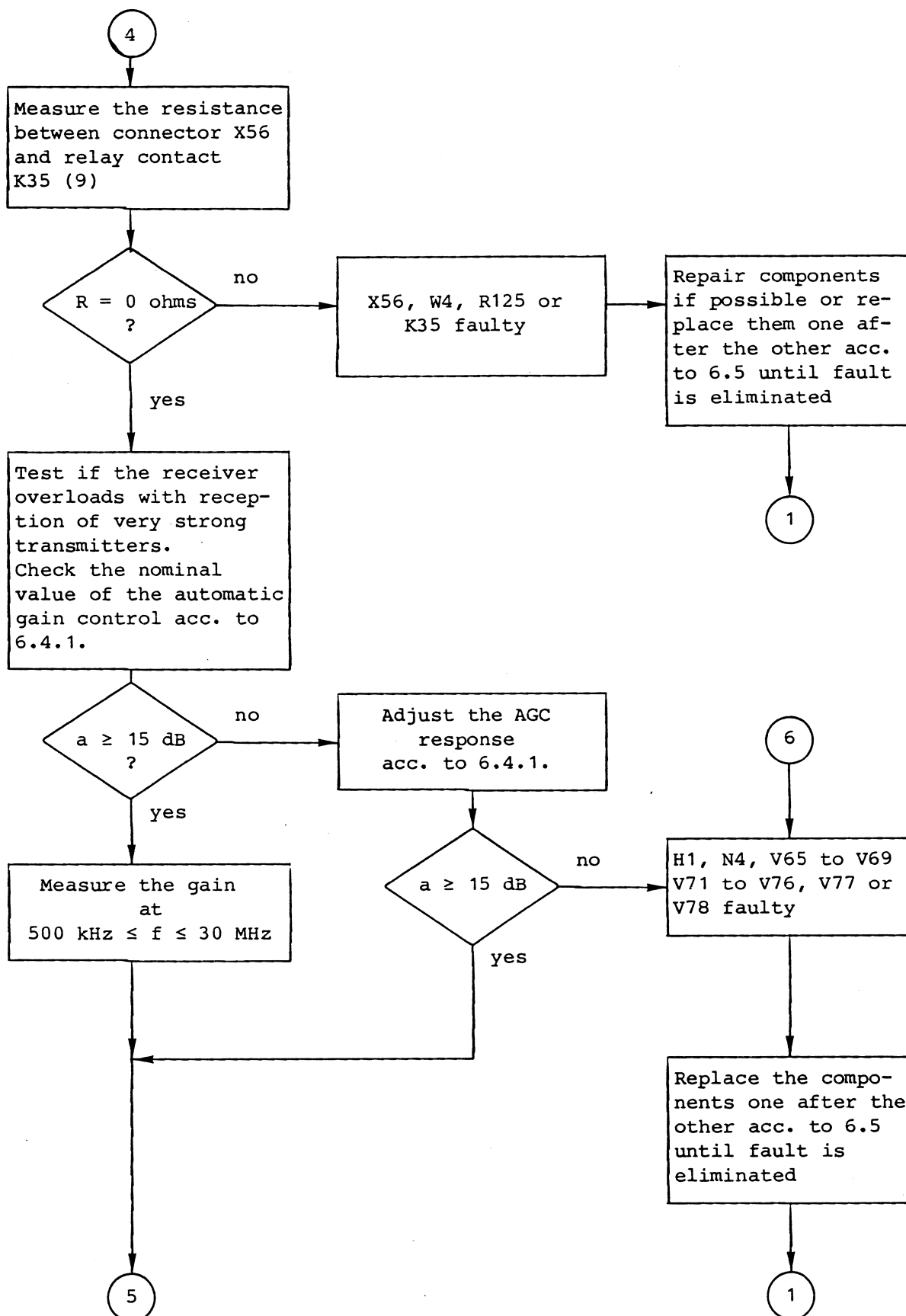

Fig. 6.1 Low-Pass Filter FK 852P5, Troubleshooting Flowchart
(Sheet 4 of 5)

LOW - PASS FILTER
FK 852P5

Repair Manual
Part 6: Repair

- 6.8 -

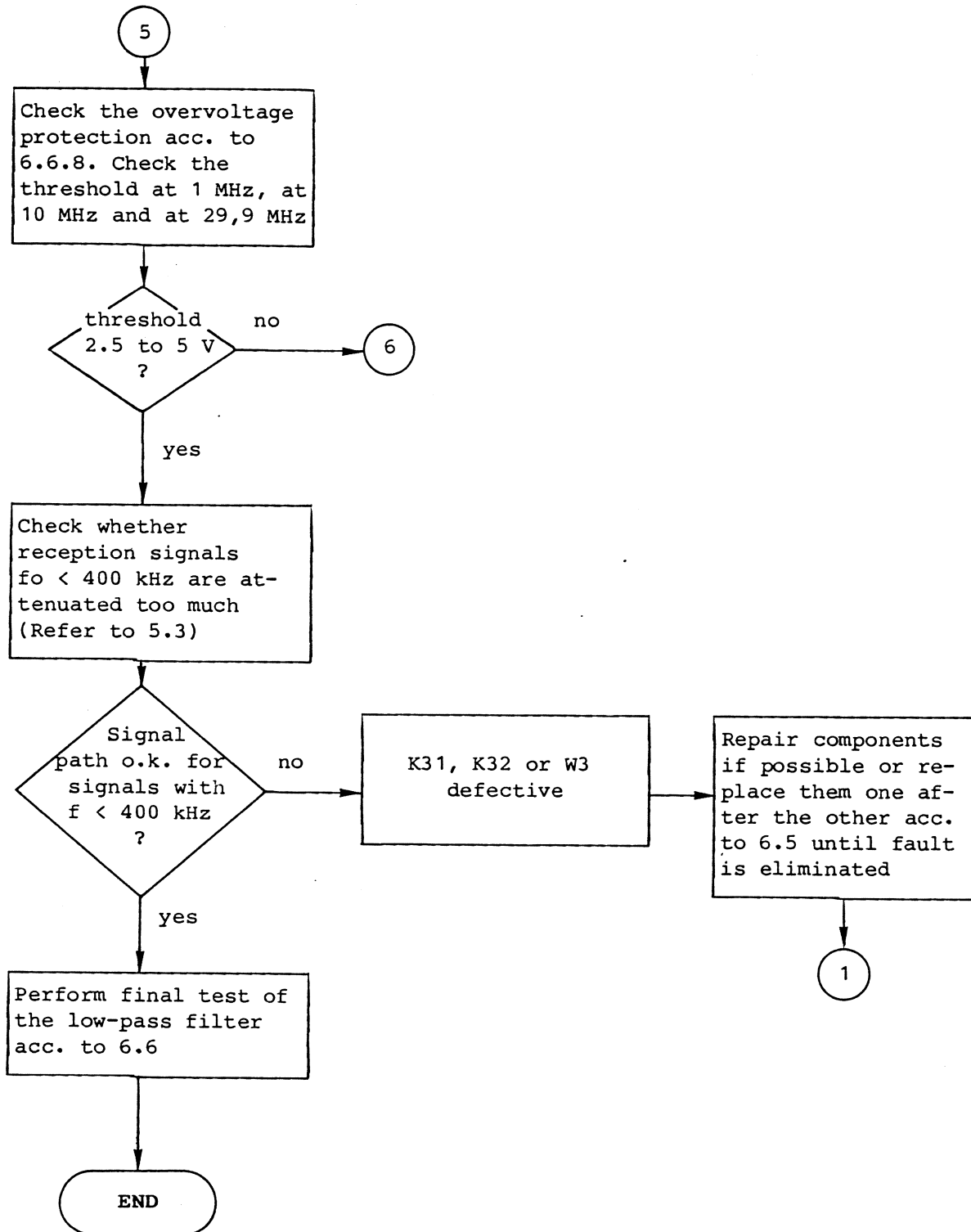

Fig. 6.1 Low-Pass Filter FK 852P5, Troubleshooting Flowchart
(Sheet 5 of 5)

**LOW - PASS FILTER
FK 852P5**

Repair Manual
Part 6: Repair

- 6.9 -

6.4 Measurements, Alignments and
Functional Checks

The measurements, alignments and functional checks below are the more detailed procedures to the instructions given in a condensed form in the troubleshooting flowchart. Consequently one will usually undertake these measurements, alignments and functional checks by branching out of the troubleshooting flowchart at a particular point. When the measurement, etc. has been performed, return to the troubleshooting flowchart at the same point where it has been left.

If a fault has been clearly identified beforehand however, one can of course commence with one of these measurements, etc. directly.

For all of these measurements or tests it is assumed that the Low-Pass Filter FK 852P5 is properly adapted to a HF transceiver. For opening the filter, refer to 6.5.

6.4.1. Adjustment of the Automatic
Gain Response

Adjust the automatic gain response circuit as follows:

1. On the control panel set the OPERATION MODE switch to Rx.
2. Connect the signal generator to connector X52.
3. Set the signal generator to a frequency of 10 MHz and to an output voltage of -70 dBm.
4. Connect the HF millivoltmeter with 10-V insertion unit to connector X55.

Note:

The connection between X55 and Tx/Rx Section GX 852P1 shall remain.

5. Connect the digital multimeter to connector X51.a21 and ground. Set the digital multimeter to volts.
6. Increase the level of the signal generator until the digital voltmeter indicates 4 ± 0.1 V (control threshold).
7. Note the reading of the RF millivoltmeter.
8. If required, adjust the control threshold (-0.5 dB referred to the output level of the signal generator) by means of potentiometer R100.
9. Increase the level of the HF signal at connector X52 until the digital voltmeter indicates: 6 ± 0.1 V.
10. Note the reading of the RF millivoltmeter.
11. Determine the control attenuation, which is the difference of the readings from step 7 and step 10.

Nominal value: $a \geq 15$ dB

6.4.2 Functional Test of the Gain

Perform the test as follows:

1. On the control panel set the OPERATION MODE switch to Rx.
2. Connect the signal generator to connector X52 of the low-pass filter.
3. On the signal generator set a level of 0 dB.
4. Connect the HF test receiver to connector X55 of the low-pass filter.

(Continuation)---

LOW - PASS FILTER
FK 852P5

Repair Manual
 Part 6: Repair

- 6.10 -

(Cont.) Funtional Test of the Gain

5. Measure the gain at $f = 400$ kHz.
 Nominal value: $v > 8$ dB
6. Measure the gain at $500 \text{ kHz} \leq f \leq 30$ MHz.
 Nominal value: $v = 9 \pm 0.5$ dB
7. Disconnect the test set-up.

If this final test does not prove satisfactory, the testing and troubleshooting following the flowchart Fig. 6.1 will have to be performed again. Repeat the procedure as many times as is necessary to detect and remedy all faults.

6.5 Replacement of Components

Before replacing any components open the low-pass filter as follows:

1. Remove the top RF cover after undoing the six Phillips screws.
2. Remove the bottom RF cover after undoing the six Phillips screws.
3. The installation is to be performed in the reverse order of the above listed procedure.

Components are to be replaced following usual workshop procedure. No special instructions are required for this.

After replacement of components continue with the troubleshooting flowchart according to Fig. 6.1.

6.6 Final Test of the Low-Pass Filter

After a repair has been carried out, the Low-Pass Filter FK 852P5 must be subjected to the following final test to ensure that its technical data can still be guaranteed.

6.6.1 Current Consumption

Nominal values:

+15 VDC ≤ 120 mA

+5.25 VDC ≤ 20 mA

-15 VDC ≤ 70 mA

6.6.2 Stabilized Voltages

Nominal values:

+12 ± 0.6 VDC

-12 ± 0.6 VDC

6.6.3 Gain Test

Perform the test as follows:

1. On the control panel set the OPERATION MODE switch to Rx.
2. Connect the signal generator to connector X52 of the low-pass filter.
3. On the signal generator set a level of 0 dB.

(Continuation)---

LOW - PASS FILTER
FK 852P5

Repair Manual
 Part 6: Repair

- 6.11 -

(Continuation) Gain Test

- | | |
|---|--|
| <p>4. Connect the HF test receiver to connector X55 of the low-pass filter.</p> <p>5. Measure the gain at $f = 400$ kHz.
 Nominal value: $v > 8$ dB</p> <p>6. Measure the gain at:
 $500 \text{ kHz} \leq f \leq 30 \text{ MHz}$.
 Nominal value: $v = 9 \pm 0.5$ dB</p> <p>7. Disconnect the test set-up.</p> | <p>3. Set the signal generator 1 to a frequency of $f_1 = 29.9$ MHz.</p> <p>4. Set the signal generator 2 to a frequency of $f_2 = 30$ MHz.</p> <p>5. Adjust the level at connector X52 to 7 dBm for each signal of f_1 and f_2.</p> <p>6. Margin of the intermodulation products:

 Nominal value ≥ 42 dB</p> |
|---|--|

6.6.4 Selection Test

Test the selection as follows:

1. On the control panel set the OPERATION MODE switch to Rx.
2. Connect the signal generator to connector X52 and adjust to a level of 0 dBm.
3. Connect the HF test receiver to connector X55.
4. Measure the attenuation at the following frequencies:

Nominal values:

$f \leq 280$ kHz	$a \geq 15$ dB
$f \geq 45$ MHz	$a \geq 15$ dB
$f \geq 50$ MHz	$a \geq 25$ dB
$f \geq 80$ MHz	$a \geq 50$ dB

Note:

Reference frequency = 1 MHz

6.6.5 Intermodulation Test

Test the intermodulation as follows:

1. Install the test set-up according to Fig. 6.2.
2. On the control panel set the OPERATION MODE switch to Rx.

6.6.6 Test of the Noise Figure

Determine the noise figure as follows:

1. Install a test set-up according to Fig. 6.3.
2. On the control panel set the OPERATION MODE switch to Rx.
3. Adjust the level of the noise generator to zero.
4. Set the HF test receiver to a reception frequency of 10 MHz.
5. Set the RF step attenuator to 3 dB.
6. Note the reading of the HF test receiver.
7. Set the RF step attenuator to 6 dB.
8. Increase the level of the noise generator until the HF test receiver reaches the reading noted in step 6.
9. The indication at the noise generator for the reading acc. to step 8 determines the noise figure F.

Nominal value for $f = 10$ MHz:

Noise figure F ≤ 3 kT_0 .

**LOW - PASS FILTER
FK 852P5**Repair Manual
Part 6: Repair- 6.12 -

**6.6.7 Test of the Automatic Gain
Control**

Test the control attenuation according to 6.4.1.

Note:The comparator N4 switches over as soon as output 14 (test point MP) switches to ≥ 15 VDC.**6.6.8 Test of the Overvoltage
Protection**

Test the overvoltage protection as follows:

For a RF voltage the nominal value of the threshold is in the range of 2.5 to 5 V at connector X52.

1. Install a test set-up according to Fig. 6.4.
2. On the control unit set the OPERATION MODE switch to Rx.
3. Remove the isolating connector X11 and terminate connector X1 with a 50-ohms termination resistor.
4. Measure at test point MP by means of the digital voltmeter.
5. Test the threshold for the following frequencies:
Test frequency : $f = 1$ MHz
 $f = 10$ MHz
 $f = 29.9$ MHz
6. At the end of the test remove the test set-up and reinstall connector X11.

LOW - PASS FILTER
FK 852P5

Repair Manual
 Part 6: Repair

- 6.13 -

6.7 External Interfaces

Socket X51	Pin	Signal designation / level
FP multipoint connector, 32-way for PCBs Contact a1 	a1	Not used
	a2	Not used
	a3	Not used
	a4	Not used
	a5	BITE selection
	a6	Strobe 3
	a7	Strobe 4
	a8	Not used
	a9	Strobe 9
	a10	0
	a11	1
	a12	2
	a13	3
	a14	4
	a15	5
	a16	6
	a17	7
	a18	Transmit
	a19	Not used
	a20	Not used
	a21	AGC RF
	a22	Not used
	a23	-15 VDC
	a24	+5.3 VDC
	a25	+5.3 VDC
	a26	+7.25 VDC
	a27	+7.25 VDC
	a28	+15 VDC
	a29	+15 VDC
	a30	Ground
	a31	Ground
	a32	Ground

Plug X52 to X56	Pin	Signal designation / level
FJ fixed connector system SMB 	X52	HF Reception 1
	X53	HF Transmission 2
	X54	HF Transmission 1
	X55	HF Reception 2
	X56	Test spectrum

LOW - PASS FILTER
FK 852P5

Repair Manual
Part 6: Repair

NOTES



ROHDE & SCHWARZ

Communications Division

Appendix

CIRCUIT DIAGRAMS

PARTS LISTS

COMPONENTS LAYOUTS

**ROHDE & SCHWARZ**

ÄZ

Datum
DateSchalteilliste für
Parts list for

FK852P5 TIEFPASS 30MHZ

Sachnummer
Stock No.

647.3518.01 SA

Blatt
Page

1

04

1285

Kennzeichen Component No.	Benennung/Beschreibung Designation	Sachnummer Stock No.	enthalten in contained in
.	VARIANTENERKL. / VERSIONS VAR 02 = GRUNDAUSFUEHRUNG VAR 05 = AUSF.EK085		
A5.1	ED TIEFPASS LOW-PASS FILTER HIERZU STROML. 647.3518 S SEE CIRC.DIAGR.647.3518 S	647.3530.02	
W90	DX FLACHBANDKABEL 64POL. NUR VAR : 05	651.7550	- ENDE -
647.3518.01 SA			BL 1-

Für diese Unterlage behalten wir uns alle Rechte vor

Kennz. Comp.No.	Benennung Designation	Sachnummer Stock No.	Hersteller Manufacturer	Bezeichnung Designation	enthalten in contained in
	VARIANTENERKL. / VERSIONS VAR 02 = GRUNDAUSFUEHRUNG MOD 02 = BASIC MODEL				
C2	CC 1NF+-10%200V5K1200VIEL CAPACITOR	CC 068.4047	UNION CARB	CK05BX102K	
C3	CC 1NF+-10%200V5K1200VIEL CAPACITOR	CC 068.4047	UNION CARB	CK05BX102K	
C8	CC 1NF+-10%200V5K1200VIEL CAPACITOR	CC 068.4047	UNION CARB	CK05BX102K	
C9	CC 1NF+-10%200V5K1200VIEL CAPACITOR	CC 068.4047	UNION CARB	CK05BX102K	
C11	CC 1NF+-10%200V5K1200VIEL CAPACITOR	CC 068.4047	UNION CARB	CK05BX102K	
C13	CE 100UF-10+50% 16V 9X13 ELECTROLYTIC CAPACITOR	CE 006.7165	ROEDERST	EK 00CB 310 D	
C14	CC 100NF+-10%50V5K1200VIE CAPACITOR	CC 084.5350	UNION CARB	CK05BX104K	
C15	CE 47UF-10+50% 40V 9X13 ELECTROLYTIC CAPACITOR	CE 006.7142	ROEDERST	EK 00 CB 247 G	
C16	CC 100NF+-10%50V5K1200VIE CAPACITOR	CC 084.5350	UNION CARB	CK05BX104K	
C17	CE 47UF-10+50% 40V 9X13 ELECTROLYTIC CAPACITOR	CE 006.7142	ROEDERST	EK 00 CB 247 G	
C18	CC 100NF+-10%50V5K1200VIE CAPACITOR	CC 084.5350	UNION CARB	CK05BX104K	
C25	CC 22PF+-2%4X5NPO CAPACITOR	CC 087.6464	PHILIPS-CO	2222 678 10229	
C29	CC 100NF+-10%50V5K1200VIE CAPACITOR	CC 084.5350	UNION CARB	CK05BX104K	
C30	CC 100NF+-10%50V5K1200VIE CAPACITOR	CC 084.5350	UNION CARB	CK05BX104K	
C32	CC 100NF+-10%50V5K1200VIE CAPACITOR	CC 084.5350	UNION CARB	CK05BX104K	
C33	CC 100NF+-10%50V5K1200VIE CAPACITOR	CC 084.5350	UNION CARB	CK05BX104K	
C34	CC 100NF+-10%50V5K1200VIE CAPACITOR	CC 084.5350	UNION CARB	CK05BX104K	
C35	CE 10 UF+-20%25V 7X 5X11 ELECTROLYTIC CAPACITOR	CE 023.5980	ROEDERSTEI	ETR 3 10/25 20%	
C36	CE 10 UF+-20%25V 7X 5X11 ELECTROLYTIC CAPACITOR	CE 023.5980	ROEDERSTEI	ETR 3 10/25 20%	
C37	CC 100NF+-10%50V5K1200VIE CAPACITOR	CC 084.5350	UNION CARB	CK05BX104K	
C90	CG 68PF+-5%300V 14X5X3 CAPACITOR	CG 417.8426	JAHRE	49.46/68/5/250	
C91	CG 68PF+-5%300V 14X5X3 CAPACITOR	CG 417.8426	JAHRE	49.46/68/5/250	
C98	CC 100NF+-10%50V5K1200VIE CAPACITOR	CC 084.5350	UNION CARB	CK05BX104K	
C99	CC 1NF+-10%200V5K1200VIEL CAPACITOR	CC 068.4047	UNION CARB	CK05BX102K	
C107	CC 10NF+-10%100V5K1200VIE CERAMIC CAPACITOR	CC 068.4060	UNION CARB	CK05BX103K	
C109	CE 33 UF+-20%10V 7X 5X11 ELECTROLYTIC CAPACITOR	CE 087.0343	ROEDERSTEI	ETR 3 33/10 20%	
C110	CC 1NF+-10%200V5K1200VIEL CAPACITOR	CC 068.4047	UNION CARB	CK05BX102K	
C111	CK 10NF+-20%630V QUADER CAPACITOR	CK 024.7763	ROEDERST	MKT1822-310/6	
C112	CK 10NF+-20%630V QUADER CAPACITOR	CK 024.7763	ROEDERST	MKT1822-310/6	
C113	CC 10NF+-10%100V5K1200VIE CERAMIC CAPACITOR	CC 068.4060	UNION CARB	CK05BX103K	
C117	CK 220NF+-20%100V QUADER PLASTIC-FOIL CAPACITOR	CK 006.5056	ROEDERST	MKT1822-422/0	
C118	CC 100NF+-10%50V5K1200VIE CAPACITOR	CC 084.5350	UNION CARB	CK05BX104K	
C129	CC 56PF+- 5%100V NPO VIEL CERAMIC CAPACITOR	CC 060.0742	UNIONCARB	C052C560J2G1CA	
C130	CK 18NF+-1%63V7,50AX13 KP CAPACITOR	CK 099.1933	SIEMENS	B33531-A5183-F	
C131	CC 5,6NF+- 5%100V NPO VIE CAPACITOR	060.0988	ERIE	8737-100-COG-5,6NF-J	
C132	CK 12NF+-1%63V7,5QUX13 KP CAPACITOR	CK 340.6760	SIEMENS	B33531-A5123-F	
C133	CK 22NF+-1%63V8X8X11 KP CAPACITOR	CK 213.4553	SIEMENS	B33531-A5223-F	

ROHDE & SCHWARZ	Äl	Datum Date	Schaltteilliste für Parts list for	Sachnummer Stock No.	Blatt Page
	14	1290	ED TIEFPASS LOW-PASS FILTER	647.3530.01 SA	1+

Kennz. Comp.No.	Benennung Designation	Sachnummer Stock No.	Hersteller Manufacturer	Bezeichnung Designation	enthalten in contained in
C134	CK 12NF+-1%63V7,5QUX13 KP CAPACITOR	CK 340.6760	SIEMENS	B33531-A5123-F	
C138	CC 120PF+- 5%100V NPD VIE CERAMIC CAPACITOR	CC 060.0788	UNIONCARB	C052C121J2G1CA	
C139	CC 22PF+- 5%100V NPD VIEL CERAMIC CAPACITGR	CC 060.0694	UNIONCARB	C052C220J2G1CA	
C140	CC 100PF+- 5%100V NPD VIE CERAMIC CAPACITOR	CC 060.0771	UNIONCARB	C052C101J2G1CA	
C141	CC 56PF+- 5%100V NPD VIEL CERAMIC CAPACITOR	CC 060.0742	UNIONCARB	C052C560J2G1CA	
C142	CC 39PF+- 5%100V NPD VIEL CERAMIC CAPACITOR	CC 060.0720	UNIONCARB	C052C390J2G1CA	
C143	CC 22PF+- 5%100V NPD VIEL CERAMIC CAPACITOR	CC 060.0694	UNIONCARB	C052C220J2G1CA	
C144	CC 12PF+- 5%100V NPD VIEL CERAMIC CAPACITOR	CC 060.0665	UNIONCARB	C052C120J2G1CA	
C145	CC 47PF+- 5%100V NPD VIEL CERAMIC CAPACITOR	CC 060.0736	UNIONCARB	C052C470J2G1CA	
D1	BL CD4013BF 2XD FLIPFL FLIPFLOP	086.8034	RCA	CD4013BF	
D3	BL CD4013BF 2XD FLIPFL FLIPFLOP	086.8034	RCA	CD4013BF	
D9	BL MM54C906J 6XN-CH.BUFF N-CHANNEL BUFFER OD	418.0264	NSC	MM54C906J	
H1	SU RD9,7X6 M.DRAHTANSCHL. SPARK-GAP VOLTAGE DISCHAR	SU 210.6161	SIEMENS	Q69-X152	
K31	SN GEPOLT 2XU 12V RELAY	645.6810	SDS	DS2E-DC12V	
K32	SN GEPOLT 2XU 12V RELAY	645.6810	SDS	DS2E-DC12V	
K35	SN GEPOLT 2XU 12V RELAY	645.6810	SDS	DS2E-DC12V	
K36	SN GEPOLT 2XU 12V RELAY	645.6810	SDS	DS2E-DC12V	
L10	LD 0,22UH10%0,140HM1,045A CHOKE	LD 067.2786	DELEVAN	DROSSEL 1025-04	
L11	LD 680 UH10%60,00HMO,030A CHOKE	LD 067.3201	DELEVAN	DROSSEL 1025-88	
L16	LD 56UH 2% 0,335A 2R3 HF-COIL	645.7445	JAHRE	74.11-56R0 TOL.+-2%	
L17	LD 27UH 2% 0,3A 2R75 CHOKE	LD 567.3987	JAHRE	74.11-27R0G	
L18	LD 220NH 2% 2A OR035 CHOKE	LD 523.7770	JAHRE	74.11-R220G	
L19	LD 330NH 2% 2A OR065 CHOKE	LD 567.4019	JAHRE	74.11-R330G	
L20	LD 150NH 2% 3,0A OR03 CHOKE	LD 567.4002	JAHRE	74.11-R150G	
L21	LD 1,20UH10%0,180HMO,620A CHOKE	LD 067.2870	DELEVAN	DROSSEL 1025-22	
L22	LD 100 UH10%8,000HMO,084A CHOKE	LD 067.3101	DELEVAN	DROSSEL 1025-68	
L23	LD 100 UH10%8,000HMO,084A CHOKE	LD 067.3101	DELEVAN	DROSSEL 1025-68	
L25	LD 150UH BEI 0,17A 6,20HM CHOKE	LD 026.4055	JAHRE	72.10-1500K	
L26	LD 150UH BEI 0,17A 6,20HM CHOKE	LD 026.4055	JAHRE	72.10-1500K	
L27	LD 150UH BEI 0,17A 6,20HM CHOKE	LD 026.4055	JAHRE	72.10-1500K	
L30	LD SPULE COIL	647.0831			
N1	BO MC1558JG 2X OPAMP OPERATIONAL AMPLIFIER	275.0816	NSC	LM1558J	
N4	BO TCA965 FENSTER-DISKR DISCRIMINATOR	BO 279.2213	SIEMENS	TCA965	
R2	RL 0,60W 4,75KOHM+-1%TK50 RESISTOR	RL 083.1097	DRALORIC	SMA0207/4,75K-F-D	
R3	RL 0,60W 4,75KOHM+-1%TK50 RESISTOR	RL 083.1097	DRALORIC	SMA0207/4,75K-F-D	
R8	RL 0,60W 4,75KOHM+-1%TK50 RESISTOR	RL 083.1097	DRALORIC	SMA0207/4,75K-F-D	

ROHDE & SCHWARZ	Äl	Datum Date	Schaltteilliste für Parts list for	Sachnummer Stock No.	Blatt Page
	14	1290	ED TIEFPASS LOW-PASS FILTER	647.3530.01 SA	2+

Für diese Unterlage behalten wir uns alle Rechte vor

Kennz. Comp.No.	Benennung Designation	Sachnummer Stock No.	Hersteller Manufacturer	Bezeichnung Designation	enthalten in contained in
R9	RL 0,60W 4,75KOHM+-1%TK50 RESISTOR	RL 083.1097	DRALORIC	SMA0207/4,75K-F-D	
R11	RL 0,60W 4,75KOHM+-1%TK50 RESISTOR	RL 083.1097	DRALORIC	SMA0207/4,75K-F-D	
R12	RL 0,60W 4,75KOHM+-1%TK50 RESISTOR	RL 083.1097	DRALORIC	SMA0207/4,75K-F-D	
R13	RL 0,60W 47,5 OHM+-1%TK50 RESISTOR	RL 082.9507	DRALORIC	SMA0207/47,5OHM-F-D	
R14	RL 0,60W 56,2 OHM+-1%TK50 RESISTOR	RL 082.9571	DRALORIC	SMA0207/56,2OHM-F-D	
R15	RL 0,60W 221 OHM+-1%TK50 RESISTOR	RL 083.0084	DRALORIC	SMA0207/221OHM-F-D	
R16	RL 0,60W 1KOHM+-1%TK50 RESISTOR	RL 082.2160	DRALORIC	SMA0207/1K-F-C	
R17	RD 0,8W 150 OHM+-1% WIRE WOUND RESISTOR	RD 087.5345	SAGE	1000S150OHM+1%	
R25	RL 0,40W 10,0 OHM+-1%TK50 RESISTOR	RL 092.1715	RESISTA	MK1 10,0OHM 1% TK50	
R31	RL 0,60W 10,0KOHM+-1%TK50 RESISTOR	RL 083.1297	DRALORIC	SMA0207/10K-F-D	
R32	RL 0,60W 10,0KOHM+-1%TK50 RESISTOR	RL 083.1297	DRALORIC	SMA0207/10K-F-D	
R51	RL 0,60W 1KOHM+-1%TK50 RESISTOR	RL 082.2160	DRALORIC	SMA0207/1K-F-C	
R52	RL 0,60W 1KOHM+-1%TK50 RESISTOR	RL 082.2160	DRALORIC	SMA0207/1K-F-C	
R90	RL 0,60W 12,10 OHM+-1%TK50 RESISTOR	RL 082.8930	DRALORIC	SMA0207/12,10OHM-F-D	
R91	RL 0,60W 10,0KOHM+-1%TK50 RESISTOR	RL 083.1297	DRALORIC	SMA0207/10K-F-D	
R92	RL 0,60W 100KOHM+-1%TK50 RESISTOR	RL 082.1764	DRALORIC	SMA0207/100K-F-C	
R93	RL 0,60W 10,0KOHM+-1%TK50 RESISTOR	RL 083.1297	DRALORIC	SMA0207/10K-F-D	
R94	RL 0,60W 100KOHM+-1%TK50 RESISTOR	RL 082.1764	DRALORIC	SMA0207/100K-F-C	
R95	RL 0,60W 4,75 OHM+-1%TK50 METALFILMRESISTOR	RL 099.8021	RESISTA	MK2 4,75 OHM 1% TK50	
R96	RL 0,60W 10,0KOHM+-1%TK50 RESISTOR	RL 083.1297	DRALORIC	SMA0207/10K-F-D	
R97	RL 0,60W 4,75KOHM+-1%TK50 RESISTOR	RL 083.1097	DRALORIC	SMA0207/4,75K-F-D	
R98	RL 0,60W 1KOHM+-1%TK50 RESISTOR	RL 082.2160	DRALORIC	SMA0207/1K-F-C	
R99	RL 0,60W 10,0KOHM+-1%TK50 RESISTOR	RL 083.1297	DRALORIC	SMA0207/10K-F-D	
R100	RS 0,5W 10KOHM+-10%10X10X5 CERMET POTENTIOMETER T	RS 247.7903	BOURNS	3386F-1-103	
R101	RL 0,60W 10,0KOHM+-1%TK50 RESISTOR	RL 083.1297	DRALORIC	SMA0207/10K-F-D	
R102	RL 0,60W 4,75KOHM+-1%TK50 RESISTOR	RL 083.1097	DRALORIC	SMA0207/4,75K-F-D	
R103	RL 0,60W 4,75KOHM+-1%TK50 RESISTOR	RL 083.1097	DRALORIC	SMA0207/4,75K-F-D	
R108	RL 0,60W 1MOHM+-1%TK50 RESISTOR	RL 082.7862	DRALORIC	SMA0207/1M-F-D	
R109	RL 0,60W 1MOHM+-1%TK50 RESISTOR	RL 082.7862	DRALORIC	SMA0207/1M-F-D	
R110	RF 0,5W 330 OHM+-5% DEPOS.-CARBON RESISTOR	007.1319	RESISTA	SK4/330OHM5%	
R111	RL 0,60W 1MOHM+-1%TK50 RESISTOR	RL 082.7862	DRALORIC	SMA0207/1M-F-D	
R112	RL 0,60W 1MOHM+-1%TK50 RESISTOR	RL 082.7862	DRALORIC	SMA0207/1M-F-D	
R113	RL 0,60W 562 KOHM+-1%TK50 RESISTOR	RL 083.2664	DRALORIC	SMA0207/562K-F-C	
R114	RL 0,60W 1MOHM+-1%TK50 RESISTOR	RL 082.7862	DRALORIC	SMA0207/1M-F-D	
R115	RL 0,60W 2.74MOHM+-1%TK50 METALFILMRESISTOR	RL 099.8980	RESISTA	MK2 2.74MOHM+-1%TK50	
R116	RL 0,60W 121KOHM+-1%TK50 RESISTOR	RL 083.2070	DRALORIC	SMA/207/121K-F-C	
R117	RL 0,60W 15,0KOHM+-1%TK50 RESISTOR	RL 083.1400	DRALORIC	SMA0207/15K-F-D	
R118	RL 0,60W 68,1KOHM+-1%TK50 RESISTOR	RL 082.2602	DRALORIC	SMA 0207/68,1K-F-C	
R119	RL 0,60W 100KOHM+-1%TK50 RESISTOR	RL 082.1764	DRALORIC	SMA0207/100K-F-C	

ROHDE & SCHWARZ	Al	Datum Date	Schaltteilliste für Parts list for	Sachnummer Stock No.	Blatt Page
	14	1290			

Für diese Unterlage behalten wir uns alle Rechte vor

Kennz. Comp.No.	Benennung Designation	Sachnummer Stock No.	Hersteller Manufacturer	Bezeichnung Designation	enthalten in contained in
R120	RL 0,60W 1KOHM+-1%TK50 RESISTOR	RL 082.2160	DRALORIC	SMA0207/1K-F-C	
R121	RL 0,60W 1KOHM+-1%TK50 RESISTOR	RL 082.2160	DRALORIC	SMA0207/1K-F-C	
R122	RL 0,60W 562 KOHM+-1%TK50 RESISTOR	RL 083.2664	DRALORIC	SMA0207/562K-F-C	
R123	RD 10W 2,7KOHM+-3%IND.ARM WIRE WOUND RESISTOR	645.7416	DALE	NH-10 2,7KOHM 3%	
R124	RL 0,60W 56,2 OHM+-1%TK50 RESISTOR	RL 082.9571	DRALORIC	SMA0207/56,20HM-F-D	
R125	RL 0,60W 56,2 OHM+-1%TK50 RESISTOR	RL 082.9571	DRALORIC	SMA0207/56,20HM-F-D	
R126	RL 0,60W 4,75KOHM+-1%TK50 RESISTOR	RL 083.1097	DRALORIC	SMA0207/4,75K-F-D	
R127	RL 0,60W 21,50 OHM+-1%TK50 RESISTOR	RL 082.9171	DRALORIC	SMA0207/21,50HM-F-D	
R128	RL 0,60W 33,2 OHM+-1%TK50 RESISTOR	RL 082.9359	DRALORIC	SMA0207/33,20HM-F-D	
R129	RL 0,60W 21,50 OHM+-1%TK50 RESISTOR	RL 082.9171	DRALORIC	SMA0207/21,50HM-F-D	
R130	RL 0,60W 33,2 OHM+-1%TK50 RESISTOR	RL 082.9359	DRALORIC	SMA0207/33,20HM-F-D	
T1	LU UEBERTRAGER TRANSFORMER	647.0825			
V11	AK BCY59IX N 45V 200MA TRANSISTOR	AK 010.5163	PHILIPS-CO	BCY59IX	
V12	AK BCY59IX N 45V 200MA TRANSISTOR	AK 010.5163	PHILIPS-CO	BCY59IX	
V25	AK BFW16A N 40V 150MA TRANSISTOR	AK 010.4644	PHILIPS-CO	BFW16A	
V26	AE BZX55/B12 0,5W ZDI ZENER DIODE	AE 218.8940	PHILIPS-CO	BZX55/B12	
V27	AE BZX79/C15 0,5W ZDI ZENER DIODE	AE 012.2555	PHILIPS-CO	BZX79/C15 GEGURTET	
V41	AD 1N4448 75V OA15 UDI DIODE	AD 012.0700	TEXAS INST	1N4448 GEGURTET	
V42	AD 1N4448 75V OA15 UDI DIODE	AD 012.0700	TEXAS INST	1N4448 GEGURTET	
V60	AE UM9401 50V PIN PIN DIODE	612.0335	UNITRODE	UM9401	
V61	AE UM9401 50V PIN PIN DIODE	612.0335	UNITRODE	UM9401	
V62	AK BC517 N 30V DARL TRANSISTOR	AK 282.2133	SIEMENS	BC517	
V64	AE BZX55/B5V1 0,5W ZDI ZENER DIODE	AE 262.5837	PHILIPS-CO	BZX55/B5V1	
V65	AD BAV21 250V OA25 UDI DIODE	AD 082.6837	INTERMETAL	BAV21	
V66	AD BAV21 250V OA25 UDI DIODE	AD 082.6837	INTERMETAL	BAV21	
V67	AE BZX55/B8V2 0,5W ZDI ZENER DIODE	AE 012.2178	PHILIPS-CO	BZX55/B8V2	
V68	AD 1N4448 75V OA15 UDI DIODE	AD 012.0700	TEXAS INST	1N4448 GEGURTET	
V71	AD BAV10 60V OA3 UDI DIODE	AD 012.9437	PHILIPS-CO	BAV10	
V72	AE BZT03/C12 3.2W ZDI ZENER DIODE	AE 007.4182	PHILIPS-CO	BZT03/C12	
V76	AD BAV21 250V OA25 UDI DIODE	AD 082.6837	INTERMETAL	BAV21	
V77	AD BAV21 250V OA25 UDI DIODE	AD 082.6837	INTERMETAL	BAV21	
V78	AD BAV21 250V OA25 UDI DIODE	AD 082.6837	INTERMETAL	BAV21	
V80	AD 1N4448 75V OA15 UDI DIODE	AD 012.0700	TEXAS INST	1N4448 GEGURTET	
V81	AD 1N4448 75V OA15 UDI DIODE	AD 012.0700	TEXAS INST	1N4448 GEGURTET	
V82	AD FDH300 125V OA50 UDI DIODE	AD 012.1442	FAIRCHILD	FDH300	
W1	DW KABEL	647.3918			
W2	DW KABEL	647.3924			
W3	DW KABEL	647.3930			
W4	DW KABEL	647.3947			
W8	DW KABEL	647.3953			

ROHDE & SCHWARZ	Äl	Datum Date	Schaltteilliste für Parts list for	Sachnummer Stock No.	Blatt Page
	14	1290	ED TIEFPASS LOW-PASS FILTER	647.3530.01 SA	4+

Kennz. Comp.No.	Benennung Designation	Sachnummer Stock No.	Hersteller Manufacturer	Bezeichnung Designation	enthalten in contained in		
X1	FP STIFTLISTE 36P.R2,54 PIN CONNECTOR 4-POLIG/4 PINS	FP 242.3600	BINDER	742-5-11-0178-00-36	- ENDE -		
X2	FP STIFTLISTE 36P.R2,54 PIN CONNECTOR 3-POLIG	FP 242.3600	BINDER	742-5-11-0178-00-36			
X3	FP STIFTLISTE 36P.R2,54 PIN CONNECTOR 3-POLIG	FP 242.3600	BINDER	742-5-11-0178-00-36			
X11	FP KURZSCHLUSSBUCHSE SHORTING PLUG	FP 491.7042	PK	452-70302			
X12	FP KURZSCHLUSSBUCHSE SHORTING PLUG	FP 491.7042	PK	452-70302			
X13	FP KURZSCHLUSSBUCHSE SHORTING PLUG	FP 491.7042	PK	452-70302			
X51	FP STECKERLEISTE 32POL. MULTIPOINT CONNECTOR	FP 514.4550	PANDUIT	100-232-033/999			
X52 ..56	FJ EINBAUSTECKER SYST.SMB FIXED CONNECTOR	FJ 063.5116	ROSENBERG	59S601-200D2			
- ENDE -							
ROHDE & SCHWARZ		Äl	Datum Date	Schaltteilliste für Parts list for		Sachnummer Stock No.	Blatt Page
		14	1290	ED TIEFPASS LOW-PASS FILTER		647.3530.01 SA	5-



ROHDE & SCHWARZ

Communications Division

Repair Manual

CONTROL UNIT

GB 853C1

649.4011

©

Copying of this document as well as any other utilization and communication of its content are only admissible with the permission of the originator or other authorized persons.

Any disregard will be prosecuted and is subject to restitution (UrhG, UWG, BGB). For the case a patent is issued or the design is officially registered all rights are reserved.

ROHDE & SCHWARZ GmbH & Co. KG · D-81671 München · Mühldorfstr. 15 · Tel. (089) 4129-0 Int. +4989 4129-0

Telefax (089)4129-2164 Int. +49894129-2164

**Printed in the Federal Republic of Germany · Subject to change · Data without tolerances: order of magnitude only
0694**



Control Unit GB 853, Standard Version

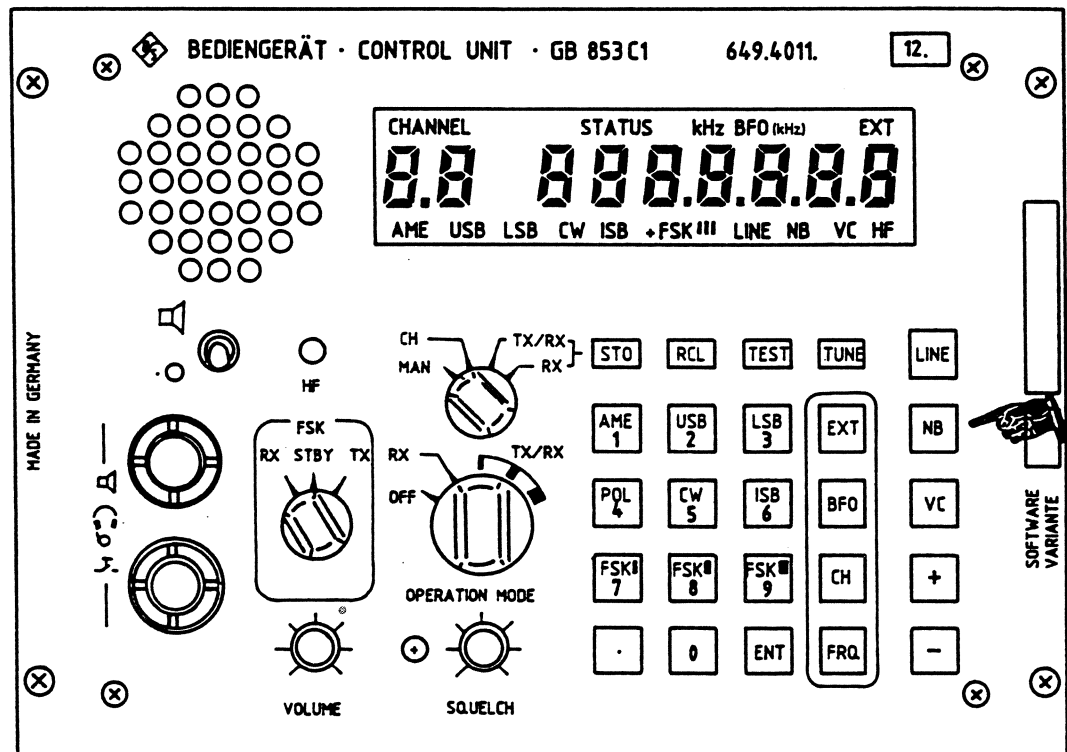

NOTE

Please note that a new function has been assigned to the key NB (noise blanker) on Control Unit GB 853.

If the control unit is used together with 400-W Transceivers XK 855 and with 1-kW Transceivers XK 859 the amplifier control and the collector voltage for single-tone modulation in AME, USB, LSB and ISB can be switched over with key NB. This allows for a higher efficiency of the power stage and thus for more gentle operation.

CONTROL UNIT • GB 853C1

Repair Manual

List of Contents

1. **Characteristics**
2. **Preparation for Use**
3. **Operation**
4. **Maintenance and Troubleshooting**

Note: These chapters are contained in the user manual GB 853C1.

5. Description of Function

	Page
5.1 General	5.1
5.2 Processor Board	5.2
5.3 Audio Board	5.4
5.4 Filter Board	5.7
5.5 Keyboard PCB	5.7
5.6 Display Board	5.7
5.7 Motherboard	5.8
5.8 Configuration	5.9
5.8.1 Switch S1 (Processor Board)	5.9
5.8.2 Jumpers X104.1 to X104.9 (Processor Board)	5.9
5.8.3 Jumpers X21, X22, X31, X32 (Audio Board)	5.9
5.8.4 Jumper X41 (Audio Board)	5.9

CONTROL UNIT • GB 853C1

Repair Manual

6. Repair

	Page
6.1	Preliminary Remarks 6.1
6.1.1	General 6.1
6.1.2	Restoring the Nominal Characteristics 6.1
6.1.3	Spare Parts 6.1
6.1.4	Important User Information 6.2
6.2	Test Equipment and Special Tools 6.3
6.3	Troubleshooting 6.4
6.3.1	General 6.4
6.3.2	Visual Inspection 6.4
6.4	Measurements, Alignment and Functional Checks 6.20
6.4.1	Power Supply 6.20
6.4.1.1	Check of Current Consumption 6.20
6.4.1.2	Check of + 5.3-VDC Supply Voltage 6.20
6.4.2	Processor Board 6.21
6.4.2.1	Check of Current Consumption 6.21
6.4.2.2	Check of + 5.3-VDC Supply Voltage 6.21
6.4.2.3	Check of Oscillator Frequency 6.21
6.4.2.4	Check of System Clock 6.21
6.4.2.5	Check of Interrupt Request Pulses 6.22
6.4.3	Audio Board 6.22
6.4.3.1	Check of AF Reception 6.22
6.4.3.2	Check of AF Transmission 6.24

CONTROL UNIT • GB 853C1

Repair Manual

	Page
6.4.3.3	Check of TTY Operation, Line Current 6.25
6.4.3.4	Check of TTY Operation, V.28 Interface 6.26
6.4.4	Filter Board 6.27
6.4.4.1	Check of T Networks 6.27
6.4.4.2	Check of II Networks 6.29
6.4.5	Keyboard PCB 6.30
6.4.6	Display Board 6.30
6.4.6.1	Check of Switches S2, S3 and S4 6.30
6.4.6.2	Check of LED "SQUELCH" 6.31
6.4.6.3	Check of Clock Generator 6.31
6.4.6.4	Check of Illumination Unit 6.32
6.4.7	Motherboard 6.32
6.4.7.1	Check of Supply Voltages 6.32
6.4.7.2	Check for Continuity 6.32
6.4.7.3	Check for Short-circuit 6.32
6.5	Replacement of Assemblies and Components 6.33
6.5.1	Preparations 6.33
6.5.2	Replacement of Individual Components 6.34
6.6	Final Test 6.35
6.6.1	Test of AF Reception 6.35
6.6.1.1	Test of Loudspeaker Amplifier 6.35
6.6.1.2	Test of Headphones Amplifier 6.36
6.6.1.3	Test of AF Reception 6.36
6.6.2	Test of AF Transmission 6.36
6.6.2.1	Test of AF Modulation 6.36
6.6.2.2	Test of Microphone Transmission 6.36
6.6.3	Test of Squelch 6.37

CONTROL UNIT • GB 853C1
Repair Manual

	Page
6.6.4	Test of TTY Operation, Line Current 6.38
6.6.4.1	Test of Reception 6.38
6.6.4.2	Test of Transmission 6.39
6.6.5	Test of TTY Operation, V.28 Interface 6.39
6.6.5.1	Test of Reception 6.39
6.6.5.2	Test of Transmission 6.40
6.7	External Interfaces 6.40

CONTROL UNIT • GB 853C1

Repair Manual

List of Figures

Fig.	Title	Page
5.1	Control Unit GB 853C1, Block Diagram	5.11
6.1	Troubleshooting Flowchart, Control Unit GB 853C1	6.5
6.2	Troubleshooting Flowchart, Processor Board	6.7
6.3	Troubleshooting Flowchart, Audio Board, AF Section	6.9
6.4	Troubleshooting Flowchart, Audio Board, FSK Section	6.12
6.5	Troubleshooting Flowchart, Filter Board	6.15
6.6	Troubleshooting Flowchart, Keyboard PCB	6.16
6.7	Troubleshooting Flowchart, Display Board	6.17
6.8	Troubleshooting Flowchart, Motherboard	6.19
6.9	Test Set-up, Control Unit GB 853C1	6.41
6.10	Test Set-up, Processor Board	6.41
6.11	Test Set-up, Audio Board, AF Reception	6.43
6.12	Test Set-up, Audio Board, AF Transmission	6.43
6.13	Test Set-up, Audio Board, TTY Operation (Line Current)	6.45
6.14	Test Set-up, Audio Board, TTY Operation (V.28 Interface)	6.45
6.15	Test Set-up, Filter Board	6.47
6.16	Test Set-up, Keyboard PCB	6.47
6.17	Test Set-up, Display Board	6.49
6.18	Test Set-up, Motherboard	6.49
6.19	Test Set-up, Control Unit, AF Section	6.51
6.20	Test Set-up, Control Unit, FSK Section	6.53

CONTROL UNIT • GB 853C1

Repair Manual

Appendix Interface Description, Circuit Diagrams, Parts Lists and Components Layouts

Interface Description, Control Unit GB 853C1	A.1
Circuit Diagram, Control Unit GB 853C1	649.4011.01S
Parts List, Control Unit GB 853C1	649.4011.01SA
Circuit Diagram, Keyboard PCB	649.4111.01S
Parts List, Keyboard PCB	649.4111.01SA
Components Layout, Keyboard PCB	649.4111.01 sheet 2
Circuit Diagram, Display Board	649.5676.01S
Parts List, Display Board	649.5676.01SA
Components Layout, Display Board	649.5676.01 sheet 2
Circuit Diagram, Filter Board	649.4157.01S
Parts List, Filter Board	649.4157.01SA
Components Layout, Filter Board	649.4157.01 sheet 2
Circuit Diagram, Processor Board	649.4170.01S
Parts List, Processor Board	649.4170.01SA
Components Layout, Processor Board	649.4170.01 sheet 2

CONTROL UNIT • GB 853C1

Repair Manual

Circuit Diagram, Audio Board	649.4192.01S
Parts List, Audio Board	649.4192.01SA
Components Layout, Audio Board	649.4192.01 sheet 2
Parts List, Motherboard	649.4211.01SA
Components Layout, Motherboard	649.4211.01 sheet 2
Parts List, Illumination Unit	649.5699.01SA
Components Layout, Illumination Unit	649.5699.01 sheet 2

CONTROL UNIT • GB 853C1

Repair Manual • Description of Function

5. Description of Function

(See Fig. 5.1, Block Diagram and circuit diagram 649.4011.01S)

5.1 General

Control Unit GB 853C1 belongs to the HF 850 series of radio equipment. It is designed for local, detached or remote operation of a connected radio set. The control unit has the following tasks:

- Input of all data necessary for the operation of a connected radio set via a keyboard
- Conversion of fed-in operational functions to control or data telegrams and transmission of such telegrams via the V.24 interface to the radio set
- Evaluation of acknowledgements and error messages of the radio set and indication of messages on the LC display
- Recognition of wrong data entered with the aid of the keyboard and indication of such data on the LC display
- Connection and operation of a teletypewriter with line current connection (single / double current) or V.28 interface
- Connection of loudspeaker, Morse key or headphones
- Triggering of self-test routine for check of the radio set and for signalling the relevant status

The control unit mainly consists of five complex assemblies:

- Processor board,
- Audio board,
- Filter board,
- Keyboard PCB and
- Display board with illumination unit

These assemblies are printed circuit boards which are connected to each other and to devices externally connected to the control unit.

The microprocessor on the processor board controls and monitors the internal functional processes in the control unit and the data transmission in conjunction with the USART component between the control unit and the radio set. It evaluates acknowledgements from the radio set as well as wrong operation and causes these to be shown on the LC display.

The audio board, consisting of an AF and an FSK section, is used for Tx / Rx operation for AF signals as well as for the operation of a teletypewriter with line current connection or V.28 interface.

In AF reception AF signals of the radio set are amplified and fed to the connected loudspeaker or headphones. In AF transmission the AF signal is fed from the microphone via the microphone amplifiers and level-matching networks to the transmission lines.

For operation of a teletypewriter with line current connection the FSK section contains voltage converters with line current circuits for single currents (60 V / 40 mA) or double currents (± 30 V / ± 20 mA). For operation of a teletypewriter with V.28 interface the section is provided with two level converters which convert data signals to transmission level.

The EMC filters of the filter board prevent interfering signals from entering the lines of the externally connected loudspeaker, Morse key or headphones.

The keyboard of the keyboard PCB is used for entering all the information required for operation, such as frequency, channel etc.. The indicators of the display board, such as the LC display, signal the relevant operating conditions as well as the settings entered via the keyboard. The display board and the keyboard PCB are driven and called up by means of the processor board.

Models 12, 13 and 14 of the control unit only differ with respect to their colours.

CONTROL UNIT • GB 853C1

Repair Manual • Description of Function

5.2 Processor Board

(See circuit diagram 649.4170.015)

The central processing unit of the processor board (CPU) is microprocessor D1 type 8085. The CPU mainly consists of a clock oscillator, assemblies for input and output control and assemblies for internal processing of address and data signals.

The frequency of the integrated clock oscillator is determined by oscillator crystal B1, which is connected to signal inputs X1 and X2 of the CPU D1. The frequency of the oscillator crystal is 6.144 MHz. On the basis of this frequency the CPU produces a system clock of 3.072 MHz and outputs it to D1.37.

Upon switch-on the reset signal establishes a defined initial CPU status. From the power supply of the radio set this signal is fed to the CPU reset input D1.36 via contact X41.A6 as well as pulse-forming Schmitt triggers D7.11, .10 and D7.9, .8.

RST7.5 interrupt input D1.7 is driven by the timer output of I / O port D14.6. RST6.5 interrupt input (D1.8) and RST5.5 interrupt input (D1.9) are used for Rx-RDY and Tx-RDY signals of USART component D6.

The maskable interrupt input INTR (D1.10) is driven by interrupt controller D10. The controller registers all interrupts occurring on the processor board and forwards them to the CPU in accordance with the priorities determined by the program. The controller is activated by address decoder D2 via address C000H.

The following tasks of the interrupts are coordinated by interrupt controller D10:

- Switchover of the operation mode switch (IR0)
- Key activation (IR1)
- Switchover of the control mode switch (IR2)
- Carrier activation (IR3) and
- FSK-STBY switchover (IR4)

Interrupt inputs IR5 to 7 are not used.

Switchover of the operation mode switch (S4, display panel) causes one of contacts X41.A19 to .A21, .B19, .B20 to be switched to ground. A logic circuit, consisting of four OR gates D16 and an AND gate D15, applies this changed value from output D15.13 to the IR0 input of the interrupt controller D10. The controller triggers an interrupt pulse and forwards it to the interrupt input D1.10 of the CPU. The CPU produces an interrupt and reads the new setting of the operation mode switch into I / O port D13 (inputs PB7 to PB3) during the interruption.

The activation of a key on the keyboard PCB produces a high level via contacts X41.A22, .A23, .B21, .B22 at NAND gate output D17.13. The rising edge of this pulse is forwarded to IR1 input D10.19 of the interrupt controller. The controller triggers an interrupt pulse and forwards it to the interrupt input D1.10 of the CPU. The CPU triggers an interrupt thus producing the transmission of pulses at outputs PA0 to PA7 of I / O port D14 to the keyboard. The CPU recognizes which of the keys connects one of outputs PA0 to PA7 to one of inputs PC0 to PC3.

Switchover of the operation mode switch (S2, display panel) causes one of contacts X41.A17, .A18, .B17, .B18 to be switched to ground. A logic circuit, consisting of three OR gates D19 and an AND gate D15, applies this changed value from output D15.1 to the IR2 input of the interrupt controller D10. The controller triggers an interrupt pulse and forwards it to the interrupt input D1.10 of the CPU. The CPU produces an interrupt and reads the new setting of the operation mode switch into I / O port D13 (inputs PA4 to PA7) during the interruption.

The carrier activation interrupt is generated by the switching edge of the carrier activation signal (D2, audio board). This signal is fed from contact X41.A9 via pulse-forming RC network R41 / C34 to Schmitt trigger D7.13, .12 and, at the same time, to EXOR gate D9.5, .6, .4. Upon each switching edge of the carrier activation signal, the output of the Schmitt trigger generates a pulse which is forwarded via EXOR gate D9.5, .6, .4. to input IR3 of interrupt controller D10, which in turn triggers the interrupt.

CONTROL UNIT • GB 853C1

Repair Manual • Description of Function

Upon switchover of the FSK switch (S3, display board), contact X41.A16 is switched to ground or separated from ground. This switchover pulse is forwarded via pulse-forming RC network R11 / C21 to Schmitt trigger D7.5, .6 and, at the same time, to EXOR gate D9.8, .9, .10. Upon each switching edge of the carrier activation signal the output of the Schmitt trigger generates a pulse which is forwarded via EXOR gate D9.8, .9, .10 to the IR4 input of interrupt controller D10, which in turn triggers the FSK-STBY interrupt.

The program for the control of the control unit is stored in EPROMs (Erasable Programmable Read-only Memory) D4 and D5. Addressing of the EPROMs is achieved by means of address decoder D2 which activates EPROM D4 by means of CE signal Y0 and EPROM D5 by means of CE signal Y1. Simultaneously, the address decoder generates the required EPROM addresses from the multiplexed data and address bus. By means of 8-bit latch D3 the data are stored temporarily.

The V.24 interface is operating with the aid of USART D6. All functions of the V.24 interface can be set by means of jumpers X104.1 to X104.10 (see 5.8).

The outputs of USART D6.19, .23, .24 are connected to interface driver D11 via the jumpers or Schmitt triggers of integrated circuit D7. The interface driver amplifies the output signals and serves as level-matching network. The output signals of the interface driver are forwarded via contacts X41.A4, .A5, .B4, .B5 to external interface X61.

The inputs of USART D6.3, .9, .17, .22, .25 are connected to receive comparator D12 which matches the signals of contacts X41.A1, .A2, .B1, .B2, .B3 to the USART.

The transmission baud rate for the USART is routed to Tx C / Rx C inputs of USART D6.9, .25 from the integrated timer of I/O port D13.6. The baud rate is set to 2400 Bd.

Integrated circuits D13 and D14 are used as I/O ports each of which contains a timer and a 2-k-RAM for temporary storage in addition to the input and output circuits.

Via inputs D13.32 to .36 of the I/O port the operation mode can be set and via D13.25 to .28 the control mode. The baud rate is set by means of switch S1 at inputs D13.11, .22, .23, .24 and the clock is decoupled at timer output D13.6. At inputs D13.30 and D13.31 the storage and the software carrier activation inhibit is set by means of jumpers X104.8 and X104.9.

Relay K1 is switched via output D13.39 and transistor V2. In the test mode the make contacts of the relay interconnect input and output of the V.24 interface. The V.24 interface is tested by means of a data telegram transmitted and simultaneously received again by the CPU.

From outputs D13.1, .2, .37, .38 control signals are fed to connector X41.

Input D14.5 of I/O port D14 processes the carrier activation signal and input D14.2 the FSK-STBY signal. Via connector X41 the keyboard is interrogated at inputs / outputs D14.1, .21 to .28, .37 to .39. Outputs D14.29 to .36 control the LC display on the display board via connector X41. At timer output D14.6 the timer interrupt for the CPU is decoupled.

The 5.3-VDC supply voltage for the processor board is tapped at voltage regulator D18.4. The control voltage can be set by means of resistor R52.

CONTROL UNIT • GB 853C1

Repair Manual • Description of Function

5.3 Audio Board

(See circuit diagram 649.4192.015)

The audio board consists of an AF section and an FSK section. The tasks of the audio board are transmission / reception of AF signals as well as operation with a teletyper with line current connection or V.28 interface.

In AF transmission the AF signal is processed in the microphone amplifier which consists of the preamplifier and a dynamic compressor with clipper.

The AF signal is forwarded from contact X51.B30 (microphone input) via choke L2, RC network C1, C2, C4, R4, R3 and diode limiter V1, V2 to preamplifier N1.1, .2, .3.

The amplified AF signal at the output of preamplifier N1.1 is forwarded to the dynamic compressor which consists of operational amplifiers N1.8, .9, .10 (amplifier), N2.1, .2, .3 (comparator) and field effect transistor V4. The comparator compares the AF voltage available at contact N2.3 to the control voltage available at N2.2 which is produced by Zener diode V6. The output voltage at contact N2.1 controls amplifier N1.8, .9, .10 via field effect transistor V4. For this purpose the output level of the AF voltage at output N1.8 of the amplifier is kept constant.

The AF signal at output N1.8 of the amplifier is forwarded via resistor R19 to the clipper consisting of operational amplifiers N2.8, .9, .10 (comparator), N2.13, .14, .15 (comparator) and N2.5, .6, .7 (inverter). The control voltage generated by Zener diode V6 is applied to comparator input N2.10 via resistor R27. At the same time the control voltage is applied to comparator input N2.12 via inverter N2.5, .6, .7.

At the output of the clipper the level of the AF signal is matched to the following circuits by means of operational amplifier N1.5, .6, .7 and is fed to contact X51.B9 via lowpass filter R34, R35, C9 as well as relay contacts K1.12, .2.

In AF transmission the carrier activation signal is triggered by means of the following signals at the contacts given below:

- X51.A17: signal "Transmit" from external contact X61.A18 or by means of the transmit key connected to the filter board
- X51.B13: signal "F1" from the processor board,
- X51.B16: signal "S" from the display board,
- X51.A16: Signal "F1 Transmit" from external contact X61.A17.

The respective signal is forwarded to logic gate D1 and / or D4. By means of contact X51.B25 this signal and the "PTT inhibit" signal are logically interconnected. When the carrier activation inhibit is not triggered, the carrier activation signal is available at the output of gate D1.4. It is then debounced in integrated circuit D2 and converted from TTL level to V.24 interface level in driver N5.

In case the AF signal is fed in at the external interface X61.A15, .A16 and not at the microphone input, switchover of the signal path is achieved by means of the LINE signal at contact X51.B14 via amplifier N5.3, .14 and relay K1.

In AF reception the AF signal is fed in at contact X51.B11 and is multiplexed to the following assemblies:

- Squelch circuit
- Loudspeaker amplifier
- Headphones amplifier
- AF receive circuit

In the squelch circuit the AF signal is fed to amplifier input N3.5. After level-matching the signal is forwarded from the output of amplifier N3.7 to a bandpass filter with a cut-off frequency of 500 Hz. The bandpass filter consists of amplifier N3.8, .9, .10, RC network C24 to C26, R62, R63 and amplifier N4.1, .2, .3.

CONTROL UNIT • GB 853C1

Repair Manual • Description of Function

The output signal at contact N4.1 is fed to monoflop input D8.4 where it triggers the monoflop. Together with the following lowpass filter R65, R66, C28, C29 the monoflop converts the frequency changes of the AF signal into voltage changes. The signal thus generated is forwarded via amplifier N4.5, .6, .7 to the input of operational amplifier N4.13 which, together with diodes V18, V19, is used as rectifier.

In comparator N4.9, .10, .8 the rectified signal is compared to the control voltage which is fed in at contact X51.A20 and can be adjusted with the aid of the squelch potentiometer. The signal at comparator output N4.8 triggers the following monoflop D8.9 to .15.

The phase of the squelch signal available at output D8.10 is shifted in phase by means of transistor V22 and is available at contact X51.A18 for further processing.

At the same time, the squelch signal is forwarded from inverting output D8.9 to analog switches D7.3, .4, .5 and D7.6, .8, .9. When the level of the squelch signal is high, analog switch D7.3, .4, .5 switches resistor R100 to the input of the headphones amplifier N6. Simultaneously analog switch D7.6, .8, .9 switches resistor R96 to the input of loudspeaker amplifier N7. The input signals of these amplifiers are thus attenuated by approx. 20 dB.

For the loudspeaker amplifier the AF signal from the VOLUME potentiometer on the front panel is forwarded to amplifier input N7.8 via contact X51.B19, resistor R99 and capacitor C50. The components necessary for temperature and frequency compensation are connected to the amplifier. The amplified AF signal is forwarded from output N7.12 via electrolytic capacitor C46 to contact X51.A22.

If necessary, the loudspeaker amplifier can be separated from the AF signal path. Via inverter N1.12, .13, .14 and resistor R21 analog switches D7.1, .2, .13 and D7.10, .11, .12 are controlled by means of the signal "Loudspeaker OFF" at contact X51.A29.

In this case the analog switch D7.10, .11, .12 switches the AF signal line to ground. Analog switch D7.1, .2, .13 prevents the squelch signal from attenuating the AF signal for headphones amplifier N6 via analog switch D7.3, .4, .5.

For the headphones amplifier the AF signal from the VOLUME potentiometer on the front panel is forwarded to amplifier input N6.8 via contact X51.B19, resistor R107 and capacitor C64. Amplifier N6 is temperature- and frequency-compensated. The amplified AF signal is forwarded from output N7.12 via electrolytic capacitor C57 to contact X51.B28.

For the AF receive circuit the AF signal is forwarded from contact X51.B11 via lowpass filter C18, C19, R46, R47 to amplifier N3.1, .2, .3. The amplified AF signal is applied to contact X51.A12 (AF reception) from output N3.1 via resistor R48.

For operation of a teletyper the audio board provides the following transmission and reception modes:

- Line current operation, single current
- Line current operation, double current
- V.28 interface operation

In order to guarantee line current operation, the audio board is provided with a line current source which consists of the components for clock generation and the push-pull converter.

Astable multivibrator D5 generates the clock. The multivibrator frequency of approx. 80 kHz is determined by RC network R186, C145. At outputs D5.10 and D5.11 two anti-phase rectangular pulses are decoupled and each of these pulses is sent to one of the D flipflops of integrated circuit D6. The anti-phase output pulses of the D flipflops control switching transistors V166 and V167 of the push-pull converter via the driver in integrated circuit N12.

The voltage of ± 30 V for the TTY line current is generated from the 5.3-VDC supply voltage by means of the push-pull converter consisting of switching transistors (VMOS field effect transistors) V166, V167, transformer T1, rectifier bridge V168 to V171 and chokes L6, L7.

The 5.3-VDC voltage is chopped by means of clocked switching transistors V166, V167 in combination with the primary winding of transformer T1.

CONTROL UNIT • GB 853C1

Repair Manual • Description of Function

The AC voltage thus generated is then transformed and rectified in bridge circuit V168 to V171. The energy of the +30-V voltage is stored in choke L6 and the energy of the -30-V voltage in choke L7. The voltages are decoupled at lead-through filters Z2 and Z4 and forwarded to the line current circuits.

In transmission (line current) the signals from the connected teletyper with line current connection are forwarded to the line current circuit via contacts X51.A5, .A6.

In the current drain, consisting of transistors V149, V150, pulse forming to single current (60 V/40 mA) or double current pulses (± 30 V/ ± 20 mA) is carried out. The form of the pulse is set by means of jumpers X3/X31 and X3/X32. The voltage drop across resistor R161 in case of single current or across resistor R162 in case of double current is routed to the base of transistor V153. Together with transistors V156 and V154 transistor V153 forms the control circuit for optocoupler U1.3, .4, .13, .14.

The single or double current pulses at optocoupler output U1.13 are applied to contact X51.B7 via jumper X4/X41.1, .2, gate D3.1, .2, .3, driver N11.2, .15 and resistor R179.

In reception (line current) the TTY signals are forwarded via contact X51.B5 to amplifier N10.1, .2, .3, which then serves as a level-matching network.

A logic circuit, consisting of the gates of integrated circuits D3 and D4, enables the signal path to the following amplifier N10.13, .14, .15. This is only possible if contact X51.A23 is switched to ground via the FSK switch (S3, display board), position "Rx" and if there are no carrier activation signals available at gate inputs D3.13 and D4.5.

When the signal path is enabled, the TTY signals are forwarded from amplifier output N10.13 to the line current circuit.

The TTY signals are forwarded via optocoupler U1.1, .2, .15, .16 to the base of transistor V134 and via optocoupler U1.5, .6, .11, .12 to the base of transistor V133. The anti-phase signals are then amplified. The respective transistors V139 and V132 following V134 and V133 form the current drain or current source for the line current circuit.

The single current or double current pulses are formed by means of jumpers X2/X21 and X2/X22. These pulses are sent to contacts X51.A7, .A8.

In transmission (V.28 interface) the signals from the connected teletyper with V.28 interface are forwarded via contact X51.A9 to amplifier N10.5, .6, .7. This amplifier then serves as level-matching network. From amplifier output N10.5 the TTY signals are applied to contact X51.B7 via jumper X4/X41.2, .3, gate D3.1, .2, .3, driver N11.2, .15 and resistor R179.

In reception (V.28 interface) the TTY signals are forwarded via contact X51.B5 to amplifier N10.1, .2, .3. This amplifier then serves as level-matching network and is followed by a logic circuit. The latter, consisting of the gates of integrated circuits D3 and D4, enables the signal path to the following amplifier N10.13, .14, .15 (see reception, line current).

When the signal path is enabled, the TTY signals are forwarded from amplifier output N10.13 via gate D3.8, .9, .10, driver N11.3, .14 and resistor R137 to contact X51.A10.

CONTROL UNIT • GB 853C1

Repair Manual • Description of Function

5.4 Filter Board

(See circuit diagram 649.4157.01S)

The assemblies of the filter board prevent interfering signals from entering the control unit via the lines of the externally connected loud-speaker, the Morse key or the headphones.

The filter board contains connectors X31, X32 and X33, eight EMC filters designed in T- or II circuitry and lead-through filters Z1 to Z8.

Connectors X32 and X33 mounted to the front panel are switched in parallel. Via the connected EMC filters and the lead-through filters the transmission of AF signals, + 6-VDC supply voltage for the microphone and switching processes, e. g. "Transmit" is carried out.

Connector X31 forms the interface of the filter board and the assemblies of the control unit.

5.5 Keyboard PCB

(See circuit diagram 649.4111.01S)

All the information required for operation is entered into the control unit via the keyboard of the keyboard PCB.

The keyboard PCB consists of the keyboard with keyboard contacts and connector X11.

Upon key activation a connection is established between one contact of contacts X11. 2, .4, .6, .10 and one contact of contacts X11.1, .3, .5, .7, .12, .14, .16. Via the respective connection the call-up signal is transmitted to the processor board.

5.6 Display Board

(See circuit diagram 649.5676.01S)

The display board incorporates a nine-digit LC display and two LEDs as well as the assemblies required for driving these indicators. Furthermore, control mode switch S2, FSK switch S3 and OPERATION MODE switch S4 are also located on the display board.

LC display P1 is driven by means of a 4-bit address bus and a 4-bit data bus.

The 4-bit addresses are forwarded from contacts X21.A13, .A14, .B13, .B14 to inputs D1 to D4 of the 4-to-16 decoder D5, which decodes the applied address information and applies the valid address to the address bus. The address enables one of the 7-segment drivers D10 to D18 or one of the 4-segment drivers D3, D19 to D23 via the S inputs of these drivers.

The 4-bit data are applied to the data bus via contacts X21.A11, .A12, .B11, .B12. The 4-bit data are taken over by the segment driver previously enabled by the address information.

The respective segment driver D10 to D18 triggers the digital display on the LC display via outputs a to f. The respective segment driver D3, D19 to D23 triggers the alphanumeric information on the LC display via outputs Q1 to Q4.

The dot segments are driven by segment driver D3 at LC-display contacts P1.5, .22, .30, .37, .42. The back-plane connectors P1.1, .46 are also driven by segment driver D3.

In case of error messages, an "E" is indicated in the 10-MHz segment of the LC display. In this case segment driver D10 is addressed by the processor board and the binary information "1010" is applied to the 8-bit data bus.

Simultaneously, the signal "Display E" is forwarded from contact X21.A9 via transistor V3 to three EXOR gates of integrated circuit D1. The gates cause the signals at LC display inputs P1.61, .13, .56 to become inverted. Thus the message "E" is output.

A rectangular signal which is generated by astable multivibrator D2 is applied at the DF inputs (STROBE) of the segment drivers. This signal serves as clock for the segment drivers. The frequency of 100 to 150 Hz is determined by RC network R24, C1 at contacts D2.1, .2, .3.

CONTROL UNIT • GB 853C1

Repair Manual • Description of Function

LED H1 "HF" indicates whether HF power is emitted. The LED is driven by segment-driver output D19.4 via EXOR gate D1.1, .2, .3 and transistor V4.

LED H2 "SQUELCH" indicates whether a squelch signal is generated on the audio board. The LED is driven by contact X21.B7 via transistor V5.

The illumination unit consisting of LEDs H12 to H21 serves for indirect illumination of the LC display.

Via connector X22 potentiometers R1 "VOLUME", R2 "SQUELCH", loudspeaker B1 and switch S1 are connected to the display board. These components are incorporated in the front panel of the control unit.

5.7 Motherboard

(See circuit diagram 649.4011.01S)

The motherboard contains five connectors and transformer T1.

The printed circuit boards of the control unit are interconnected via connectors X21, X31, X41, X51 and tracks on the motherboard. Connector X61 is used for connection of the control unit to the radio set and, if required, to the teletyper.

Transformer T1 matches the headphones operated via the filter board (contacts X31.B2, .B3) to outputs X51.B28 and X51.A22 on the audio board.

CONTROL UNIT • GB 853C1

Repair Manual • Configuration

5.8 Configuration

5.8.1 Switch S1 (Processor Board)

Baud Rate	Switch Position			
	4	3	2	1
110	0	0	0	0
200	0	0	0	1
300	0	0	1	0
600	0	0	1	1
1200	0	1	0	0
2400 *	0	1	0	1
4800	0	1	1	0
9600	0	1	1	1
ext. clock	1	X	X	X

0 = open, 1 = closed, X = arbitrary

5.8.3 Jumpers X21, X22, X31, X32 (Audio Board)

Jumper X	Single Current	Double Current
X21	1 - 2 *	2 - 3
X22	5 - 6 *	4 - 5
X31	1 - 2 *	2 - 3
X32	5 - 6 *	4 - 5

5.8.4 Jumper X41 (Audio Board)

Jumper	Line Current	V.28
X41	1 - 2 *	2 - 3

5.8.2 Jumpers X104.1 to X104.9 (Processor Board)

Note:

Bus operation given in the table below is not provided for the control unit.

Jumper X	Connection A - B	Connection B - C
104.1	test mode	normal operation *
104.2	ALE active *	ALE separated
104.3	external clock	internal clock *
104.4	V.28 / V.10	S2 On *
104.5	V.28 *	V.10 / V.11
104.6	V.11 / bus	V.28 / V.10 *
104.7	bus	V.11 / D1 = - 5 VDC *
104.8	storage blocked	storage not blocked *
104.9	software "Carrier Activation Off" *	software "Carrier Activation On"

* set ex works

CONTROL UNIT • GB 853C1

Repair Manual • Spare Parts

6. Repair

(See circuit diagrams, parts lists and components layouts in the appendix to this repair manual.)

6.1 Preliminary Remarks

6.1.1 General

The repair of the Control Unit GB 853C1 consists of troubleshooting and fault elimination.

Troubleshooting consists of a visual inspection, of measurements, alignment and functional checks. Fault elimination comprises the replacement of assemblies and components.

All the information required for repairing the Control Unit GB 853C1 down to component level is given in this chapter 6.

6.1.2 Restoring the Nominal Characteristics

Any component that is definitely proved to be defective - through use of the troubleshooting flowchart or by performing the measurements and functional checks - should only be replaced by a component that meets the specifications given in the respective parts list in the appendix to this repair manual.

Only in this way can the technical data be guaranteed that are given in chapter 1 of the user manual.

6.1.3 Spare Parts

All components and assemblies are subjected to strict quality control.

For components from outside suppliers, e.g. resistors, capacitors, diodes, transistors and integrated through to highly integrated circuits, R&S have set down their own delivery specifications for the purpose of ensuring maximum reliability. For this reason we recommend that only original spare parts be used to replace defective components.

When ordering a spare part, please state the following:

Type, ordering code and serial number of equipment, identification number of the parts list and designation, plus stock number of the component concerned.

All of these details are to be found in the circuit diagrams, parts lists and components layouts attached to this manual.

CONTROL UNIT • GB 853C1

Repair Manual • Important User Information

6.1.4 Important User Information

Please note the following points, which are important for the avoidance of misunderstandings when using part 6 of the repair manual:

- The troubleshooting must be carried out in the order given.
 - Perform all measurements or functional checks, during which the supply voltages are switched on, with the correct operating values.
 - Switch on the supply voltages and measuring levels acc. to the order given as follows:
 1. Negative supply voltages
 2. Positive supply voltages and
 3. Measuring levels.
- The unit is to be switched off in the reverse order to that above.
- All measurements are referred to ground, if not stated otherwise.
 - The abbreviations given in the text e.g. X51.A7 or D10.6 are to be understood as follows:
 - Connector X51, contact A7 or
 - Integrated circuit D10, contact 6.
 - Disassemble the unit only to the extent necessary to eliminate all faults.
 - Make sure the supply voltage is switched off before carrying out any soldering on any component.

CAUTION ESD

Among the components incorporated in the unit there are electrostatic sensitive devices (ESD). Devices of this kind are extremely sensitive to high extraneous voltages. Static discharge can produce very high voltage spikes, which are capable of destroying these devices.

For this reason, when work is being carried out in the vicinity of these devices, i.e. unless a special CMOS work station is available, the following minimum requirements should be observed:

- Conductive bench and floor covering
- Chair or stool with conductive covering
- Grounded, metallic working top and conductive wrist-straps with a resistance of $> 200 \text{ k}\Omega$, $< 1 \text{ M}\Omega$ plus an insulated lead and plug
- Soldering irons with safety grounding
- All conductive surfaces, wrist-straps and working tops must be interconnected by insulated leads.

CONTROL UNIT • GB 853C1

Repair Manual • Test Equipment and Special Tools

6.2 Test Equipment and Special Tools

The test equipment and special tools given in the following list will be required for performing the repairs described in this part of the manual. Equivalent items of test equipment can be used. Special tools are not required.

No.	Test equipment, required data	Test equipment recommended by R&S	Ordering code
1	Digital Multimeter (2 devices) 1 μ V to 1000 V / 100 nA to 1.6 A / - 6 dBm to 0 dBm / 0 to 10 M Ω	UDL 45	1037.1507.02
2	Frequency counter 10 MHz, sensitivity 1 mV	Conventional workshop model	-
3	Oscilloscope 0 to 10 MHz	Conventional workshop model	-
4	Power supply (5 devices) 0 to 20 VDC, 0 to 2 A	Conventional workshop model	-
5	AF Generator - AF Generator 10 Hz to 1 MHz, R _i : 5 Ω , 150 Ω , 600 Ω - Sweep Generator	SPN SWP	336.3019.02 339.0010.02
6	Load resistors - 600 Ω / 0.25 W - 150 Ω / 0.5 W - 50 Ω / 0.5 W - 5 Ω / 10 W	Conventional workshop models	-
7	Potentiometer 5 k Ω / 0.25 W, linear	Conventional workshop model	-
8	AF Millivoltmeter - 31dBm to + 4 dBm, 100 Hz to 1 MHz	FAM	334.2015.54
9	Loudspeaker 10 W / 5 Ω	Conventional workshop model	-
10	TTL level converter \pm 5 V	Conventional workshop model	-
11	Digital tester	Conventional workshop model	-

CONTROL UNIT • GB 853C1

Repair Manual • Troubleshooting

6.3 Troubleshooting

6.3.1 General

Troubleshooting comprises a visual inspection and, if necessary, checks of electrical assemblies and components acc. to the troubleshooting flowcharts, Figs 6.1 to 6.8, as well as the elimination of faults.

To make the troubleshooting flowchart clearer and more understandable, references to other checks and repair work are given where necessary.

To enable the electrical troubleshooting and repair work to be carried out as rationally and speedily as possible, the order of the tests should be followed as presented here.

6.3.2 Visual Inspection

If there is a disturbance in the equipment, first perform a visual inspection:

1. Disassemble the control unit acc. to 6.5.

2. Check the connectors for bent, corroded or broken contacts. Replace the defective connectors acc. to 6.5.

CAUTION

If a contact is discoloured, the connector and the mating connector will both be damaged and must be replaced.

3. Check the printed circuit boards for discolouration. Replace the circuit board(s) acc. to 6.5 if there is any discolouration.
4. Replace burnt or burst components acc. to 6.5.
5. Check lead-through filters Z1 to Z8 on the filter board as well as Z1 to Z6 on the audio board for hairline cracks and other defects.

If, during visual inspection, serious damage, especially on a printed circuit board, is found, we recommend to replace the entire PCB.

CONTROL UNIT • GB 853C1

Repair Manual • Troubleshooting

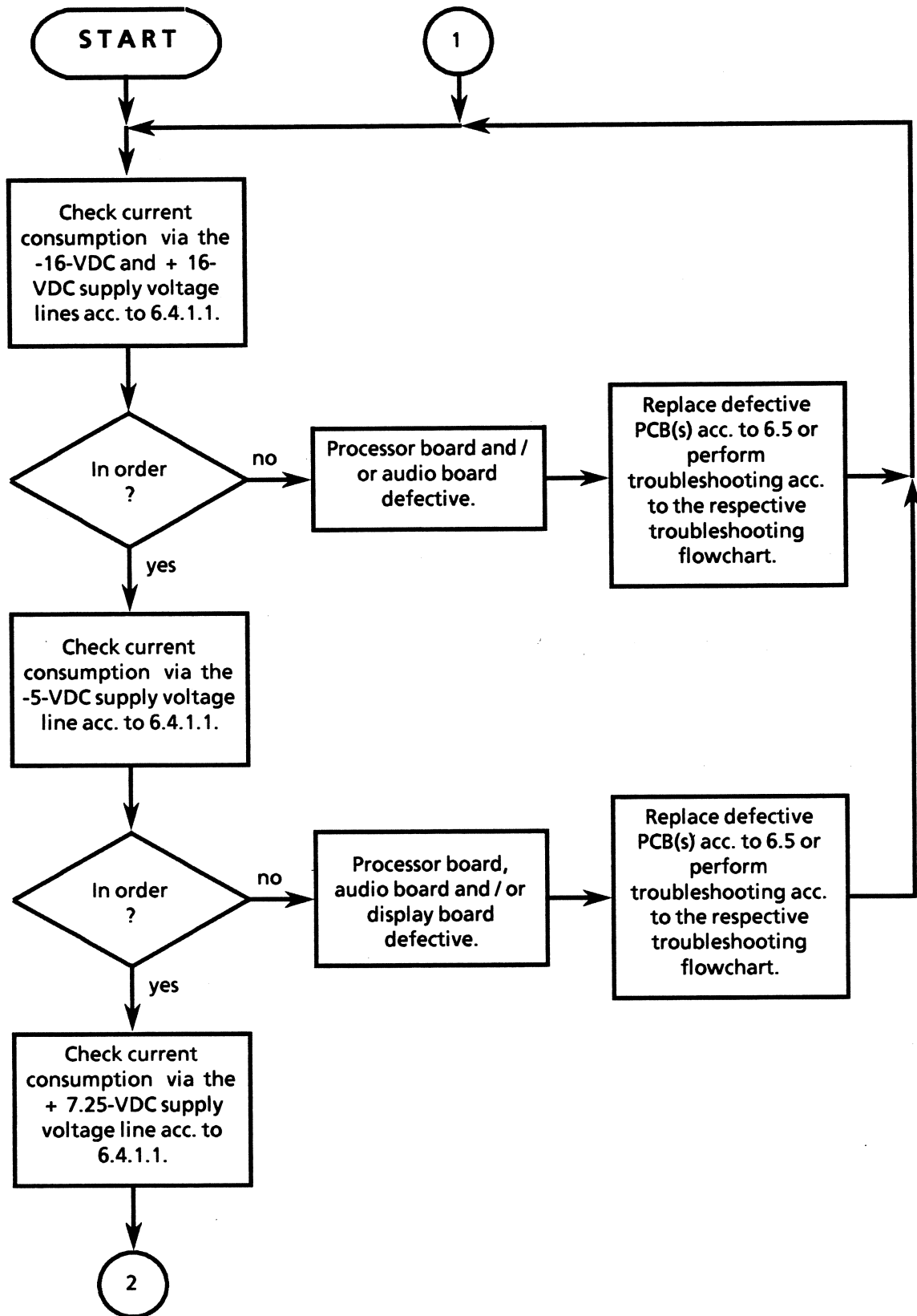

Fig. 6.1 Troubleshooting Flowchart, Control Unit GB 853C1 (page 1 of 2)

CONTROL UNIT • GB 853C1

Repair Manual • Troubleshooting

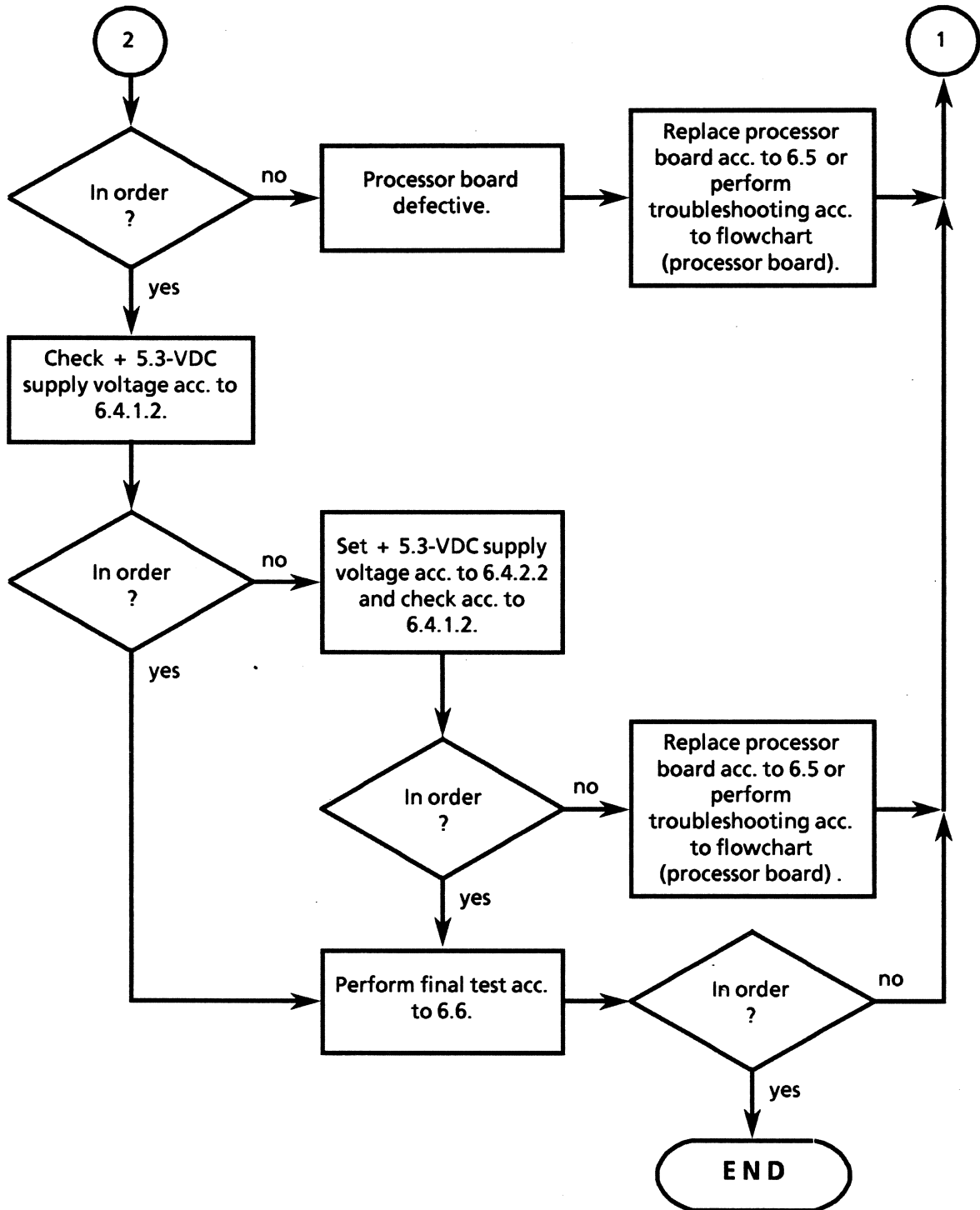

Fig. 6.1 Troubleshooting Flowchart, Control Unit GB 853C1 (page 2 of 2)

CONTROL UNIT • GB 853C1

Repair Manual • Troubleshooting

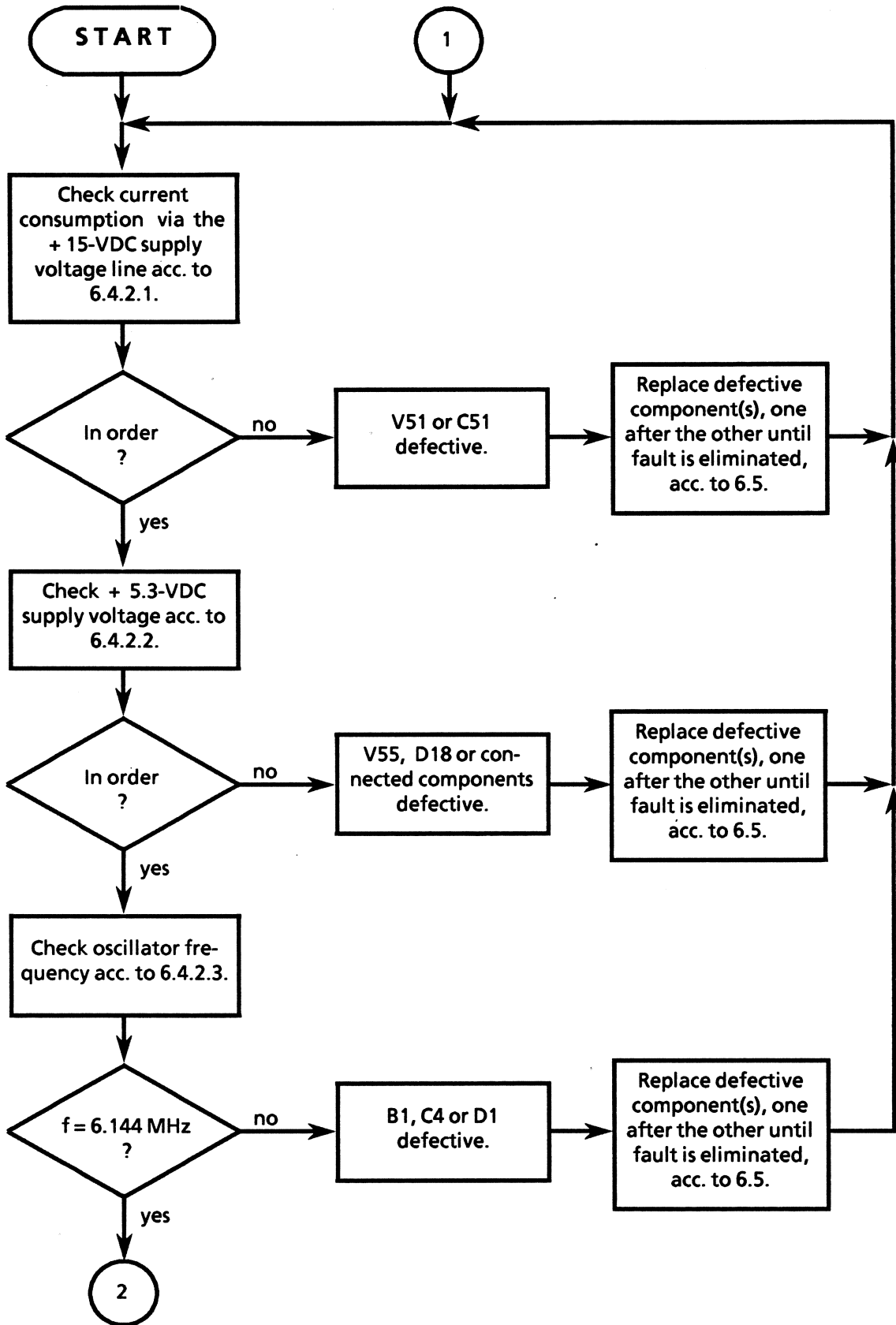

Fig. 6.2 Troubleshooting Flowchart, Processor Board (page 1 of 2)

CONTROL UNIT • GB 853C1

Repair Manual • Troubleshooting

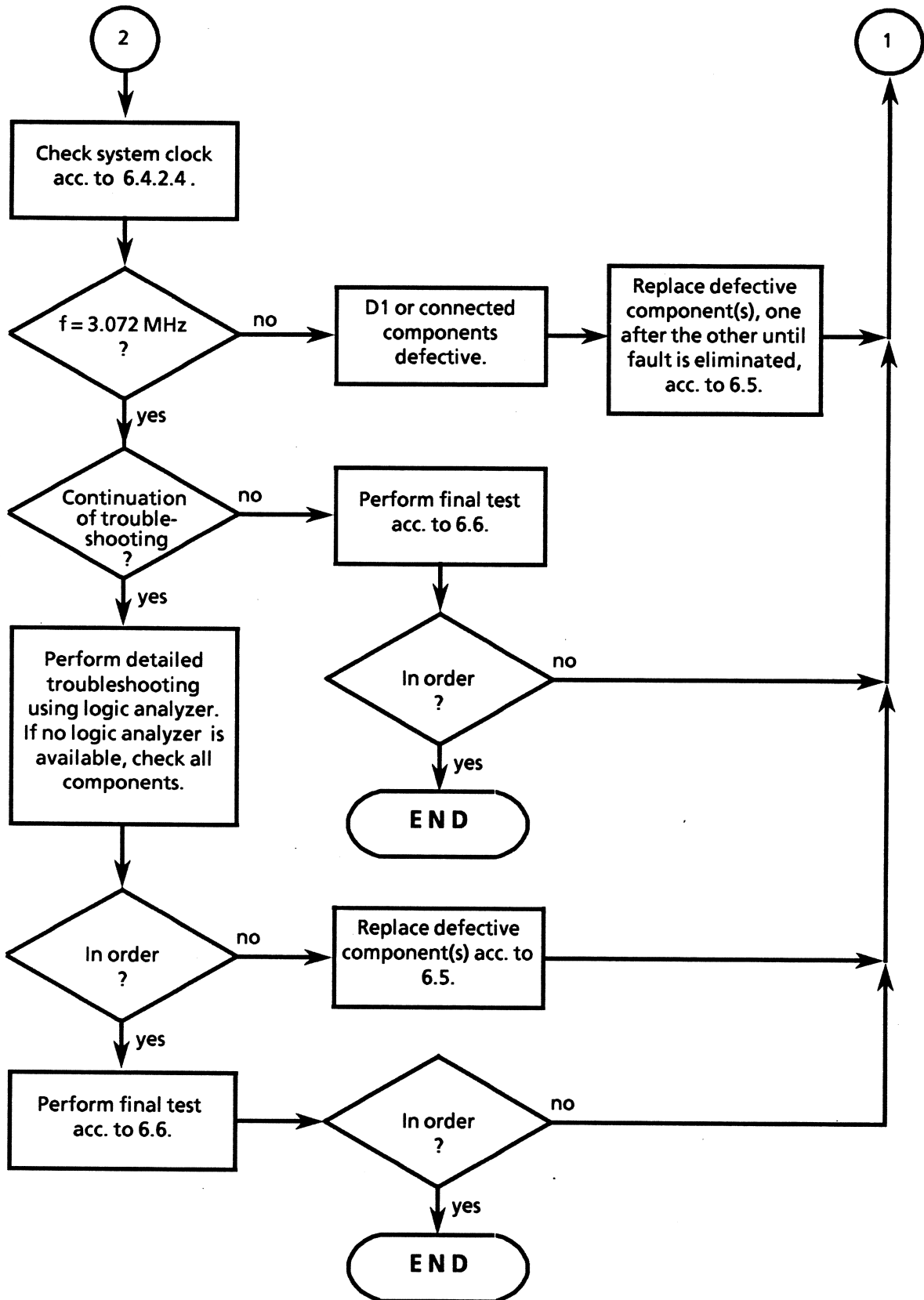

Fig. 6.2 Troubleshooting Flowchart, Processor Board (page 2 of 2)

CONTROL UNIT • GB 853C1

Repair Manual • Troubleshooting

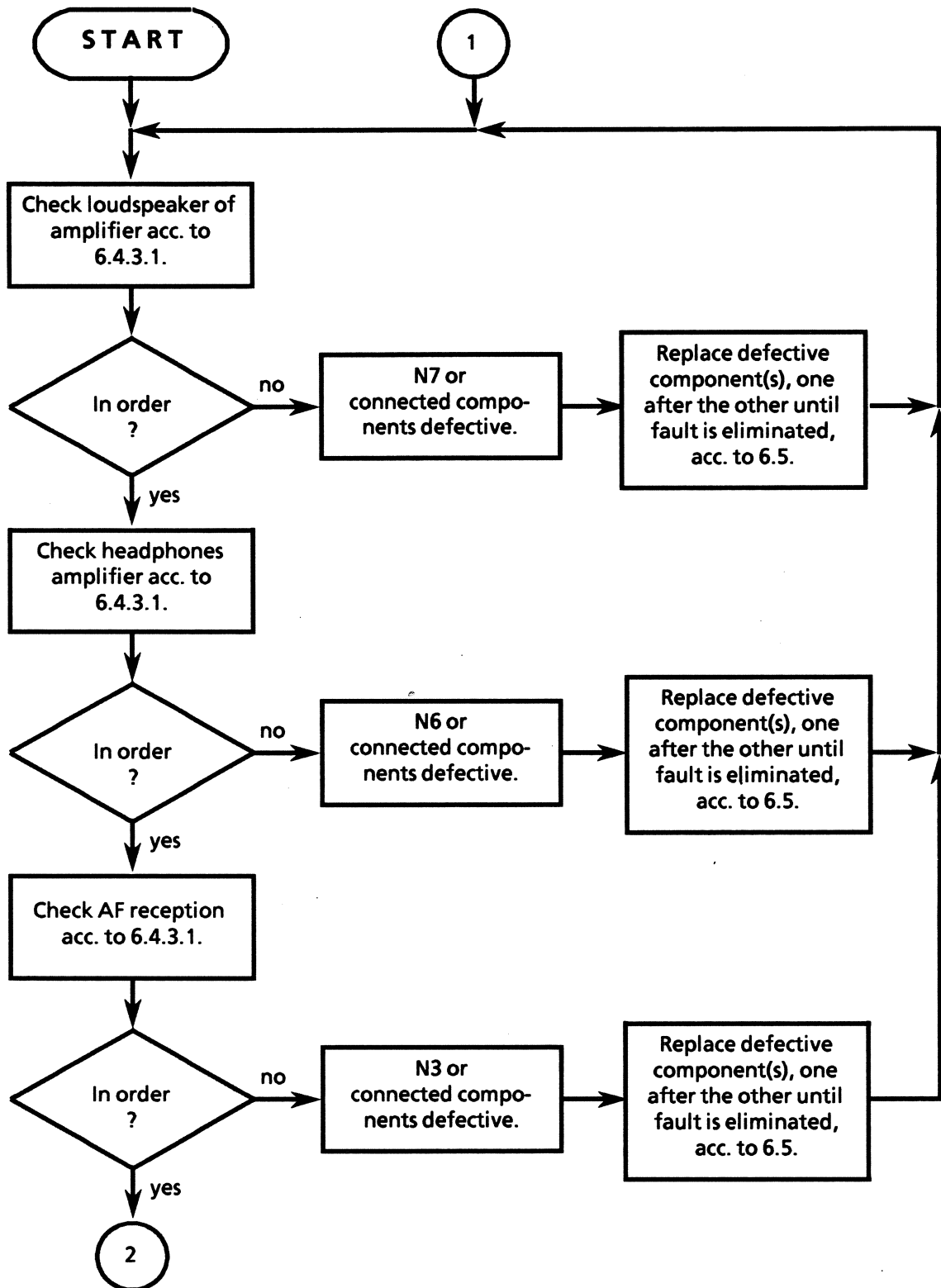

Fig. 6.3 Troubleshooting Flowchart, Audio Board, AF Section (page 1 of 3)

CONTROL UNIT • GB 853C1

Repair Manual • Troubleshooting

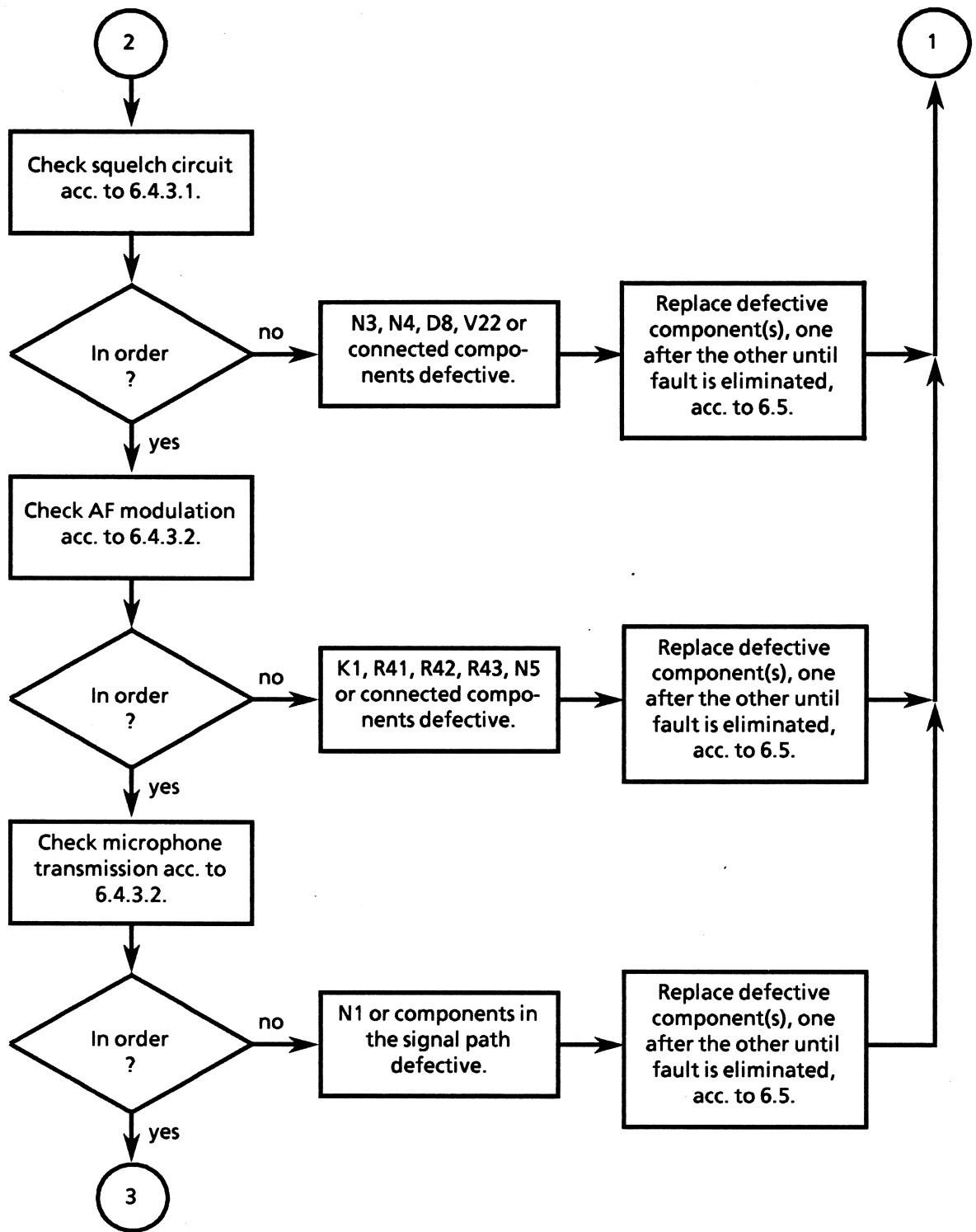

Fig. 6.3 Troubleshooting Flowchart, Audio Board, AF Section (page 2 of 3)

CONTROL UNIT • GB 853C1

Repair Manual • Troubleshooting

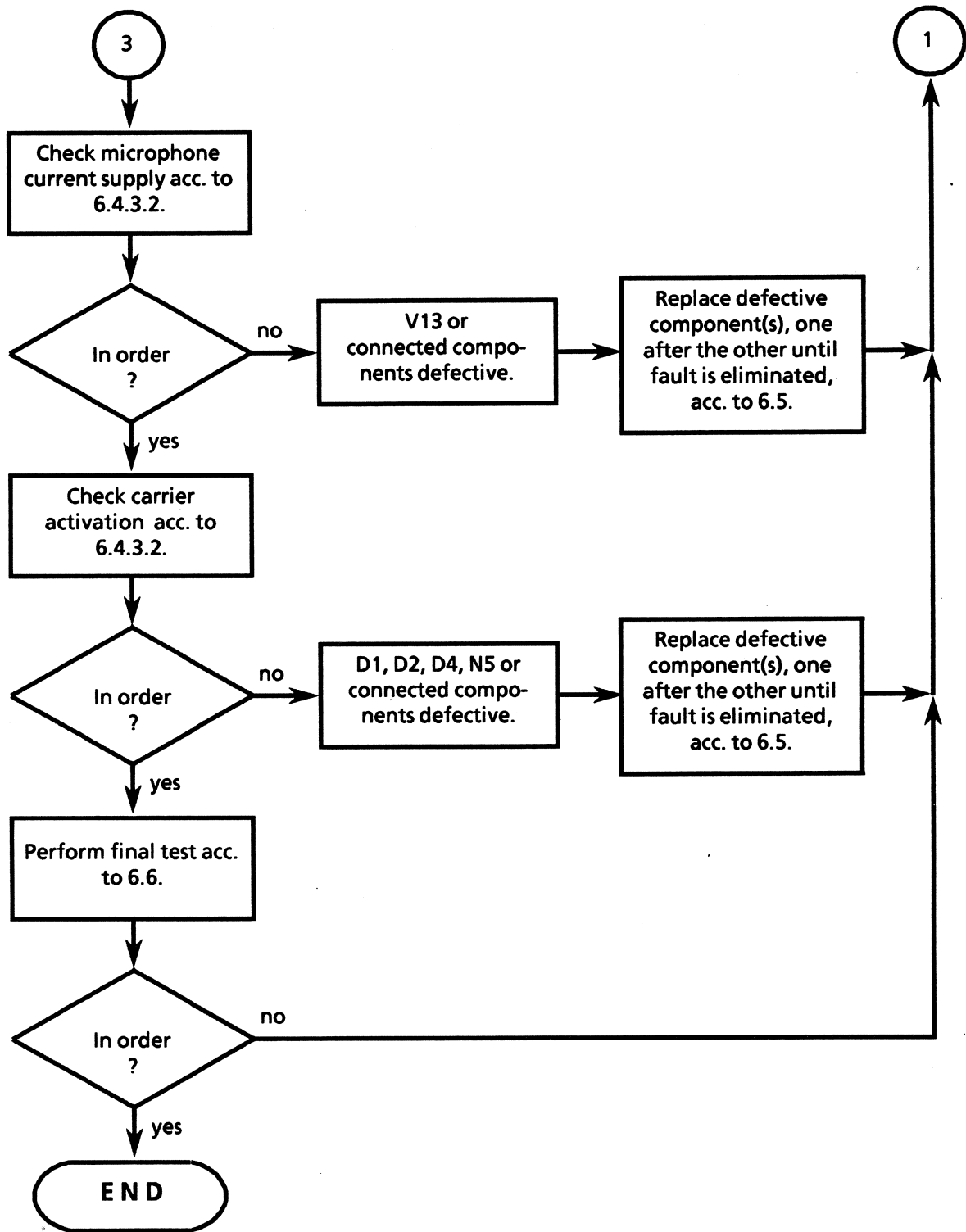

Fig. 6.3 Troubleshooting Flowchart, Audio Board, AF Section (page 3 of 3)

CONTROL UNIT • GB 853C1

Repair Manual • Troubleshooting

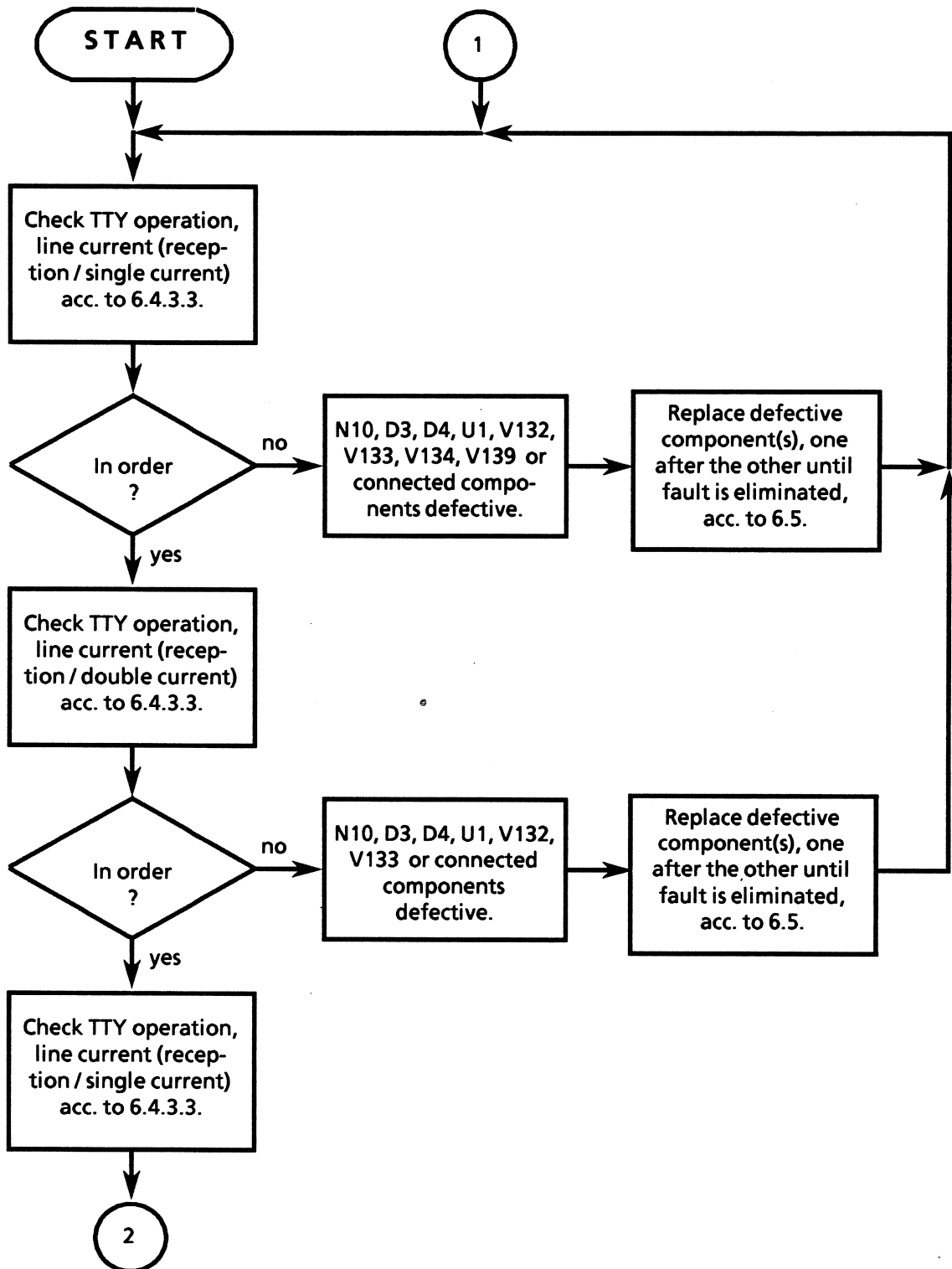

Fig. 6.4 Troubleshooting Flowchart, Audio Board, FSK Section (page 1 of 3)

CONTROL UNIT • GB 853C1

Repair Manual • Troubleshooting

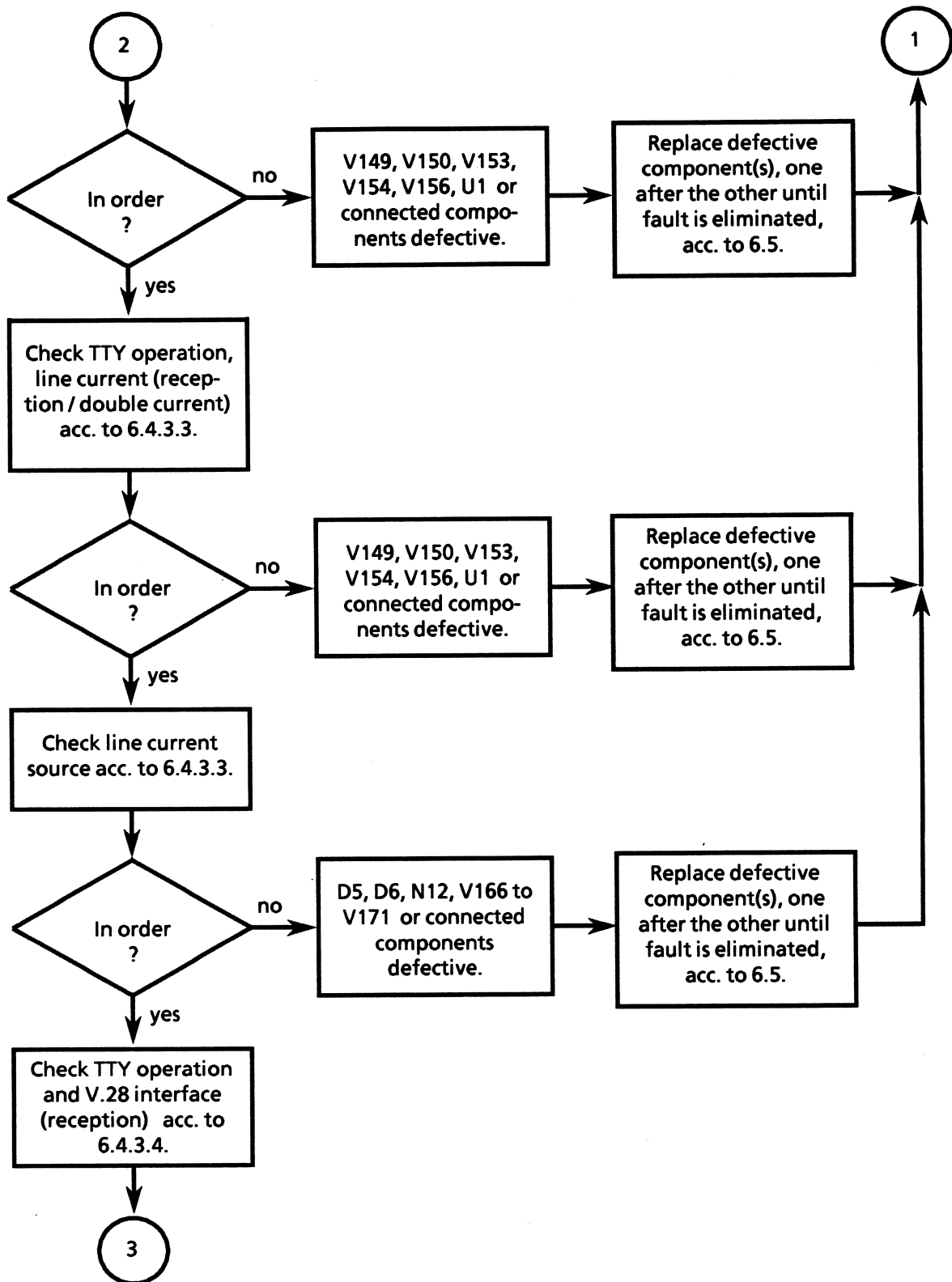

Fig. 6.4 Troubleshooting Flowchart, Audio Board, FSK Section (page 2 of 3)

CONTROL UNIT • GB 853C1

Repair Manual • Troubleshooting

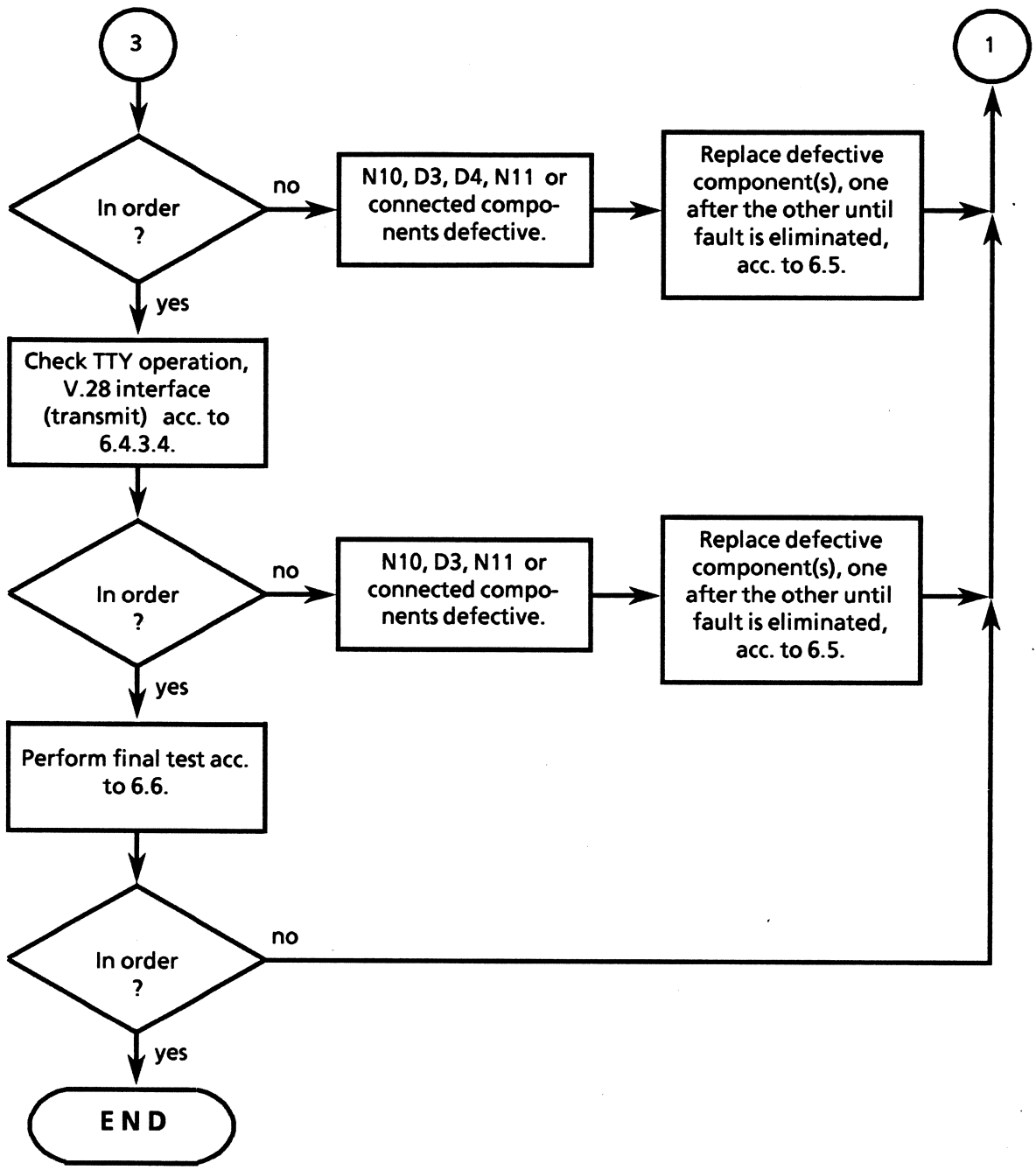

Fig. 6.4 Troubleshooting Flowchart, Audio Board, FSK Section (page 3 of 3)

CONTROL UNIT • GB 853C1

Repair Manual • Troubleshooting

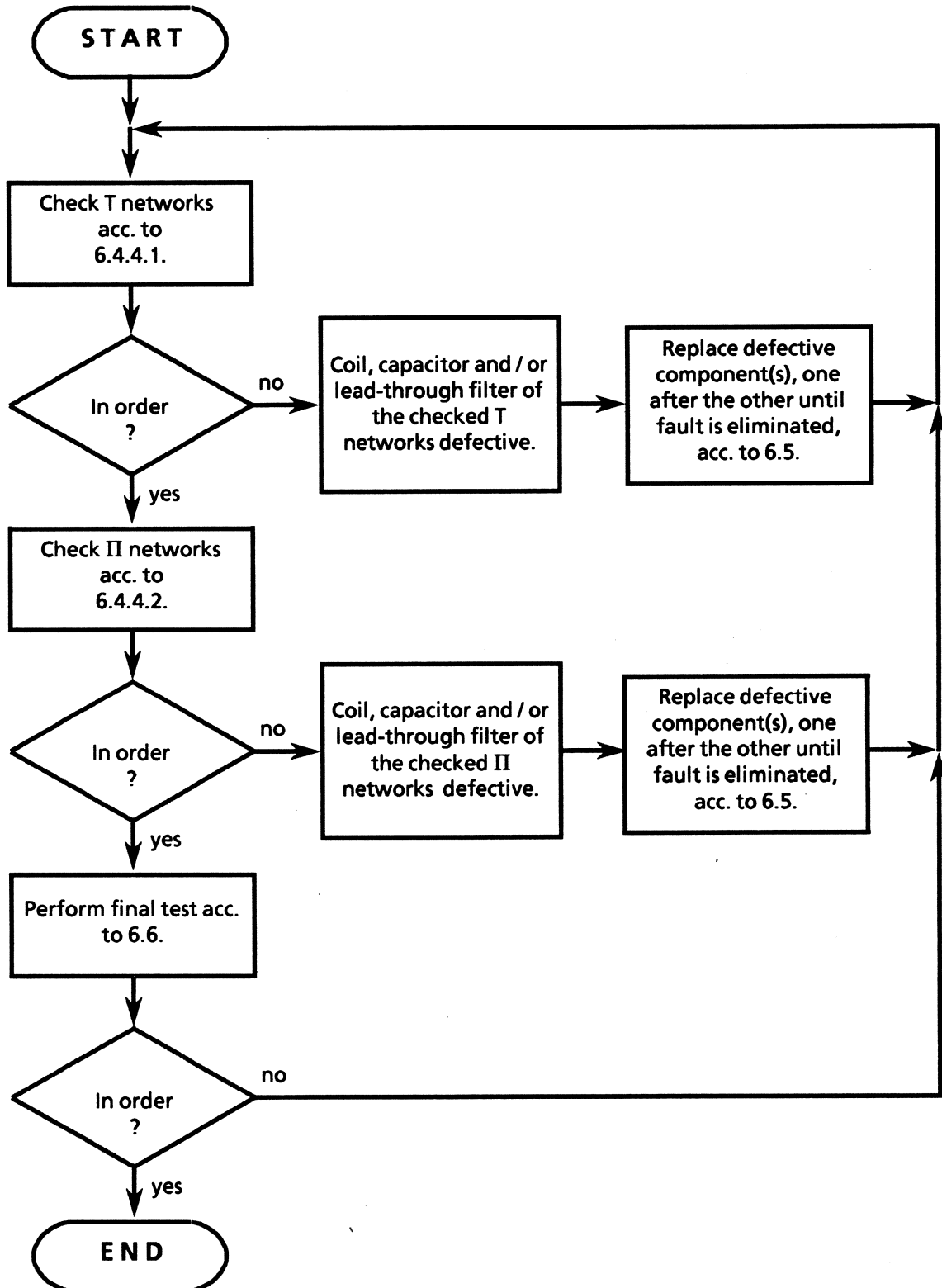

Fig. 6.5 Troubleshooting Flowchart, Filter Board

CONTROL UNIT • GB 853C1

Repair Manual • Troubleshooting

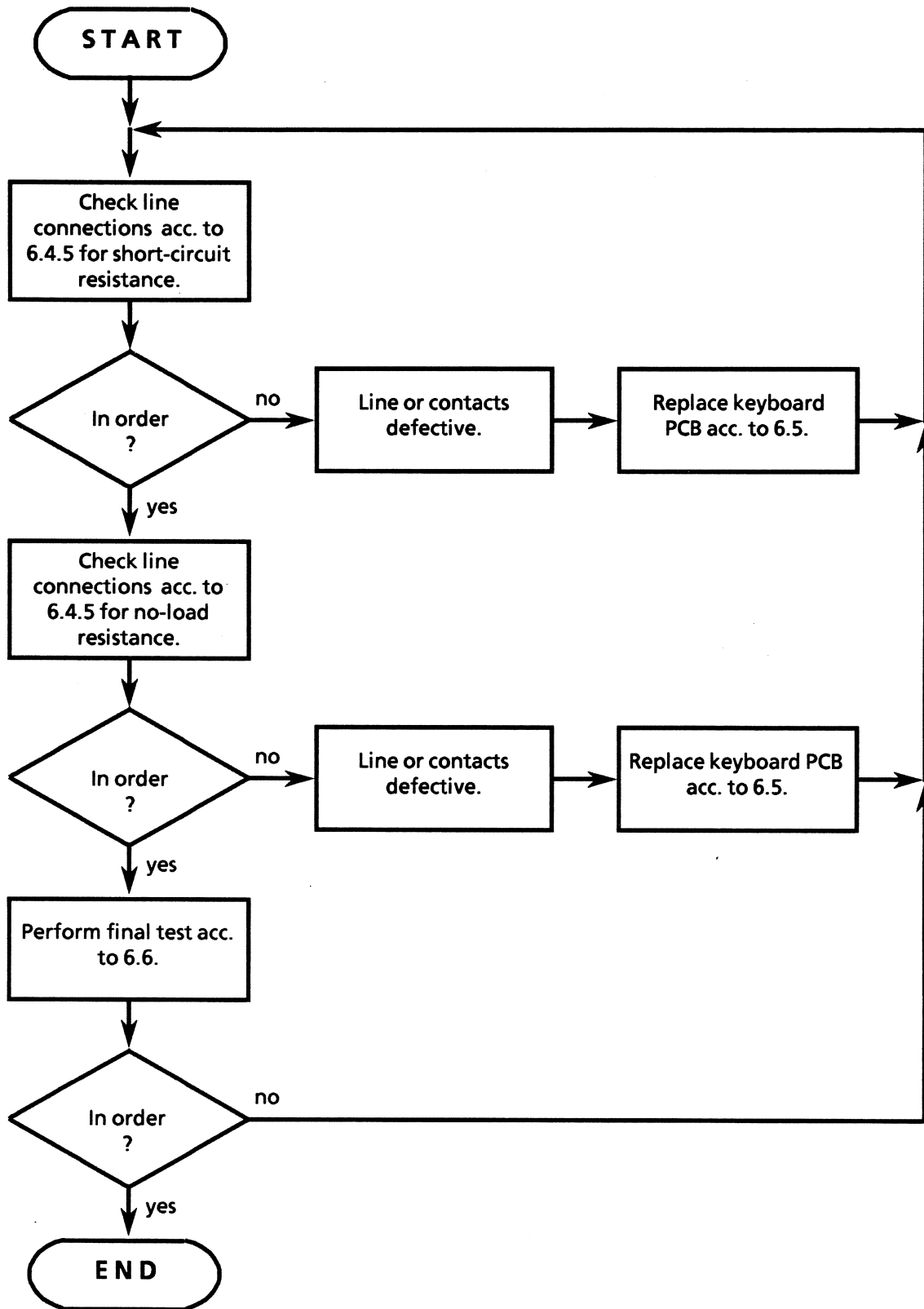

Fig. 6.6 Troubleshooting Flowchart, Keyboard PCB

CONTROL UNIT • GB 853C1

Repair Manual • Troubleshooting

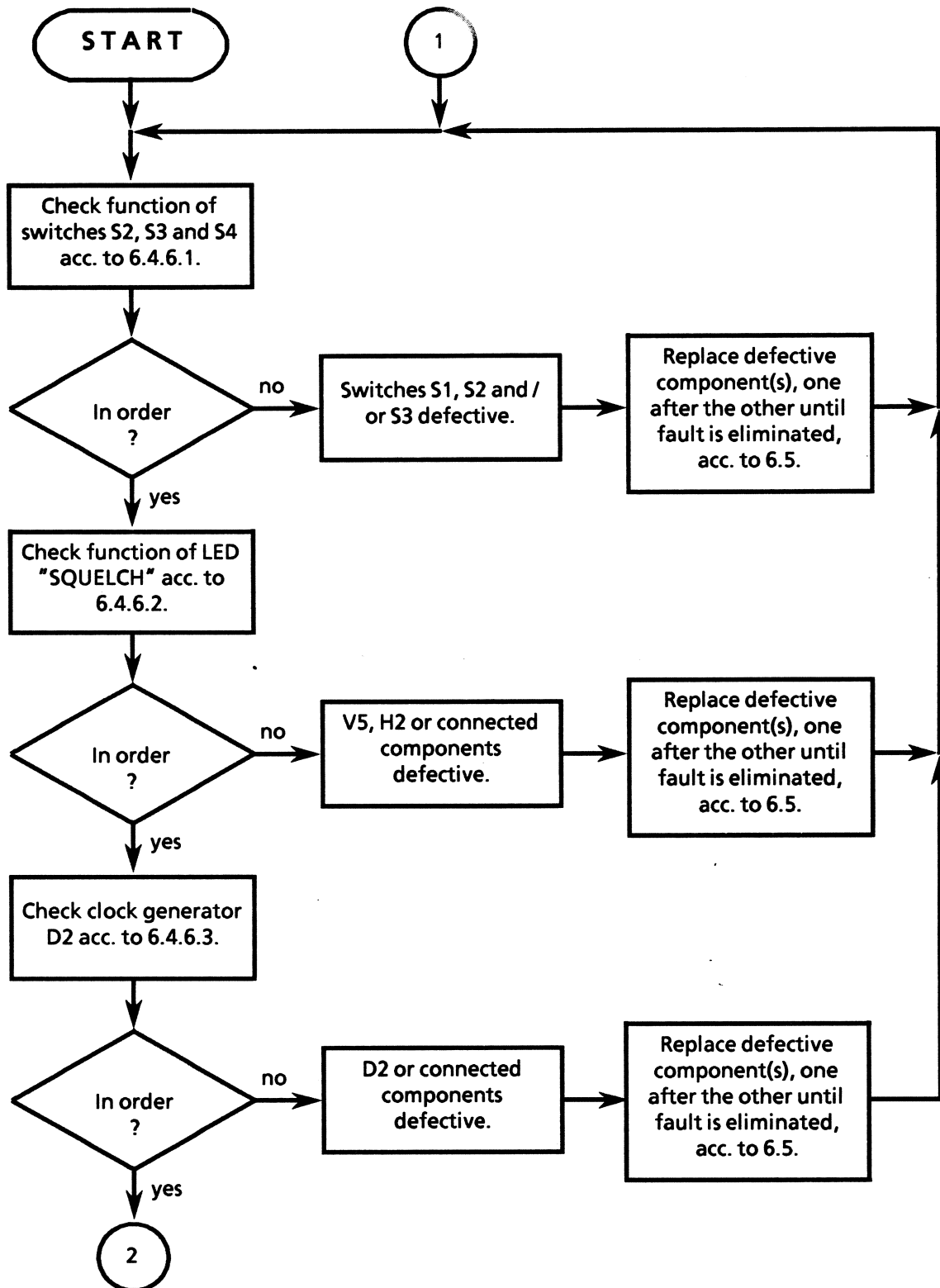

Fig. 6.7 Troubleshooting Flowchart, Display Board (page 1 of 2)

CONTROL UNIT • GB 853C1

Repair Manual • Troubleshooting

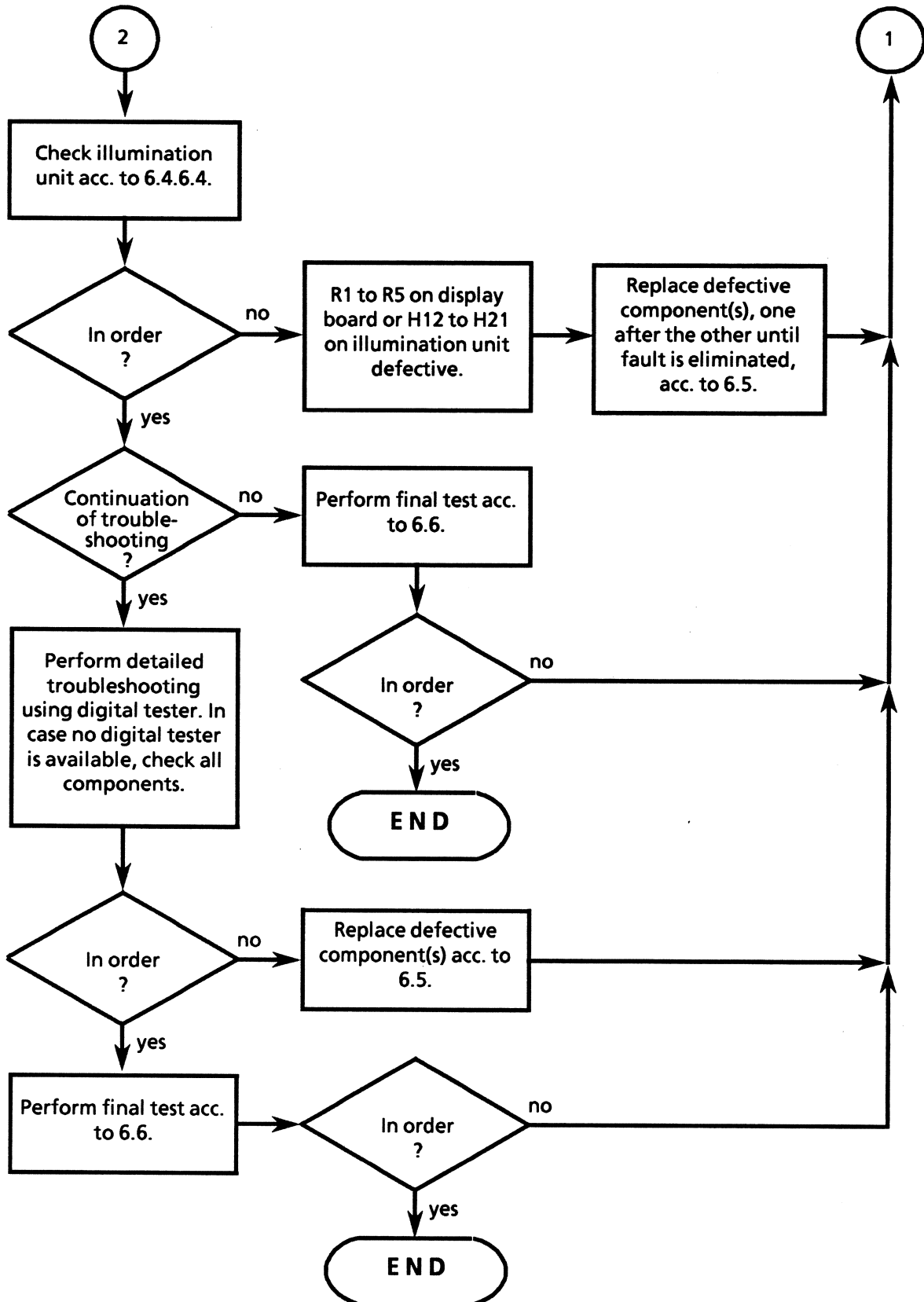

Fig. 6.7 Troubleshooting Flowchart, Display Board (page 2 of 2)

CONTROL UNIT • GB 853C1

Repair Manual • Troubleshooting

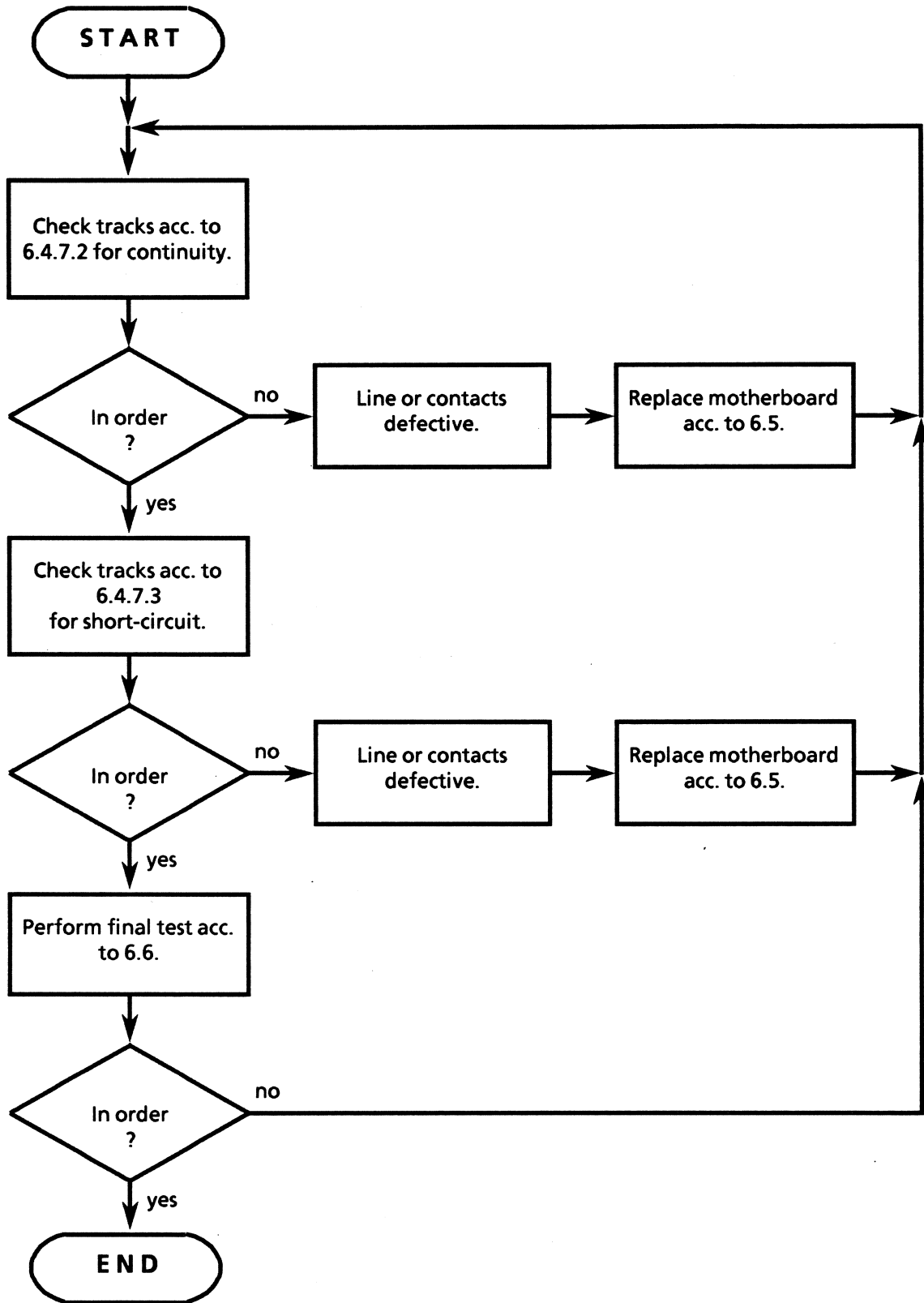

Fig. 6.8 Troubleshooting Flowchart, Motherboard

CONTROL UNIT • GB 853C1

Repair Manual • Measurements and Functional Checks

6.4 Measurements, Alignment and Functional Checks

The measurements and functional checks described below are the more detailed procedures to the instructions given in condensed form in the troubleshooting flowcharts. Consequently these measurements and functional checks are usually undertaken by branching out of the troubleshooting flowcharts at a particular point.

When the measurement etc. has been performed, return to the troubleshooting and continue at the same point where it has been left.

If a fault has been clearly identified beforehand, however, one can of course commence with one of these measurements etc. directly.

6.4.1 Power Supply

6.4.1.1 Check of Current Consumption

1. Arrange test set-up acc. to Fig. 6.9.
2. Connect digital multimeter (ammeter) to + 16-VDC power supply and contacts X61.A2 and X61.B2.
3. Switch on test equipment.
4. On AF generator set a frequency of 1 kHz, an internal resistance of 600 Ω and an output level of - 6 dBm.
5. On the front panel of the control unit turn potentiometer "VOLUME" fully clockwise and potentiometer "SQUELCH" fully counter-clockwise.
6. Check current consumption using digital multimeter (ammeter).
Nominal value: < 500 mA
7. Switch off power supply units.
8. Connect digital multimeter (ammeter) to - 16-VDC power supply and contact X61.A5.
9. Switch on power supply units.
10. Check current consumption using digital multimeter (ammeter).
Nominal value: < 30 mA
11. Switch off power supply units.
12. Connect digital multimeter (ammeter) to - 5-VDC power supply and contact X61.B5.
13. Switch on power supply units.
14. Check current consumption using digital multimeter (ammeter).
Nominal value: < 50 mA
15. Switch off power supply units.
16. Connect digital multimeter (ammeter) to + 7.25-VDC power supply and contacts X61.A3 and X61.B3.
17. Switch on power supply units.
18. Check current consumption using digital multimeter (ammeter).
Nominal value: < 800 mA
19. Switch off test equipment.

6.4.1.2 Check of + 5.3-VDC Supply Voltage

1. Arrange test set-up acc. to Fig. 6.9.
2. Connect digital multimeter (voltmeter) to contacts X61.A4 and X61.B4.
3. Switch on test equipment.
4. On AF generator set a frequency of 1 kHz, an internal resistance of 600 Ω and an output level of - 6 dBm.

CONTROL UNIT • GB 853C1

Repair Manual • Measurements, Alignment and Functional Checks

5. On the front panel turn potentiometer "VOLUME" fully clockwise and potentiometer "SQUELCH" fully counter-clockwise.
6. Check supply voltage using digital multimeter.
Nominal value: +5.3 VDC
7. If necessary, set nominal value acc. to 6.4.2.2.
8. Switch off test equipment.

6.4.2 Processor Board

6.4.2.1 Check of Current Consumption

1. Arrange test set-up acc. to Fig. 6.10 and switch on test equipment.
2. Connect digital multimeter (ammeter) between + 16-VDC power supply and contact X41.A30 and check current consumption.
Nominal value: 100 + 50 mA
3. Connect digital multimeter (ammeter) between - 16-VDC power supply and contact X41.B29 and check current consumption.
Nominal value: 26 + 4 mA
4. Connect digital multimeter (ammeter) between - 5-VDC power supply and contact X41.A31 and check current consumption.
Nominal value: 20 + 30 mA
5. Connect digital multimeter (ammeter) between + 7.25-VDC power supply and contact X41.B30 and check current consumption.
Nominal value: 650 + 150 mA
6. Switch off test equipment.

6.4.2.2 Check of + 5.3-VDC Supply Voltage

1. Arrange test set-up acc. to Fig. 6.10 and switch on test equipment.
2. Connect digital multimeter (voltmeter) to contact X41.B31.
3. Check supply voltage using digital multimeter.
Nominal value: +5.3 - 0.15 VDC
4. If necessary, set nominal value with potentiometer R52.
5. Switch off test equipment.

6.4.2.3 Check of Oscillator Frequency

1. Arrange test set-up acc. to Fig. 6.10 and switch on test equipment.
2. Connect frequency counter to oscillator input X2 of CPU D1, contact D1.2.
3. Check crystal frequency with frequency counter.
Nominal value: 6.144 MHz
4. Switch off test equipment.

6.4.2.4 Check of System Clock

1. Arrange test set-up acc. to Fig. 6.10 and switch on test equipment.
2. Connect frequency counter to clock output CLK of CPU D1, contact 37.
3. Check system clock using frequency counter.
Nominal value: 3.072 MHz \pm 1.5 kHz
4. Switch off test equipment.

CONTROL UNIT • GB 853C1

Repair Manual • Measurements and Functional Checks

6.4.2.5 Check of Interrupt Request Pulses

1. Arrange test set-up acc. to Fig. 6.10 and switch on test equipment.
2. Connect frequency counter to output D9.10 of EXOR gate D9.
3. Check pulse width of low pulse (FSK-STBY interrupt request) using frequency counter.
Nominal value: $800 \pm 200 \mu\text{s}$
4. Connect frequency counter to output D9.4 of EXOR gate D9.
5. Check pulse width of low pulse (carrier activation interrupt request).
Nominal value: $800 \pm 200 \mu\text{s}$
6. Switch off test equipment.
6. Using digital multimeter (level meter) check level at contact X51.A22.
Nominal value: $\geq 30 \text{ dBm}$
Make a note of the measured value.
7. Vary the frequency in the frequency range of 300 to 3400 Hz and simultaneously check level deviation from the noted value (step 6) at contact X51.A22 using digital multimeter (level meter).
Nominal value: $\pm 0.5 \text{ dB}$
8. On AF generator set a frequency of 1 kHz and an output level of -6 dBm.
9. Connect digital multimeter (voltmeter) to contact X51.A24.
10. Turn squelch potentiometer fully clockwise.

6.4.3 Audio Board

6.4.3.1 Check of AF Reception

1. Arrange test set-up acc. to Fig. 6.11 and switch on test equipment.
2. On AF generator set a frequency of 1 kHz, an internal resistance of 600Ω and an output level of -6 dBm.
Check of Loudspeaker Amplifier
3. Turn squelch potentiometer fully counter-clockwise.
4. Using digital multimeter (voltmeter) check voltage at contact X51.A24.
Nominal value: $0.05 \text{ V (low level)}$
5. Using digital multimeter (voltmeter) check voltage at contact X51.A18.
Nominal value: $0.05 \text{ V (low level)}$
11. Using digital multimeter (voltmeter) check voltage at contact X51.A24.
Nominal value: $0.05 \text{ V (low level)}$ after approx. 1.5 s
12. Turn squelch potentiometer fully counter-clockwise.
13. Connect digital multimeter (voltmeter) to contact X51.A18.
14. Turn squelch potentiometer fully clockwise.
15. Using digital multimeter (voltmeter) check voltage at contact X51.A18
Nominal value: $0.05 \text{ V (low level)}$ after approx. 1.5 s
16. Using digital multimeter (level meter) check level at contact X51.A22.
Nominal value: $17 \pm 3 \text{ dB}$

CONTROL UNIT • GB 853C1

Repair Manual • Measurements and Functional Checks

17. Connect contact X51.A29 (loudspeaker switch-off) to contact X51.B10 (ground).
27. Turn squelch potentiometer fully counter-clockwise.
18. Using digital multimeter (level meter) check level at contact X51.A22.
Nominal value: > 20 dB
28. Using digital multimeter (voltmeter) check voltage at contact X51.A18.
Nominal value: 0.05 V (low level)

19. Interrupt connection between contacts X51.A29 and X51.B10.
29. Using digital multimeter (voltmeter) check voltage at contact X51.A24.
Nominal value: 0.05 V (low level)

Check of Headphones Amplifier

20. Turn squelch potentiometer fully counter-clockwise.
30. Turn squelch potentiometer fully clockwise.
21. Using digital multimeter (level meter) check level at contact X51.B28.
Nominal value: ≥ 17 dBm
31. Using digital multimeter (voltmeter) check voltage at contact X51.A18.
Nominal value: 4.95 V (high level)

22. Turn squelch potentiometer fully clockwise.
32. Using digital multimeter (voltmeter) check voltage at contact X51.A24.
Nominal value: 4.95 V (high level)

23. Using digital multimeter (level meter) check level at contact X51.B28.
Nominal value: 17 ± 3 dB
33. Turn squelch potentiometer to medium position until squelch opens.

Check of AF Reception

24. Using digital multimeter (level meter) check level at contact X51.A12.
Nominal value: 0.0 dBm + 0.35 / - 0.2 dB
34. Using digital multimeter (voltmeter) check voltage at contact X51.A24.
Nominal value: 0.05 V (low level)

Check of Squelch

25. Connect sweep generator to AF generator input "SWEEP". Switch on sweep generator.
35. From medium position turn potentiometer clockwise (approx. 1/6 of potentiometer range) until squelch closes.
Note:
Turn potentiometer slowly, as the squelch closes with a delay of approx. 1.5 s.
26. On sweep generator set a sweep frequency of 2 Hz, an internal resistance of 5Ω and an output voltage of 1 mV.
36. Using digital multimeter (voltmeter) check voltage at contact X51.A24.
Nominal value: 4.95 V (high level)

37. Switch off test equipment.

CONTROL UNIT • GB 853C1

Repair Manual • Measurements and Functional Checks

6.4.3.2 Check of AF Transmission

Check of AF Modulation

1. Arrange test set-up acc. to Fig. 6.12.
2. Connect AF generator to contact X51.A14.
3. Connect contact X51.B14 to ground (low level).
4. Switch on test equipment.
5. On AF generator set a frequency of 1 kHz, an internal resistance of 600 Ω and an output level of 0.0 dBm.
6. Using digital multimeter (level meter) check level at contact X51.A14.
Nominal value: 0.0 dBm + 0.25 / - 0.2 dB
7. Using digital multimeter (level meter) check level at contact X51.B9.
Nominal value: - 6.0 dBm + 1.0 dB
8. Disconnect contact X51.B14 from ground (high level).
13. Using digital multimeter (level meter) check level at contact X51.B9.
Nominal value: - 7.0 dBm + 1.5 dB
14. On AF generator set an output voltage of 775 mV (across 150 Ω).
15. Using digital multimeter (level meter) check level at contact X51.B9.
Nominal value: - 7.0 dBm + 1.5 dB
16. Disconnect AF generator from contact X51.B30.

Check of Microphone Current Supply

17. Connect microphone to contacts X51.A30 (ground), X51.B30 (microphone input) and X51.B31 (power supply).
18. Using digital multimeter (voltmeter) check supply voltage at contact X51.B31.
Nominal value: + 4 to + 12 VDC
19. Connect digital multimeter (ammeter) to contact X51.B31 and power supply connection of microphone.

Check of Microphone Transmission

9. Connect AF generator to contact X51.B30.
10. On AF generator set an output voltage of 25 mV (across 150 Ω).
11. Using digital multimeter (level meter) check level at contact X51.B9.
Nominal value: - 7.0 dBm + 1.5 dB
12. On AF generator set an output voltage of 250 mV (across 150 Ω).
20. Using digital multimeter (ammeter) check current consumption.
Nominal value: 11 \pm 2 mA

Check of Carrier Activation

21. Apply low levels (ground) or high levels (open) to contacts X51.B13, .B16, .B25, .A16, .A17 acc. to the table. Using digital multimeter (voltmeter) check voltage at contact X51.B12.

CONTROL UNIT • GB 853C1

Repair Manual • Measurements and Functional Checks

Nominal values:

X51. B25	X51. A17	X51. B13	X51. B16	X51. A16	X51. B12
high	X	X	X	X	+ 4 V ± 1V
low	high	high	high	high	+ 4 V ± 1V
low	low	X	X	X	- 4 V ± 1V
low	X	low	low	X	- 4 V ± 1V
low	X	low	X	low	- 4 V ± 1V

X = arbitrary level

22. Apply a low level (ground) or high level (open) at contacts X51.B13, .B16, .B25, .A16, .A17 acc. to the table. Using digital multimeter (voltmeter) simultaneously check voltage at contact X51.B15.

Nominal values:

X51. B25	X51. A17	X51. B13	X51. B16	X51. A16	X51. B15
high	X	X	X	X	4.95 V = high level
low	high	high	high	high	4.95 V = high level
low	low	X	X	X	0.05 V = low level
low	X	low	low	X	0.05 V = low level
low	X	low	X	low	0.05 V = low level

X = arbitrary level

23. Switch off test equipment.

6.4.3.3 Check of TTY Operation, Line Current

1. Arrange test set-up acc. to Fig. 6.13.
2. Switch on test equipment.

Check of Reception, Single Current

3. Interconnect contacts X51.A5 and X51.A7.
4. Using jumpers X2 to X4 establish the following connections:

X2: 1 - 2, 5 - 6

X3: 1 - 2, 5 - 6

X4: 1 - 2

5. On ± 5-VDC power supply set a voltage of - 5 VDC.
6. Using digital multimeter (amperemeter) check current between contacts X51.A7 and X51.A8.

Nominal value: + 40 ± 4 mA

Check of Reception, Double Current

7. Using jumpers X2 to X4 establish the following connections:

X2: 2 - 3, 4 - 5

X3: 2 - 3, 4 - 5

X4: 1 - 2

8. Using digital multimeter (amperemeter) check current between contacts X51.A7 and X51.A8.

Nominal value: + 20 ± 2 mA

9. On ± 5-VDC power supply set a voltage of + 5 VDC.

CONTROL UNIT • GB 853C1

Repair Manual • Measurements and Functional Checks

10. Using digital multimeter (amperemeter) check current between contacts X51.A7 and X51.A8.
Nominal value: -20 ± 2 mA
 11. Switch off test equipment.
Check of Transmission, Single Current
 12. Interrupt connection between contacts X51.A5 and X51.A7.
 13. Connect digital multimeter (ampere-meter) to contacts X51.A5 and X51.A7.
 14. Switch on test equipment.
 15. Using jumpers X2 to X4 establish the following connections:
X2: 1-2, 5-6
X3: 1-2, 5-6
X4: 1-2
 16. On ± 5 -VDC power supply set a voltage of -5 VDC.
 17. Using digital multimeter (amperemeter) check current.
Nominal value: $+40 \pm 6$ mA
Check of Transmission, Double Current
 18. Using jumpers X2 to X4 establish the following connections:
X2: 2-3, 4-5
X3: 2-3, 4-5
X4: 1-2
 19. Using digital multimeter (amperemeter) check current.
Nominal value: $+20 \pm 4$ mA
 20. On ± 5 -VDC power supply set a voltage of +5 VDC.
 21. Using digital multimeter (amperemeter) check current.
Nominal value: -20 ± 4 mA
Check of Line Current Source
 22. Connect contact X51.A23 to ground (low level).
 23. Using digital multimeter (voltmeter) check voltage at lead-through filters Z4 and Z3.
Nominal value: -30 ± 2 V
Make a note of the measured value.
 24. Using digital multimeter (voltmeter) check voltage at lead-through filters Z2 and Z3.
Nominal value: $+30 \pm 2$ V
Make a note of the measured value.
 25. Calculate unbalance based on the measuring values obtained in steps 23 and 24.
Nominal value: 0 ± 2 V
 26. Switch off test equipment.
- 6.4.3.4 Check of TTY Operation, V.28 Interface**
1. Arrange test set-up acc. to Fig. 6.14.
Check of Reception
 2. Using jumpers X2 to X4 establish the following connections:
X2: 2-3, 4-5
X3: 2-3, 4-5
X4: 1-2
 3. To contact X51.B5 connect AF generator with TTL level converter.

CONTROL UNIT • GB 853C1

Repair Manual • Measurements and Functional Checks

4. Switch on test equipment.
5. On AF generator set a frequency of 25 Hz.
6. Set output voltage of TTL level converter to ± 5 V.
7. Using oscilloscope check rectangular voltage at contact X51.A10.

Nominal value:

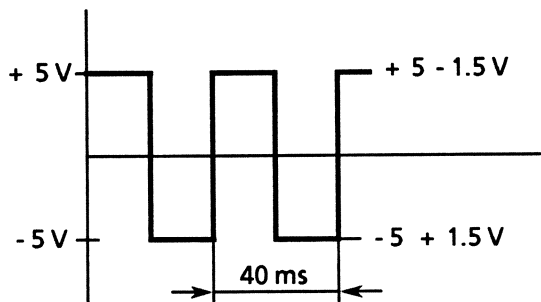

Check of Transmission

8. To contact X51.A9 connect AF generator with TTL level converter.
9. Using jumpers X2 to X4 establish the following connections:
 - X2: 2 - 3, 4 - 5
 - X3: 2 - 3, 4 - 5
 - X4: 2 - 3
10. Using oscilloscope check rectangular voltage at contact X51.B7.

Nominal value:

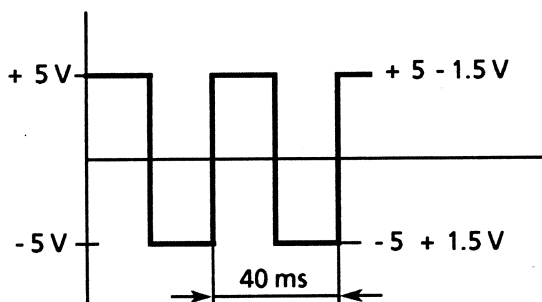

11. Switch off test equipment.

6.4.4 Filter Board

6.4.4.1 Check of T Networks

1. Arrange test set-up acc. to Fig. 6.15.
2. Switch on test equipment.
3. On AF generator set an internal resistance of 600Ω and an output level of 15 dBm.
4. To contact X32.F or X33.F connect AF generator and $50\text{-}\Omega$ resistor with reference to ground.
5. Acc. to the table, on AF generator set the following frequencies in succession and, using AF millivoltmeter, check output level for each of these frequencies at contact X31.B4.

Nominal values:

Frequency	Output Level at X31.B4
100 Hz	2.0 ± 1.5 dBm
1 kHz	2.0 ± 1.5 dBm
10 kHz	2.0 ± 1.5 dBm
20 kHz	2.0 ± 1.5 dBm
70 kHz	-1.0 ± 1.5 dBm
500 kHz	-14.0 ± 6 dBm
1 MHz	≥ -31 dBm

CONTROL UNIT • GB 853C1

Repair Manual • Measurements and Functional Checks

- | | |
|---|---|
| <p>6. To contact X32.H or X33.H connect AF generator and 50-Ω resistor with reference to ground.</p> <p>7. Acc. to the table, on AF generator set the following frequencies in succession and, using AF millivoltmeter, check output level for each of these frequencies at contact X31.A4.</p> | <p>10. To contact X32.C or X33.C connect AF generator and 50-Ω resistor with reference to ground.</p> <p>11. Acc. to the table, on AF generator set the following frequencies in succession and, using AF millivoltmeter, check output level for each of these frequencies at contact X31.A2.</p> |
|---|---|

Nominal values:

Frequency	Output Level at X31.A4
100 Hz	2.0 ± 1.5 dBm
1 kHz	2.0 ± 1.5 dBm
10 kHz	2.0 ± 1.5 dBm
20 kHz	2.0 ± 1.5 dBm
70 kHz	- 1.0 ± 1.5 dBm
500 kHz	- 14.0 ± 6 dBm
1 MHz	≥ - 31 dBm

Nominal values:

Frequency	Output Level at X31.A2
100 Hz	2.0 ± 1.5 dBm
1 kHz	2.0 ± 1.5 dBm
10 kHz	2.0 ± 1.5 dBm
20 kHz	2.0 ± 1.5 dBm
70 kHz	- 1.0 ± 1.5 dBm
500 kHz	- 14.0 ± 6 dBm
1 MHz	≥ - 31 dBm

- | | |
|---|---|
| <p>8. To contact X32.A or X33.A connect AF generator and 50-Ω resistor with reference to ground.</p> <p>9. Acc. to the table, on AF generator set the following frequencies in succession and, using AF millivoltmeter, check output level for each of these frequencies at contact X31.B2.</p> | <p>12. To contact X32.G or X33.G connect AF generator and 50-Ω resistor with reference to ground.</p> <p>13. Acc. to the table, on AF generator set the following frequencies in succession and, using AF millivoltmeter, check output level for each of these frequencies at contact X31.B1.</p> |
|---|---|

Nominal values:

Frequency	Output Level at X31.B2
100 Hz	2.0 ± 1.5 dBm
1 kHz	2.0 ± 1.5 dBm
10 kHz	2.0 ± 1.5 dBm
20 kHz	2.0 ± 1.5 dBm
70 kHz	- 1.0 ± 1.5 dBm
500 kHz	- 14.0 ± 6 dBm
1 MHz	≥ - 31 dBm

Nominal values:

Frequency	Output Level at X31.B1
100 Hz	2.0 ± 1.5 dBm
1 kHz	2.0 ± 1.5 dBm
10 kHz	2.0 ± 1.5 dBm
20 kHz	2.0 ± 1.5 dBm
70 kHz	- 1.0 ± 1.5 dBm
500 kHz	- 14.0 ± 6 dBm
1 MHz	≥ - 31 dBm

CONTROL UNIT • GB 853C1

Repair Manual • Measurements and Functional Checks

14. To contact X32.E or X33.E connect AF generator and 50-Ω resistor with reference to ground.
15. Acc. to the table, on AF generator set the following frequencies in succession and, using AF millivoltmeter, check output level for each of these frequencies at contact X31.A1.

Nominal values:

Frequency	Output Level at X31.A1
100 Hz	2.0 ± 1.5 dBm
1 kHz	2.0 ± 1.5 dBm
10 kHz	2.0 ± 1.5 dBm
20 kHz	2.0 ± 1.5 dBm
70 kHz	-1.0 ± 1.5 dBm
500 kHz	-14.0 ± 6 dBm
1 MHz	≥ -31 dBm

16. Switch off test equipment.

6.4.4.2 Check of II Networks

1. Arrange test set-up acc. to Fig. 6.15.
2. Switch on test equipment.
3. On AF generator set an internal resistance of 600 Ω and an output level of 15 dBm.
4. To contact X32.J or X33.J connect AF generator and 50-Ω resistor with reference to ground.
5. Acc. to the table, on AF generator set the following frequencies in succession and, using AF millivoltmeter, check output level for each of these frequencies at contact X31.A3.

Nominal values:

Frequency	Output Level at X31.A3
100 Hz	4.0 ± 1.0 dBm
1 kHz	4.0 ± 1.0 dBm
10 kHz	4.0 ± 2.0 dBm
30 kHz	4.0 ± 2.0 dBm
50 kHz	4.0 ± 2.0 dBm
70 kHz	4.0 ± 2.0 dBm
100 kHz	2.0 ± 2.0 dBm
500 kHz	-3 ± 3.0 dBm
1 MHz	≥ -12 dBm

6. To contact X32.B or X33.B connect AF generator and 50-Ω resistor with reference to ground.
7. Acc. to the table, on AF generator set the following frequencies in succession and, using AF millivoltmeter, check output level for each of these frequencies at contact X31.B3.

Nominal values:

Frequency	Output Level at X31.B3
100 Hz	4.0 ± 1.0 dBm
1 kHz	4.0 ± 1.0 dBm
10 kHz	4.0 ± 2.0 dBm
30 kHz	4.0 ± 2.0 dBm
50 kHz	4.0 ± 2.0 dBm
70 kHz	4.0 ± 2.0 dBm
100 kHz	2.0 ± 2.0 dBm
500 kHz	-3 ± 3.0 dBm
1 MHz	≥ -12 dBm

8. Switch off test equipment.

CONTROL UNIT • GB 853C1

Repair Manual • Measurements and Functional Checks

6.4.5 Keyboard PCB

1. Arrange test set-up acc. to Fig. 6.16.
2. Switch on digital multimeter (ohmmeter).
3. Acc. to the table below, connect the following contacts in succession to the digital multimeter (ohmmeter), press respective key and check short-circuit resistance.

Ohmmeter Connection X11. and X11.		Key
X11.2	X11.1	0
	X11.3	2
	X11.5	5
	X11.7	RCL
	X11.12	+
	X11.16	8
X11.4	X11.1	.
	X11.3	1
	X11.5	4
	X11.7	TEST
	X11.12	VC
	X11.16	7
X11.6	X11.1	ENT
	X11.3	3
	X11.5	6
	X11.7	STO
	X11.12	-
	X11.16	9
X11.10	X11.1	FRQ
	X11.3	LINE
	X11.5	BFO
	X11.7	TUNE
	X11.12	EXT
	X11.14	NB
X11.16	CH	

Nominal values: 0Ω

4. Connect the contacts given in the table above (step 3) in succession to the digital multimeter (ohmmeter) and check no-load resistance

Nominal values: $> 10 M\Omega$

5. Switch off digital multimeter (ohmmeter).

6.4.6 Display Board

6.4.6.1 Check of Switches S2, S3 and S4

1. Arrange test set-up acc. to Fig. 6.17
2. Switch on digital multimeter (ohmmeter).
3. Acc. to the table below, connect the following contacts in succession to the digital multimeter (ohmmeter), switch control mode switch S2 to the given position and check short-circuit resistance.

Ohmmeter Connection	Switch Position (S2)
X21.B32 and X21.A17	Rx
X21.B32 and X21.B17	Rx / Tx
X21.B32 and X21.A18	CH
X21.B32 and X21.B18	MAN

Nominal values: 0Ω

4. Using digital multimeter check contacts X21.A17, X21.B17, X21.A18 and X21.B18 one after the other for short-circuits among these contacts.

Nominal values: $> 10 M\Omega$

5. Acc. to the table below, connect the following contacts in succession to the digital multimeter (ohmmeter), switch FSK switch S3 to the given position and check short-circuit resistance.

Ohmmeter Connection	Switch Position (S3)
X21.B32 and X21.A15	Rx
X21.B32 and X21.B16	STBY
X21.B32 and X21.B15	Tx

CONTROL UNIT • GB 853C1

Repair Manual • Measurements and Functional Checks

6. Using digital multimeter check contacts X21.A15, X21.B16 and X21.B15 one after the other for short-circuits among these contacts.

Nominal values: $> 10\text{ M}\Omega$

7. Acc. to the table below, connect the following contacts in succession to the digital multimeter (ohmmeter), set OPERATION MODE switch S4 to the given position and check short-circuit resistance.

Ohmmeter Connection	Switch Position (S4)
X21.B32 and X21.A19	OFF
X21.B32 and X21.B19	Rx
X21.B32 and X21.A20	Tx1
X21.B32 and X21.B20	Tx2
X21.B32 and X21.A21	Tx3
X21.B10 and X21.B9	Rx
X21.B10 and X21.B9	Tx1
X21.B10 and X21.B9	Tx2
X21.B10 and X21.B9	Tx3

Nominal values: $0\ \Omega$

8. Using digital multimeter check contacts X21.A19, X21.B19, X21.A20, X21.B20 and X21.A21 one after the other for short-circuits among these contacts.

Nominal values: $> 10\text{ M}\Omega$

9. Set OPERATION MODE switch S4 to position "OFF" and check resistance between contacts X21.B10 and X21.B9.

Nominal value: $> 10\text{ M}\Omega$

10. Switch off digital multimeter (ohmmeter).

6.4.6.2 Check of LED "SQUELCH"

1. Arrange test set-up acc. to Fig. 6.17.
2. Connect contact X21.B7 to ground.
3. Switch on + 5.3-VDC power supply.
4. Check LED "SQUELCH".

Nominal value: LED illuminated

5. Disconnect contact X21.B7 from ground.
6. Check LED "SQUELCH".

Nominal value: LED is extinguished

7. Switch off + 5.3-VDC power supply.

6.4.6.3 Check of Clock Generator

1. Arrange test set-up acc. to Fig. 6.17.
2. Connect oscilloscope to integrated circuit D2, contact 10.
3. Switch on test equipment.
4. Using oscilloscope check rectangular voltage.

Nominal value:

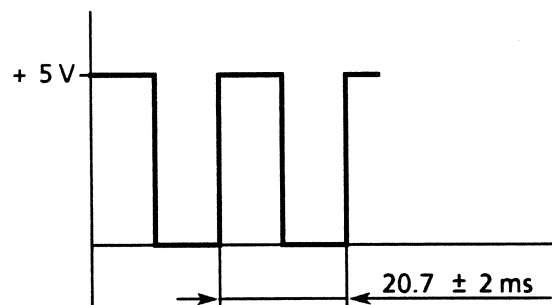

5. Switch off test equipment.

CONTROL UNIT • GB 853C1

Repair Manual • Measurements and Functional Checks

6.4.6.4 Check of Illumination Unit

1. Arrange test set-up acc. to Fig. 6.17.
2. Switch on + 5.3-VDC power supply.
3. Check LEDs of illumination unit.
Nominal value: LEDs illuminated
4. Switch off + 5.3-VDC power supply.

5. Switch off power supply units and separate them from connector X61.

6.4.7.2 Check for Continuity

1. Arrange test set-up acc. to Fig. 6.18.
2. Using digital multimeter (ohmmeter) check tracks at the contacts of the motherboard one after the other for continuity acc. to the circuit diagram.

Nominal values: 0 Ω

6.4.7 Motherboard

(See circuit diagram 649.4011.015.)

6.4.7.1 Check of Supply Voltages

1. Arrange test set-up acc. to Fig. 6.18.
2. Connect power supply to the contacts of connector X61 given in the test set-up.
3. Switch on power supply units.
4. Using digital multimeter (voltmeter) check supply voltages one after the other at the following contacts.

Nominal values:

X51.B2:	+ 16 VDC
X51.A3:	- 16 VDC
X51.B1:	- 5 VDC
X41.A30:	+ 16 VDC
X41.B29:	- 16 VDC
X41.A31:	- 5 VDC
X41.B30:	+ 7.25 VDC
X21.A10:	- 5 VDC

6.4.7.3 Check for Short-circuit

1. Arrange test set-up acc. to Fig. 6.18.
2. Using digital multimeter (ohmmeter) check the tracks at the contacts of the motherboard one after the other for short-circuits with reference to ground acc. to the circuit diagram.
3. Using digital multimeter (ohmmeter) check the tracks at the contacts of the motherboard one after the other for short-circuits among these contacts.

Nominal values: > 10 M Ω

Nominal values: > 10 M Ω

Note:

According to the circuit diagram, some of the tracks are interconnected for functional reasons. When measurements are performed at these contacts, the respective nominal value is 0 Ω .

CONTROL UNIT • GB 853C1

Repair Manual • Replacement of Assemblies and Components

6.5 Replacement of Assemblies and Components

6.5.1 Preparations

Prior to the replacement of assemblies and components remove the Control Unit GB 853C1 from Case KK 853C1 or Case with Power Supply KK 853C2 and disassemble the control unit. For this purpose proceed as follows:

Removal from Case KK 853C1

1. Switch off the radio set connected to Case KK 853C1 and also switch off teletyper if connected.
2. Undo the nut of the ground connection and disconnect the ground line from the case.
3. Separate connectors X71 (REMOTE) to the radio set and X72 (AF / TTY) to the teletyper on the rear of the case.
4. Undo four Phillips screws on the rear of the case.
5. Pull the Control Unit GB 853C1 out of the case towards the front.
6. Disconnect the ribbon cable from male connector strip X61.
7. Undo four Phillips screws on the aluminium cover of the control unit.
8. Remove the aluminium cover.
9. Carefully pull the respective module out of the motherboard towards the top.

Installation is in the reverse order to the removal described above.

Removal from Case with Power Supply KK 853C2

1. Switch off the power supply module of Case with Power Supply KK 853C2.
2. Switch off the radio set connected to the case with power supply and the teletyper if connected.
3. Disconnect the mains connection cable and / or the battery connection cable on the rear of the case with power supply.
4. Undo the nut of the ground connection and disconnect the ground line from the case.
5. Separate connectors X71 (REMOTE) to the radio set and X72 (AF / TTY) to the teletyper on the rear of the case.
6. Undo four captive screws on Control Unit GB 853C1.
7. Pull the Control Unit GB 853C1 out of the case towards the front.
8. Undo the internal connections between the control unit and the case with power supply.
9. Undo four Phillips screws on the aluminium cover of the control unit.
10. Remove the aluminium cover.
11. Carefully pull the respective module out of the motherboard towards the top.

Installation is in the reverse order to the removal described above.

CONTROL UNIT • GB 853C1

Repair Manual • Replacement of Assemblies and Components

6.5.2 Replacement of Individual Components

The replacement of components on the printed circuit boards follows usual workshop practice. No special instructions are necessary.

Among the components incorporated in the control unit there are electrostatic sensitive devices (ESD) and surface-mounted devices.

Therefore the following requirements should be observed:

CAUTION

For the replacement of electrostatic sensitive devices (ESD), MOS, MOSFET and CMOS devices a special CMOS work station is required.

Make sure the supply voltages are switched off before opening the unit or carrying out any soldering on any component.

Note:

- *During soldering work on circuit boards it is possible for the metal foil to come away from the base material if too much heat is applied. Consequently, soldering should be accomplished as speedily as possible.*
- *Parts, wire insulation or printed circuit boards that are charred, melted or burnt must be replaced.*
- *Parts on which heat has caused the material to discolour should be thoroughly examined to determine whether their major characteristics have been seriously affected. If so, these parts must be replaced.*
- *Circuit boards on which mechanical damage or line breaks are found should be replaced.*

CONTROL UNIT • GB 853C1

Repair Manual • Final Test

6.6 Final Test

After a repair has been carried out, the Control Unit GB 853C1 must be subjected to the following final test to ensure that its technical data can still be guaranteed.

If this final test proves satisfactory, the repair is completed.

If this is not the case, the testing and troubleshooting will have to be performed again. Repeat the procedure as many times as is necessary to detect and eliminate all faults.

6.6.1 Test of AF Reception

6.6.1.1 Test of Loudspeaker Amplifier

1. Arrange test set-up acc. to Fig. 6.19.
2. Connect AF generator to contact X61.B12.
3. Connect loudspeaker to contact X33.J.
4. Switch on test equipment.
5. On AF generator set a frequency of 1 kHz, an internal resistance of 600 Ω and an output level of -6 dBm.
6. Turn SQUELCH potentiometer fully counter-clockwise.
7. Turn VOLUME potentiometer fully clockwise.
8. Check LED "SQUELCH".
Nominal value: LED illuminated
9. Using digital multimeter (level meter) check level at contact X33.J.
Nominal value: ≥ 30 dBm
10. Set switch "Loudspeaker on / off" to position "ON".
11. Check tone of built-in loudspeaker.
Nominal value: 1-kHz tone
12. Set switch "Loudspeaker on / off" to position "OFF".
13. Turn SQUELCH potentiometer fully clockwise.
14. Check LED "SQUELCH".
Nominal value: LED goes out after approx. 1.5 s
15. Using digital multimeter (level meter) check levels at contacts X33.J, X32.J and X61.B13 one after the other.
Nominal value: 17 ± 3 dB
16. Connect contact X61.A18 to ground (low level).
17. Using digital multimeter (voltmeter) check voltage at contact X61.B20.
Nominal value: 0.05 V (low level)
18. Disconnect contact X61.A18 from ground and connect contact X33.F to ground (low level).
19. Using digital multimeter (voltmeter) check voltage at contact X61.B20.
Nominal value: 0.05 V (low level)
20. Disconnect contact X33.F from ground and connect contact X32.F to ground (low level).
21. Using digital multimeter (voltmeter) check voltage at contact X61.B20.
Nominal value: 0.05 V (low level)

CONTROL UNIT • GB 853C1

Repair Manual • Final Test

22. Disconnect contact X32.F from ground.
23. Connect contact X61.A18 to ground (low level).
24. Using digital multimeter (level meter) check level at contact X61.B13.
Nominal value: > 20 dB
25. Switch off test equipment.
2. Connect AF generator to contact X61.B12.
3. Switch on test equipment.
4. On AF generator set a frequency of 1 kHz, an internal resistance of 600Ω and an output level of - 6 dBm.
5. Using digital multimeter (level meter) check level at contact X61.A13.
Nominal value: $0.0 \text{ dBm} + 0.35 / - 0.2 \text{ dB}$

6. Switch off test equipment.

6.6.1.2 Test of Headphones Amplifier

1. Arrange test set-up acc. to Fig. 6.19.
2. Connect AF generator to contact X61.B12.
3. Switch on test equipment.
4. On AF generator set a frequency of 1 kHz, an internal resistance of 600Ω and an output level of - 6 dBm.
5. Turn squelch potentiometer fully counter-clockwise.
6. Using digital multimeter (level meter) check level at contact X33.A.
Nominal value: ≥ 17 dBm
7. Turn squelch potentiometer fully clockwise.
8. Using digital multimeter (level meter) check level at contact X32.A.
Nominal value: 17 ± 3 dB
9. Switch off test equipment.

6.6.1.3 Test of AF Reception

1. Arrange test set-up acc. to Fig. 6.19.

6.6.2 Test of AF Transmission

6.6.2.1 Test of AF Modulation

1. Arrange test set-up acc. to Fig. 6.19.
2. Connect AF generator to contact X61.A15.
3. Switch on test equipment.
4. On AF generator set a frequency of 1 kHz, an internal resistance of 600Ω and an output level of 0 dBm.
5. Using digital multimeter (level meter) check level at contact X61.A15.
Nominal value: $0.0 \text{ dBm} + 0.25 / - 0.2 \text{ dB}$
6. Using digital multimeter (level meter) check level at contact X61.B10.
Nominal value: $- 6.0 \text{ dBm} + 1.0 \text{ dB}$
7. Switch off test equipment.

6.6.2.2 Test of Microphone Transmission

1. Arrange test set-up acc. to Fig. 6.19.

CONTROL UNIT • GB 853C1

Repair Manual • Final Test

2. Connect AF generator to contact X33.C.
3. Switch on test equipment.
4. On AF generator set an internal resistance of $5\ \Omega$ and an output voltage of 25 mV (across $150\ \Omega$).
5. Press key FSK7 or FSK8.
6. Using digital multimeter (level meter) check level at contact X61.B10.
Nominal value: $-7.0\ \text{dBm} + 1.5\ \text{dB}$
7. On AF generator set an output voltage of 775 mV (across $150\ \Omega$).
8. Using digital multimeter (level meter) check level at contact X61.B10.
Nominal value: $-7.0\ \text{dBm} + 1.5\ \text{dB}$
9. Disconnect AF generator from contact X33.C.
10. Connect AF generator to contact X32.C.
11. On AF generator set an internal resistance of $5\ \Omega$ and an output voltage of 250 mV (across $150\ \Omega$).
12. Using digital multimeter (level meter) check level at contact X61.B10.
Nominal value: $-7.0\ \text{dBm} + 1.5\ \text{dB}$
13. Disconnect AF generator from contact X32.C.
14. Connect microphone to contacts X33.G (ground) and X33.E (power supply).
15. Using digital multimeter (voltmeter) check supply voltage at contact X33.E.
Nominal value: $+5 \pm 0.3\ \text{VDC}$
16. Connect digital multimeter (ammeter) between contact X33.E and power supply connection of microphone.
17. Using digital multimeter check current.
Nominal value: $12 \pm 3\ \text{mA}$
18. Connect microphone to contacts X32.G (ground) and X32.E (power supply).
19. Using digital multimeter (voltmeter) check supply voltage at contact X32.E.
Nominal value: $+5 \pm 0.3\ \text{VDC}$
20. Connect digital multimeter (ammeter) between contact X32.E and power supply connection of microphone.
21. Using digital multimeter check current.
Nominal value: $12 \pm 3\ \text{mA}$
22. Switch off test equipment.

6.6.3 Test of Squelch

1. Arrange test set-up acc. to Fig. 6.19.
2. Connect AF generator to contact X61.B12.
3. Connect sweep generator to AF generator input "SWEEP".
4. Switch on test equipment.
5. On AF generator set a frequency of 1 kHz, an internal resistance of $600\ \Omega$ and an output level of $-6\ \text{dBm}$.
6. On sweep generator set a sweep frequency of 2 Hz, an internal resistance of $5\ \Omega$ and an output voltage of 1 mV.

CONTROL UNIT • GB 853 C 1

Repair Manual • Final Test

7. Turn squelch potentiometer fully counter-clockwise.
Nominal value: LED illuminated
 8. Using digital multimeter (voltmeter) check voltage at contact X61.A19.
Nominal value: 0.05 V (low level)
 9. Using digital multimeter (voltmeter) check voltage at contact X33.H.
Nominal value: 0.05 V (low level)
 10. Using digital multimeter (voltmeter) check voltage at contact X32.H.
Nominal value: 0.05 V (low level)
 11. On the front panel check LED "SQUELCH".
Nominal value: LED illuminated
 12. Turn squelch potentiometer fully clockwise.
 13. Using digital multimeter (voltmeter) check voltage at contact X61.A19.
Nominal value: 4.95 V (high level)
 14. Using digital multimeter (voltmeter) check voltage at contact X33.H.
Nominal value: 4.95 V (high level)
 15. Using digital multimeter (voltmeter) check voltage at contact X32.H.
Nominal value: 4.95 V (high level)
 16. On the front panel check LED "SQUELCH".
Nominal value: LED is extinguished
 17. Turn squelch potentiometer to medium position until squelch opens.
 18. From medium position turn potentiometer clockwise by approx. one graduation line until the squelch closes.
Nominal value: LED is extinguished
- Note:**
Turn potentiometer slowly, as the squelch closes with a delay of approx. 1.5 s.
19. Switch off test equipment.
- ### 6.6.4 Test of TTY Operation, Line Current
- #### 6.6.4.1 Test of Reception
1. Arrange test set-up acc. to Fig. 6.20.
 2. Connect ± 5 -VDC power supply to contact X61.B6.
 3. Switch off test equipment.
 4. On ± 5 -VDC power supply set a voltage of -5 VDC.
 5. Set control mode switch S2 to position "MAN", FSK switch S3 to position "Rx" and OPERATION MODE switch S4 to position "Tx / Rx 1".
 6. On the audio board establish the following connections using jumpers X2 to X4 (single current):
X2: 1 - 2, 5 - 6
X3: 1 - 2, 5 - 6
X4: 1 - 2
 7. Using digital multimeter (ammeter) check current (single current) between contacts X61.A8 and X61.A9.
Nominal value: $+ 40 \pm 4$ mA

CONTROL UNIT • GB 853C1

Repair Manual • Final Test

8. On the audio board establish the following connections using jumpers X2 to X4 (double current):
X2: 2-3, 4-5
X3: 2-3, 4-5
X4: 1-2
 9. Using digital multimeter (amperemeter) check current (double current) between contacts X61.A8 and X61.A9.
Nominal value: $+ 20 \pm 2$ mA
 10. On ± 5 -VDC power supply set a voltage of + 5 VDC.
 11. Using digital multimeter (amperemeter) check current (double current) between contacts X61.A8 and X61.A9.
Nominal value: $- 20 \pm 2$ mA
 12. Switch off test equipment.
7. Using digital multimeter (amperemeter) check current (single current) between contacts X61.A8 and X61.A6.
Nominal value: $+ 40 \pm 6$ mA
 8. On the audio board establish the following connections using jumpers X2 to X4 (double current):
X2: 2-3, 4-5
X3: 2-3, 4-5
X4: 1-2
 9. Using digital multimeter (amperemeter) check current (double current) between contacts X61.A8 and X61.A6.
Nominal value: $+ 20 \pm 4$ mA
 10. On ± 5 -VDC power supply set a voltage of + 5 VDC.
 11. Using digital multimeter (amperemeter) check current (double current) between contacts X61.A8 and X61.A6.
Nominal value: $- 20 \pm 4$ mA
 12. Switch off test equipment.

6.6.4.2 Test of Transmission

1. Arrange test set-up acc. to Fig. 6.20.
2. Connect ± 5 -VDC power supply to contact X61.B6.
3. Switch on test equipment.
4. On ± 5 -VDC power supply set a voltage of - 5 VDC.
5. Set control mode switch S2 to position "MAN", FSK switch S3 to position "Rx" and OPERATION MODE switch S4 to position "Tx/Rx 1".
6. On the audio board establish the following connections using jumpers X2 to X4 (single current):
X2: 1-2, 5-6
X3: 1-2, 5-6
X4: 1-2

6.6.5 Test of TTY Operation, V.28-Interface

6.6.5.1 Test of Reception

1. Arrange test set-up acc. to Fig. 6.20.
2. On the audio board establish the following connections using jumpers X2 to X4:
X2: 2-3, 4-5
X3: 2-3, 4-5
X4: 1-2
3. Connect contact X61.A6 to X61.A8 and X61.A7 to X61.A9.

CONTROL UNIT • GB 853C1

Repair Manual • Final Test, External Interfaces

4. Set control mode switch S2 to position "MAN", FSK switch S3 to position "Rx" and OPERATION MODE switch S4 to position "Tx/Rx 1".
5. Connect AF generator with TTL level converter to contact X61.B6.
6. Switch on test equipment.
7. On AF generator set a frequency of 25 Hz.
8. Set output voltage of TTL level converter to ± 5 V.
9. Using oscilloscope check rectangular voltage at contact X61.A11.

Nominal value:

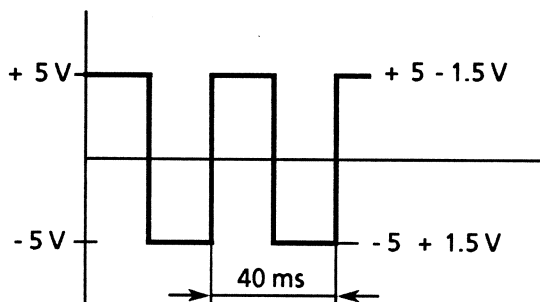

10. Switch off test equipment.

6.6.5.2 Test of Transmission

1. Arrange test set-up acc. to Fig. 6.20.
2. On the audio board establish the following connections using jumpers X2 to X4:

X2: 2 - 3, 4 - 5
 X3: 2 - 3, 4 - 5
 X4: 2 - 3

3. Connect contact X61.A6 to X61.A8 and X61.A7 to X61.A9.

4. Set control mode switch S2 to position "MAN", FSK switch S3 to position "Rx" and OPERATION MODE switch S4 to position "Tx/Rx 1".
5. Connect AF generator with TTL level converter to contact X61.A10.
6. Switch on test equipment.
7. On AF generator set a frequency of 25 Hz.
8. Set output voltage of TTL level converter to ± 5 V.
9. Using oscilloscope check rectangular voltage at contact X61.B8.

Nominal value:

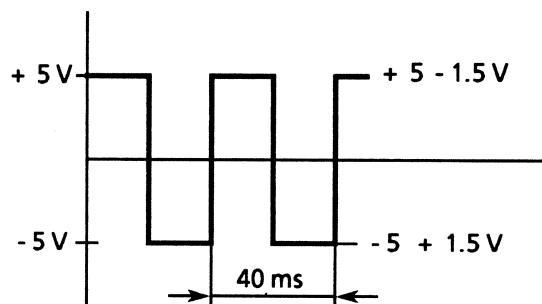

10. Switch off test equipment.

6.7 External Interfaces

A detailed description of the external interfaces of the Control Unit GB 853C1 is provided in the appendix of this manual.



ROHDE & SCHWARZ

Communications Division

Appendix

INTERFACE DESCRIPTION

CIRCUIT DIAGRAMS

PARTS LISTS

COMPONENTS LAYOUTS

CONTROL UNIT • GB 853C1

Repair Manual • Interface Description

A.1 Interface Description

Contact	Signal Name Description	Direction	Type	Range of Value	Remarks
X32.A	Headphones	output	analog	50 mW into 600 Ω , adjustable via loudspeaker pot., reference ground X32.B	unbalanced
X32.B	Loudspeaker (\perp)	output	analog	0 V	
X32.C	Microphone input	input	analog	250 mV \pm 10 mV into $R_I = 150 \Omega \pm 5\%$ reference point X32.E	
X32.D	not used				
X32.E	Microphone + 6 V	input	analog	$V_{out} 5.3 V - 0.5 V$ $I_{out} < 15 mA$	supply for microphone amplifier
X32.F	Transmit (inv.)	input	low	CMOS input	pull up 1 k Ω
X32.G	Microphone ground	input	analog	0 V	ground for microphone
X32.H	Squelch (inv.)	output	low	$V \leq 30 V, I \leq 50 mA,$ $R_I = 100 \Omega \pm 5\%$	open collector, low when AF signal is present
X32.J	Loudspeaker	output	analog	$P \leq 1 W$ into 4 $\Omega \pm 5\%$	adjustable via loudspeaker potentiometer
X33.A	Headphones	output	analog	50 mW into 600 Ω , adjustable via loudspeaker potentiometer, reference ground X32.B	unbalanced
X33.B	Loudspeaker (\perp)	output	analog	0 V	
X33.C	Microphone input	input	analog	250 mV \pm 10 mV into $R_I = 150 \Omega \pm 5\%$ reference point X32.E	
X33.D	not used				
X33.E	Microphone + 6 V	input	analog	$V_{out} 5.3 V - 0.5 V$ $I_{out} < 15 mA$	supply for microphone amplifier
X33.F	Transmit (inv.)	input	low	CMOS input	pull-up 1 k Ω

CONTROL UNIT • GB 853C1

Repair Manual • Interface Description

Contact	Signal Name Description	Direction	Type	Range of Value	Remarks
X33.G	Microphone ground	input	analog	0 V	ground for microphone
X33.H	Squelch (inv.)	output	low	$V \leq 30 \text{ V}$, $I \leq 50 \text{ mA}$, $R_I = 100 \Omega \pm 5 \%$	open collector, low when AF signal is present
X33.J	Loudspeaker	output	analog	$P \leq 1 \text{ W}$ into $4 \Omega \pm 5 \%$	adjustable via loudspeaker potentiometer
X61.a1	0 V				ground
X61.a2	+ 16 V	input		+ 16 V \pm 0.5 V, $I \leq 500 \text{ mA}$	AF amplifier nominal power
X61.a3	+ 7.25 V	input		+ 7.25 V \pm 0.25 V $I \leq 800 \text{ mA}$	line current switched on
X61.a4	+ 5.3 V	input		+ 5.3 V \pm 0.1 V $I \leq 800 \text{ mA}$	line current switched on
X61.a5	-16 V	input		-16 V \pm 1 V $I \leq 30 \text{ mA}$	
X61.a6	TTY transmit a	input		$V_{in} = 60 \text{ V}$ or $\pm 30 \text{ V}$ referred to X61.a7, $I_{in} = 40 \text{ mA}$ or $\pm 20 \text{ mA}$	line current drain
X61.a7	TTY transmit b	input		reference point for X61.a6	line current
X61.a8	TTY receive a	output		$V_{out} = 60 \text{ V}$ or $\pm 30 \text{ V}$ referred to X61.a9, $I_{out} = 40 \text{ mA}$ or $\pm 20 \text{ mA}$	line current current source
X61.a9	TTY receive b	output		reference point for X61.a8	line current
X61.a10	TTY transmit V.28	input		V.10 input	unbalanced
X61.a11	TTY receive V.28	output		V.10 output	unbalanced
X61.a12	TTY \perp ground			V.10 reference ground	
X61.a13	AF receive a	output		1 dBm + 0.5 dBm $R_I = 600 \Omega \pm 5 \%$ frequency response < 1 dB 300 Hz to 3.4 kHz	unbalanced

CONTROL UNIT • GB 853C1

Repair Manual • Interface Description

Contact	Name	Signal Description	Direction	Type	Range of Value	Remarks
X61.a14	AF receive b		output		reference ground for X.61.a13	
X61.a15	AF transmit a		input		-1 dBm + 0.5 dBm $R_I = 600 \Omega \pm 5 \%$ frequency response < 1 dB 300 Hz to 3.4 kHz	unbalanced
X61.a16	AF transmit b		input		reference ground for X.61.a15	
X61.a17	F1 transmit (inv.)		input	low	CMOS input	pull-up 10 k Ω
X61.a18	Transmit (inv.)		input	low	CMOS input	pull-up 10 k Ω
X61.a19	Squelch (inv.)		output	low	$V \leq 30 \text{ V}$, $I \leq 50 \text{ mA}$, $R_I = 100 \Omega \pm 5 \%$	open collector, serial resistor 100 Ω
X61.a20	Test trigger ext. (inv.)		input	low	CMOS input	pull-up 56 k Ω
X61.a21	S2		output	high	V.10 output	switch on trans- mission, V.24 interface
X61.a22	D1 (inv.)		output		V.10 output	data output inverted
X61.a23	D2 (inv.)		input		V.10 input	data output inverted
X61.a24	S1.2		output	high	V.10 output	V.24 interface ready for operation
X61.a25	E2 (\perp)				V.10 ground	reference ground for V.24 interface
X61.b1	0 V					ground
X61.b2	+ 16 V		input		see X61.a2	
X61.b3	+ 7.25 V		input		see X61.a3	
X61.b4	+ 5.3 V		input		see X61.a4	
X61.b5	-5 V		input		-5.3 V \pm 0.3 V $I \leq 50 \text{ mA}$	

CONTROL UNIT • GB 853C1

Repair Manual • Interface Description

Contact	Signal Name Description	Direction	Type	Range of Value	Remarks
X61.b6	TTY demod local	input		V.10 input	unbalanced
X61.b7	0 V			ground	reference ground for X61.b6
X61.b8	TTY mod. local	output		V.10 output	unbalanced
X61.b9	⊥ ground			reference ground for X61.b10	reference ground for X61.b8
X61.b10	AF mod. local	output		-7 dBm + 0.5 dBm $R_i = 600 \Omega \pm 5 \%$ frequency response < 1 dB 300 Hz to 3.4 kHz	unbalanced
X61.b11	⊥ ground			reference ground for X61.b12	
X61.b12	AF demod. local	input		-5 dBm + 0.5 dBm $R_i = 600 \Omega \pm 5 \%$ frequency response < 1 dB 300 Hz to 3.4 kHz	unbalanced
X61.b13	Loudspeaker	output		$P \leq 1 \text{ W into } R = 4 \Omega$	output power depending on position of potentiometer volume
X61.b14	Loudspeaker ⊥	output		0 V	
X61.b15	On a	input		$V < 40 \text{ V}$	switching contact
X61.b16	On b	input		$V < 40 \text{ V}$	switching contact
X61.b17	Local code (inv.)	input	low	CMOS input	pull-up 100 k Ω
X61.b18	Reset (inv.)	input	low	CMOS input	pull-up 560 k Ω
X61.b19	OFF (inv.)	output	low	contact to 0 V	
X61.b20	LOC. Carrier activ (inv.)	output	low	V.10 output	unbalanced

CONTROL UNIT • GB 853C1

Repair Manual • Interface Description

Contact	Name	Signal Description	Direction	Type	Range of Value	Remarks
X61.b21	I D 1		output			data output V.24 interface
X61.b22	T				V.10 input	
X61.b23	I D 2		input		V.10 input	data output V.24 interface
X61.b24	M 1		input	high	V.10 input	V.24 interface ready for operation, unbalanced
X61.b25	M 2		input	high	V.10 input	V.24 interface ready for operation, unbalanced

CONTROL UNIT • GB 853C1

Repair Manual • Interface Description

$V_{dd} = +5.3\text{ V}$

Parameter	Symbol	Value	Condition
Output voltage low	V_{ol}	0.05 V	$I_o \leq 1\ \mu\text{A}$
Output voltage high	V_{oh}	4.95 V	$I_o \leq 1\ \mu\text{A}$
Input voltage low	V_{il}	1.5 V	$I_o \leq 1\ \mu\text{A}$
Input voltage high	V_{ih}	3.5 V	$I_o \leq 1\ \mu\text{A}$
Output current low	I_{ol}	0.36 mA	$V_o = 0.4\text{ V}$
Output current high	$-I_{oh}$	0.36 mA	$V_o = 4.6\text{ V}$

Fig. 1 (Values see table above)

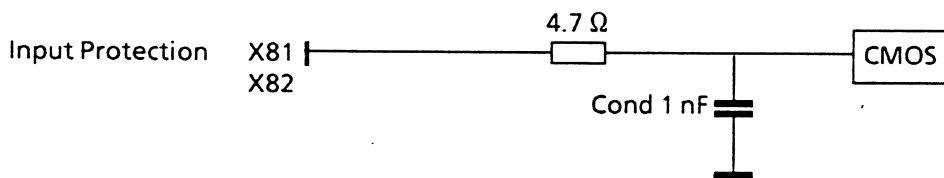
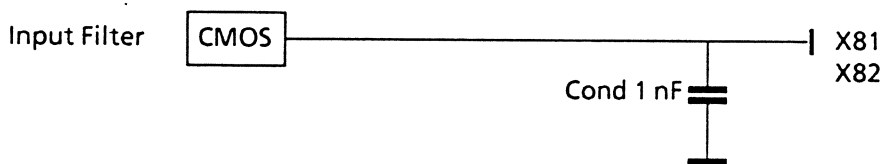

Fig. 2 (Values see table above)



Kennz. Comp.No.	Benennung Designation	Sachnummer Stock No.	Hersteller Manufacturer	Bezeichnung Designation	enthalten in contained in	
	VARIANTENERKL. / VERSIONS VAR 02 = RAL 7035/LCD/LED MOD 02 = RAL 7035/LCD/LED VAR 03 = RAL 6014/LCD/LED MOD 03 = RAL 6014/LCD/LED VAR 04 = RAL 7001/LCD/LED MOD 04 = RAL 7001/LCD/LED VAR 11 = RAL 6031/LCD MOD 11 = RAL 6031/LCD VAR 12 = RAL 7035/LCD MOD 12 = RAL 7035/LCD VAR 13 = RAL 6014/LCD MOD 13 = RAL 6014/LCD VAR 14 = RAL 7001/LCD MOD 14 = RAL 7001/LCD VAR 15 = RAL 7035/LCD MOD 15 = RAL 7035/LCD GB853C1 FUNKTIONIERT OHNE RUECKMELDUNG FUNKTIONS WITHOUT ACKNOWLEDGEMENT VAR 17 = RAL 7001/LCD/ MOD 17 = RAL 7001/LCD/ FUER XK852C3 U. GX859C3 FOR XK852C3 AND GX859C3 VAR 18 = RAL 7035/LCD/ MOD 18 = RAL 7035/LCD/ FUER GX859C3 FOR GX859C3 SOFTWARE VAR/MODELS VAR 02 = GRUNDAUSFUEHRUNG FUER GERAETE-VAR. 11, 12, 13, 14, 15 MOD 02 = BASIC VERSION FOR EQUIPMENT MODEL 11, 12, 13, 14, 15 VAR 03 = MARINEAUSFUEHRUNG FUER GERAETEVAR. 17, 18 MOD 03 = NAVY VERSION FOR EQUIPMENT MODEL 17, 18 .. ZUEGH.STROML./CIRC.DIAGR. 0649.4011 S					
A1	ED TASTENPLATTE KEYBOARD PCB	649.4111.02			649.4070.01	
A2	ED ANZEIGEPLATTE INDICATION BOARD	649.4134.02			649.4070.01	
A2	NUR VAR/ONLY MOD: 02 03 04 ED ANZEIGEPLATTE DISPLAY PANEL NUR VAR/ONLY MOD: 11 12 13 14 17 18	649.5676.02			649.4070.01	
A3	ED FILTERPLATTE FILTER	649.4157.02			649.4070.01	
A4	EE PROZESSORPLATTE PROCESSOR	649.4170.02				
A5	EE AUDIOPLATTE AUDIO BOARD NUR VAR/ONLY MOD: 02 03 04 11 12 13 14 15	649.4192.02				
A5	EE AUDIOPLATTE NUR VAR/ONLY MOD: 17 18	649.4192.03				
A6	ED MOTHERBOARD MOTHERBOARD	649.4211.02				
A41	HS SOFTWARE I SOFTWARE I NUR VAR/ONLY MOD: 02 03 04	649.5501.02				
A41	HS SOFTWARE II SOFTWARE II NUR VAR/ONLY MOD: 11 12 13 14 15	649.5530.02				
A41	HS SOFTWARE IV NUR VAR/ONLY MOD: 17 18	649.5853.03				
ROHDE & SCHWARZ		Äl	Schaltteilliste für Parts list for		Sachnummer Stock No.	Blatt Page
		Date				
		14 1092	GB853C1 BEDIENGERAET GB853C1 CONTROL UNIT		649.4011.01 SA	1+

Kennz. Comp.No.	Benennung Designation	Sachnummer Stock No.	Hersteller Manufacturer	Bezeichnung Designation	enthalten in contained in
B1	EL KLEINLAUTSPR. 0,5W250HM LOUDSPEAKER	522.5880	ITT	R&S-ZCHNG. 522.5880	649.4070.01
R1	RS 0,5W5KOHM10% +LOG POTENTIOMETER	645.8141	DRALORIC	61HF 5KOHM+-10% LOG.	649.4070.01
R2	RS 5K 10% LIN 0,5W POTENTIOMETER	645.8135	DRALORIC	61CF 5KOHM+-10% LIN.	649.4070.01
S1	SK KIPPSCH. 1POL. UM MINIAT TOGGLE SWITCH	586.9070	APR	R&S-ZCHNG. 586.9070	649.4070.01
X22	BESTEHT AUS/CONSISTING OF EINSATZ FP242.3580 GEHAEUSE FP087.9028 VERRIEGELUNG FP099.4432				649.4505
					- ENDE -

ROHDE & SCHWARZ	Äl	Datum Date	Schalteilliste für Parts list for	Sachnummer Stock No.	Blatt Page
	14	1092	GB853C1 BEDIENGERAET GB853C1 CONTROL UNIT	649.4011.01 SA	2-



ROHDE & SCHWARZ

ÄZ Datum
Date
03 0484

Schaltteilliste für
Parts list for
ED TASTENPLATTE
KEYBOARD PCB

Sachnummer
Stock No.

649.4111.01 SA

Blatt
Page

1

Kennzeichen Component No.	Benennung/Beschreibung Designation	Sachnummer Stock No.	enthalten in contained in
<p>.</p> <p>X11</p>	<p>VARIANTENERKL. / VERSIONS VAR 02 = GRUNDAUSFUEHRUNG MOD 02 = BASIC MODEL</p> <p>FP STECKERLEISTE 16POL. 16-PIN INSERT ANSLEY 609-M165</p>	<p>FP 278.4212</p>	<p>649.4263</p> <p>- ENDE -</p>

649.4111 01 SA BL 1-

Für diese Unterlage behalten wir
uns alle Rechte vor

**ROHDE & SCHWARZ**

ÄZ	Datum
05	0285

 Schalteilliste für
 Parts list for
**ED FILTERPLATTE
 FILTER**

 Sachnummer
 Stock No.

649.4157.01 SA

Blatt
Page

1

Kennzeichen Component No.	Benennung/Beschreibung Designation	Sachnummer Stock No.	enthalten in contained in
-	VARIANTENERKL. / VERSIONS VAR 02 = GRUNDAUSFUEHRUNG MOD 02 = BASIC MODEL		
C1	CC 2,2NF+-10%50VX7R 1206 CERAMIC CHIP CAPACITOR VITRAMON VJ1206Y222KFA	CC 099.8444	
BIS/TO			
C5			
C6	CC 22NF+-10%50VX7R 1206 CERAMIC CHIP CAPACITOR VITRAMON VJ1206Y223KFA	CC 099.8467	
C7	CC 22NF+-10%50VX7R 1206 CERAMIC CHIP CAPACITOR VITRAMON VJ1206Y223KFA	CC 099.8467	
C8	CC 22NF+-10%50VX7R 1206 CERAMIC CHIP CAPACITOR VITRAMON VJ1206Y223KFA	CC 099.8467	
C9	CC 22NF+-10%50VX7R 1206 CERAMIC CHIP CAPACITOR VITRAMON VJ1206Y223KFA	CC 099.8467	
C10	CC 2,2NF+-10%50VX7R 1206 CERAMIC CHIP CAPACITOR VITRAMON VJ1206Y222KFA	CC 099.8444	
L1	LD 150 UH10X15,00HMO,061A CHOKE DELEVAN DROSSEL1025-72	LD 067.3124	
BIS/TO			
L10			
L11	LD DROSSEL CHOKE	547.9850	
L12	LD DROSSEL CHOKE	547.9850	
L13	LD 150 UH10X15,00HMO,061A CHOKE DELEVAN DROSSEL1025-72	LD 067.3124	
L14	LD 150 UH10X15,00HMO,061A CHOKE DELEVAN DROSSEL1025-72	LD 067.3124	
X31	FP BUCHSENLEISTE 10POL. CONNECTOR 10POL. PANDUIT 050A-010-435A	FP 649.4434	649.4257
X32	FO EINBAUDOSE 10P.NF10/L CONNECTOR 10POL. SCHALTBAU NF10/L 14350551280	645.8158	
X33	FO EINBAUDOSE 10P.NF10/L CONNECTOR 10POL. SCHALTBAU NF10/L 14350551280	645.8158	
Z1	LD 10GHZ 50DB100V10A4RDX9 LEAD THROUGH FILTER ERIE R&S-ZCHNG.451.4636	LD 451.4636	

649.4157.01 SA BL 1+



ROHDE & SCHWARZ

ÄZ

Datum
Date

05

0285

Schaltteilliste für
Parts list for
**ED FILTERPLATTE
FILTER**

Sachnummer
Stock No.

649.4157.01 SA

Blatt
Page

2

Kennzeichen Component No.	Benennung/Beschreibung Designation	Sachnummer Stock No.	enthalten in contained in
BIS/TO Z8			- ENDE -

Für diese Unterlage behalten wir uns alle Rechte vor

Kennz. Comp.No.	Benennung Designation	Sachnummer Stock No.	Hersteller Manufacturer	Bezeichnung Designation	enthalten in contained in
	VARIANTENERKL. / VERSIONS VAR 02 = GRUNDAUSFUEHRUNG MOD 02 = BASIC MODEL				
A41	ENTHALTEN IN/INCLUDED IN 649.4011				
B1	EQ 6,144 MHZ CL30PF HC43U QUARTZ CRYSTAL UNIT	EQ 091.0221		KRISTALLVE N. R&S SACHNUMMER	
C1	CK 1UF+-10%50V RD5,5H11,5 CAPACITOR	CK 099.2998	WIMA	MKS2/50/1UF/10%	
C2	CC 100NF+-10%50V5K1200VIE CAPACITOR	CC 084.5350	UNION CARB	CK05BX104K	
C3	CC 100NF+-10%50V5K1200VIE CAPACITOR	CC 084.5350	UNION CARB	CK05BX104K	
C4	CC 5 PF+-0,5 PF5P100 CERAMIC CAPACITOR	006.0083	DRALORIC	P100/IB5/0,5SDPN	
C5	CC 100NF+-10%50V5K1200VIE CAPACITOR	CC 084.5350	UNION CARB	CK05BX104K	
C6	CC 100NF+-10%50V5K1200VIE CAPACITOR	CC 084.5350	UNION CARB	CK05BX104K	
C7	CC 100NF+-10%50V5K1200VIE CAPACITOR	CC 084.5350	UNION CARB	CK05BX104K	
C8	CC 220PF+-10%200V K1200VI CAPACITOR	CC 060.1078	UNION CARB	CK05BX221K	
C9	CC 100PF+-10%200V5K1200VI CAPACITOR	CC 084.5250	UNION CARB	CK05BX101K	
C10	CC 220PF+-10%200V K1200VI CAPACITOR	CC 060.1078	UNION CARB	CK05BX221K	
C11	CC 100PF+-10%200V5K1200VI CAPACITOR	CC 084.5250	UNION CARB	CK05BX101K	
C12	CC 100NF+-10%50V5K1200VIE CAPACITOR	CC 084.5350	UNION CARB	CK05BX104K	
C13	CC 100NF+-10%50V5K1200VIE CAPACITOR	CC 084.5350	UNION CARB	CK05BX104K	
C14	CC 100NF+-10%50V5K1200VIE CAPACITOR	CC 084.5350	UNION CARB	CK05BX104K	
C15	CC 1NF+-10%200V5K1200VIEL CAPACITOR	CC 068.4047	UNION CARB	CK05BX102K	
C16	CC 1NF+-10%200V5K1200VIEL CAPACITOR	CC 068.4047	UNION CARB	CK05BX102K	
C17	CC 1NF+-10%200V5K1200VIEL CAPACITOR	CC 068.4047	UNION CARB	CK05BX102K	
C18	CC 1NF+-10%200V5K1200VIEL CAPACITOR	CC 068.4047	UNION CARB	CK05BX102K	
C19	CC 1NF+-10%200V5K1200VIEL CAPACITOR	CC 068.4047	UNION CARB	CK05BX102K	
C20	CC 1NF+-10%200V5K1200VIEL CAPACITOR	CC 068.4047	UNION CARB	CK05BX102K	
C21	CC 10NF+-10%100V5K1200VIE CERAMIC CAPACITOR	CC 068.4060	UNION CARB	CK05BX103K	
C30	CC 100NF+-10%50V5K1200VIE CAPACITOR	CC 084.5350	UNION CARB	CK05BX104K	
C31	CC 100NF+-10%50V5K1200VIE CAPACITOR	CC 084.5350	UNION CARB	CK05BX104K	
C32	CC 1NF+-10%200V5K1200VIEL CAPACITOR	CC 068.4047	UNION CARB	CK05BX102K	
C33	CC 1NF+-10%200V5K1200VIEL CAPACITOR	CC 068.4047	UNION CARB	CK05BX102K	
C34	CC 10NF+-10%100V5K1200VIE CERAMIC CAPACITOR	CC 068.4060	UNION CARB	CK05BX103K	
C50	CE 100UF-10+50% 25V 13X13 ELECTROLYTIC CAPACITOR	CE 208.4007	ROEDERST	ELK0EK100/25	
C51	CE 100UF-10+50% 25V 13X13 ELECTROLYTIC CAPACITOR	CE 208.4007	ROEDERST	ELK0EK100/25	
C52	CE 100UF-10+50% 25V 13X13 ELECTROLYTIC CAPACITOR	CE 208.4007	ROEDERST	ELK0EK100/25	
C53	CE 100UF-10+50% 25V 13X13 ELECTROLYTIC CAPACITOR	CE 208.4007	ROEDERST	ELK0EK100/25	
C54	CE 6,8UF+-20%10V 5X2X6 ELECTROLYTIC CAPACITOR	CE 087.5868	TEKELEC	MT2R6,8UF10V20%	
C55	CC 100PF+-10%200V5K1200VI CAPACITOR	CC 084.5250	UNION CARB	CK05BX101K	
C56	CE 1000UF10+50% 16V 15X30 ELECTROLYTIC CAPACITOR	CE 087.0437	ROEDERST	ELKD EK 1000/16	

ROHDE & SCHWARZ

Äl Datum
18:0291

Schaltteilliste für
Parts list for

Sachnummer
Stock No.

Blatt
Page

EE PROZESSORPLATTE
PROCESSOR

649.4170.01 SA

1+

Kennz. Comp.No.	Benennung Designation	Sachnummer Stock No.	Hersteller Manufacturer	Bezeichnung Designation	enthalten in contained in
D1	BC MSM80C85A 8B.CPU CPU	633.9019	OKI	MSM80C85ARS	
D2	BL MM74HC138N 3/8L.DECOD 3-TO-8 LINE DECODER	BL 571.3165	MOTOROLA	MC74HC138N	
D3	BL MM74HC373N 8XD-LATCH OCTAL D-TYPE LATCH TRIST.	BL 645.6726	TEXAS	SN74HC373N	
D6	BC MSM82C51A PR.COMM.IF PROGR.COMMUNIC.INTERFACE	BC 586.9987	OKI	MSM82C51A	
D7	BL MM74C914N 6XSCHM.TRIG HEX SCHMITT TRIGGER	282.3423	NSC	MM74C914N	
D8	BL CD4066BE 4XANALOGSCH ANALOG SWITCH	290.3906	RCA	CD4066BE	
D9	BL CD4030BE 4X2IN.EXORG EXOR GATE	086.7173	RCA	CD4030BE	
D10	BC MSM82C59A INTERR.CONTR INTERRUPT CONTROLLER	BC 006.9597	OKI	MSM82C59A	
D11	BJ AM26LS30DM 2XLINE DRIV LINE DRIVER	BJ 565.1487	NSC	DS1691J	
D12	BJ DS26LS32MJ 4XLINE REC LINE RECEIVER	565.1470	NAT. SEMIC	DS96F173MJ	
D13	BC MSM81C55RS I/O+TIM+RAM 2K-RAM INPUT/OUTPUT	BC 633.9025	OKI	MSM81C55RS	
D14	BC MSM81C55RS I/O+TIM+RAM 2K-RAM INPUT/OUTPUT	BC 633.9025	OKI	MSM81C55RS	
D15	BL CD4082BE 2X4INP.ANDG AND GATE	299.6889	RCA	CD4082BE	
D16	BL CD4071BE 4X2IN. ORG OR GATE	299.6866	RCA	CD4071BE	
D17	BL CD4012BE 2X4IN.NANDG NAND GATE	086.7015	RCA	CD4012BE	
D18	BO UA723DM ADJOA1 VREGL VOLTAGE REGULATOR	283.9425	RAYTHEON	RM-723D	
D19	BL CD4071BE 4X2IN. ORG OR GATE	299.6866	RCA	CD4071BE	
K1	SN HERMET 5V 2UM MINI RELAY	562.6607	ITT	4851721400	
R1	RL 0,60W 562 KOHM+-1%TK50 RESISTOR	RL 083.2664	DRALORIC	SMAO207/562K-F-C	
R2	RL 0,60W 10,0KOHM+-1%TK50 RESISTOR	RL 083.1297	DRALORIC	SMAO207/10K-F-D	
R3	RL 0,60W 10,0KOHM+-1%TK50 RESISTOR	RL 083.1297	DRALORIC	SMAO207/10K-F-D	
R4	RL 0,60W 10,0KOHM+-1%TK50 RESISTOR	RL 083.1297	DRALORIC	SMAO207/10K-F-D	
R5	RL 0,60W 10,0KOHM+-1%TK50 RESISTOR	RL 083.1297	DRALORIC	SMAO207/10K-F-D	
R6	RL 0,60W 1KOHM+-1%TK50 RESISTOR	RL 082.2160	DRALORIC	SMAO207/1K-F-C	
R10	RL 0,60W 10,0KOHM+-1%TK50 RESISTOR	RL 083.1297	DRALORIC	SMAO207/10K-F-D	
R11	RL 0,60W 56,2KOHM+-1%TK50 RESISTOR	RL 082.2231	DRALORIC	SMAO207/56,2K-F-C	
R12	RL 0,60W 10,0KOHM+-1%TK50 RESISTOR	RL 083.1297	DRALORIC	SMAO207/10K-F-D	
R13	RL 0,60W 10,0KOHM+-1%TK50 RESISTOR	RL 083.1297	DRALORIC	SMAO207/10K-F-D	
R14	RL 0,60W 10,0KOHM+-1%TK50 RESISTOR	RL 083.1297	DRALORIC	SMAO207/10K-F-D	
R15	RL 0,60W 12,1KOHM+-1%TK50 RESISTOR	RL 083.1351	DRALORIC	SMAO207/12,1K-F-D	
R16	RL 0,60W 12,1KOHM+-1%TK50 RESISTOR	RL 083.1351	DRALORIC	SMAO207/12,1K-F-D	
R17	RL 0,60W 12,1KOHM+-1%TK50 RESISTOR	RL 083.1351	DRALORIC	SMAO207/12,1K-F-D	
R18	RL 0,60W 12,1KOHM+-1%TK50 RESISTOR	RL 083.1351	DRALORIC	SMAO207/12,1K-F-D	
R19	RL 0,60W 1KOHM+-1%TK50 RESISTOR	RL 082.2160	DRALORIC	SMAO207/1K-F-C	
R20	RL 0,60W 100 OHM+-1%TK50 RESISTOR	RL 082.6543	DRALORIC	SMAO207/100/HM-F-D	
R21	RL 0,60W 10,0KOHM+-1%TK50 RESISTOR	RL 083.1297	DRALORIC	SMAO207/10K-F-D	
R22	RL 0,60W 100 OHM+-1%TK50 RESISTOR	RL 082.6543	DRALORIC	SMAO207/100/HM-F-D	
R28	RL 0,60W 10,0KOHM+-1%TK50 RESISTOR	RL 083.1297	DRALORIC	SMAO207/10K-F-D	

ROHDE & SCHWARZ	Äl	Datum Date	Schaltteilliste für Parts list for	Sachnummer Stock No.	Blatt Page
	18	0291	EE PROZESSORPLATTE PROCESSOR	649.4170.01 SA	2+

Für diese Unterlage behalten wir uns alle Rechte vor

Kennz. Comp.No.	Benennung Designation	Sachnummer Stock No.	Hersteller Manufacturer	Bezeichnung Designation	enthalten in contained in
R29	RL 0,60W 10,0KOHM+-1%TK50 RESISTOR	RL 083.1297	DRALORIC	SMA0207/10K-F-D	
R30	RN 9X 10KOHM+-SIL10 H5 RESISTOR NETWORK	RN 343.4523	BOURNS	4310R-101-103	
R31	RN 5X 10KOHM+-2%SIL 6 H5 RESISTOR NETWORK	RN 099.2675	BOURNS	4306R-101-103	
R32	RN 9X 10KOHM+-SIL10 H5 RESISTOR NETWORK	RN 343.4523	BOURNS	4310R-101-103	
R33	RN 9X 10KOHM+-SIL10 H5 RESISTOR NETWORK	RN 343.4523	BOURNS	4310R-101-103	
R34	RN 5X 10KOHM+-2%SIL 6 H5 RESISTOR NETWORK	RN 099.2675	BOURNS	4306R-101-103	
R35	RN 5X 10KOHM+-2%SIL 6 H5 RESISTOR NETWORK	RN 099.2675	BOURNS	4306R-101-103	
R39	RL 0,60W 100KOHM+-1%TK50 RESISTOR	RL 082.1764	DRALORIC	SMA0207/100K-F-C	
R40	RL 0,60W 4,75KOHM+-1%TK50 RESISTOR	RL 083.1097	DRALORIC	SMA0207/4,75K-F-D	
R41	RL 0,60W 56,2KOHM+-1%TK50 RESISTOR	RL 082.2231	DRALORIC	SMA0207/56,2K-F-C	
R42	RL 0,60W 100KOHM+-1%TK50 RESISTOR	RL 082.1764	DRALORIC	SMA0207/100K-F-C	
R43	RL 0,60W 5,62KOHM+-1%TK50 RESISTOR	RL 082.2190	DRALORIC	SMA0207/5,62K-F-C	
R44	RL 0,60W 4,75KOHM+-1%TK50 RESISTOR	RL 083.1097	DRALORIC	SMA0207/4,75K-F-D	
R45	RL 0,60W 56,2KOHM+-1%TK50 RESISTOR	RL 082.2231	DRALORIC	SMA0207/56,2K-F-C	
R50	RL 0,60W 562 OHM+-1%TK50 RESISTOR	RL 083.0461	DRALORIC	SMA0207/562OHM-F-D	
R51	RL 0,60W 1,21KOHM+-1%TK50 RESISTOR	RL 083.0655	DRALORIC	SMA0207/1,21K-F-D	
R52	RS 0,5W1KOHM+-10%10X10X5 CERMET POTENTIOMETER T	RS 087.7560	BOURNS	3386F-1-102	
R53	RL 0,60W 4,75KOHM+-1%TK50 RESISTOR	RL 083.1097	DRALORIC	SMA0207/4,75K-F-D	
R54	RL 0,60W 1KOHM+-1%TK50 RESISTOR	RL 082.2160	DRALORIC	SMA0207/1K-F-C	
S1	SK CODIERSCH.DIL.4-POLIG ROCKER DIP SWITCH	SK 591.3002	GRAYHILL	76 YY 22894-S	
V1	AD 1N4448 75V UDI DIODE	AD 012.0700	TEXAS INST	1N4448 GEGURTET	
V2	AK BCY79IX P 45V 200MA TRANSISTOR	AK 010.3777	PHILIPS-CO	BCY79IX	
V3	AD 1N4448 75V UDI DIODE	AD 012.0700	TEXAS INST	1N4448 GEGURTET	
V4	AD 1N4448 75V UDI DIODE	AD 012.0700	TEXAS INST	1N4448 GEGURTET	
V50	AE BZX85/C8V2 1,3W ZDI ZENER DIODE	AE 092.8526	THOMSON	BZX85/C8V2	
V51	AE BZX85/C18 1,3W ZDI ZENER DIODE	AE 092.8310	THOMSON	BZX85/C18	
V52	AE BZX85/C6V8 1,3W ZDI ZENER DIODE	AE 092.8255	THOMSON	BZX85/C6V8	
V53	AE BZX85/C18 1,3W ZDI ZENER DIODE	AE 092.8310	THOMSON	BZX85/C18	
V54	AD BAV21 250V UDI DIODE	AD 082.6837	INTERMETAL	BAV21	
V55	ZM TRANSISTOR TRANSISTOR BEARBEITET AUS/ CONDITIONED OUT OF	649.4305			
V56	AE BZX85/C6V2 1,3W ZDI ZENER DIODE	AE 092.8249	THOMSON	BZX85/C6V2	
V57	AD 1N4448 75V UDI DIODE	AD 012.0700	TEXAS INST	1N4448 GEGURTET	
X9	FP STIFTELEISTE 36P.R2,54 PIN CONNECTOR	FP 242.3600	BINDER	742-5-11-0178-00-36	
X41	FP STECKERL.INDIR.64POLIG 64-PIN INSERT	FP 084.6470	PANDUIT	100-064-033/999	
X1041 . .1049 X104.1	FP KURZSCHLUSSBUCHSE SHORTING PLUG	FP 491.7042	PK	452-70302	
	FP STIFTELEISTE 36P.R2,54 PIN CONNECTOR	FP 242.3600	BINDER	742-5-11-0178-00-36	

ROHDE & SCHWARZ	Äl	Datum Date	Schaltteilliste für Parts list for	Sachnummer Stock No.	Blatt Page
	18	0291	EE PROZESSORPLATTE PROCESSOR	649.4170.01 SA	3+

Kennz. Comp.No.	Benennung Designation	Sachnummer Stock No.	Hersteller Manufacturer	Bezeichnung Designation	enthalten in contained in
X104.2	3-POLIG FP STIFTELEISTE 36P.R2,54 PIN CONNECTOR	FP 242.3600	BINDER	742-5-11-0178-00-36	
X104A	3-POLIG FP STIFTELEISTE 36P.R2,54 PIN CONNECTOR	FP 242.3600	BINDER	742-5-11-0178-00-36	
X104B	7-POLIG FP STIFTELEISTE 36P.R2,54 PIN CONNECTOR	FP 242.3600	BINDER	742-5-11-0178-00-36	
X104C	7-POLIG FP STIFTELEISTE 36P.R2,54 PIN CONNECTOR	FP 242.3600	BINDER	742-5-11-0178-00-36	
					- ENDE -

ROHDE & SCHWARZ	Äl	Datum Date	Schaltteilliste für Parts list for	Sachnummer Stock No.	Blatt Page
	18	0291	EE PROZESSORPLATTE PROCESSOR	649.4170.01 SA	4-

Für diese Unterlage behalten wir uns alle Rechte vor

Kennz. Comp.No.	Benennung Designation	Sachnummer Stock No.	Hersteller Manufacturer	Bezeichnung Designation	enthalten in contained in
	VARIANTENERKL. / VERSIONS VAR 02 = GRUNDAUSFUEHRUNG MOD 02 = BASIC MODEL VAR 03 = MARINEVERSION MOD 03 = NAVY VERSION				
C1	CC 10NF+-10%100V5K1200VIE CERAMIC CAPACITOR	CC 068.4060	UNION CARB	CK05BX103K	
C2	CC 10NF+-10%100V5K1200VIE CERAMIC CAPACITOR	CC 068.4060	UNION CARB	CK05BX103K	
C3	CE 33 UF+-20%10V 7X 5X11 ELECTROLYTIC CAPACITOR	CE 087.0343	ROEDERSTEI	ETR 3 33/10 20%	
C4	CC 1UF+-10%50V7K1200VIEL CAPACITOR	084.5538	UNION CARB	CK06BX105K	
C5	CC 470PF+-10%200V5K1200VI CAPACITOR	CC 060.2274	UNION CARB	CK 05 BX 471K	
C6	CE 4,7UF+-20%35V 7X 5X11 ELECTROLYTIC CAPACITOR	CE 022.8204	ROEDERSTEI	ETR 3 4,7/40 20%	
C7	CC 100PF+-10%200V5K1200VI CAPACITOR	CC 084.5250	UNION CARB	CK05BX101K	
C8	CE 15 UF+-20%20V 7X 5X11 ELECTROLYTIC CAPACITOR	CE 022.8127	ROEDERSTEI	ETR-3 15/20 20%	
C9	CC 10NF+-10%100V5K1200VIE CERAMIC CAPACITOR	CC 068.4060	UNION CARB	CK05BX103K	
C10	CC 100NF+-10%50V5K1200VIE CAPACITOR	CC 084.5350	UNION CARB	CK05BX104K	
C16	CC 10NF+-10%100V5K1200VIE CERAMIC CAPACITOR	CC 068.4060	UNION CARB	CK05BX103K	
C17	CC 100PF+-10%200V5K1200VI CAPACITOR	CC 084.5250	UNION CARB	CK05BX101K	
C18	CC 1NF+-10%200V5K1200VIEL CAPACITOR	CC 068.4047	UNION CARB	CK05BX102K	
C19	CC 10NF+-10%100V5K1200VIE CERAMIC CAPACITOR	CC 068.4060	UNION CARB	CK05BX103K	
C20	CC 1NF+-10%200V5K1200VIEL CAPACITOR	CC 068.4047	UNION CARB	CK05BX102K	
C21	CC 100NF+-10%50V5K1200VIE CAPACITOR	CC 084.5350	UNION CARB	CK05BX104K	
C24	CC 100NF+-10%50V5K1200VIE CAPACITOR	CC 084.5350	UNION CARB	CK05BX104K	
C25	CC 10NF+-10%100V5K1200VIE CERAMIC CAPACITOR	CC 068.4060	UNION CARB	CK05BX103K	
C26	CC 12NF+-10%50V5K1200VIEL CAPACITOR	* 082.7610	UNION CARB	CK05BX123K	
C27	CC 10NF+-10%100V5K1200VIE CERAMIC CAPACITOR	CC 068.4060	UNION CARB	CK05BX103K	
C28	CC 100NF+-10%50V5K1200VIE CAPACITOR	CC 084.5350	UNION CARB	CK05BX104K	
C29	CC 100NF+-10%50V5K1200VIE CAPACITOR	CC 084.5350	UNION CARB	CK05BX104K	
C30	CE 4,7UF+-20%35V 7X 5X11 ELECTROLYTIC CAPACITOR	CE 022.8204	ROEDERSTEI	ETR 3 4,7/40 20%	
C31	CC 68PF+-10%200V5K1200VIE CAPACITOR	CC 084.5238	UNION CARB	CK05BX680K	
C36	CE 2,2UF+-20%20V 5X 4X 7 ELECTROLYTIC CAPACITOR	CE 022.8104	ROEDERSTEI	ETR 1 2,2/20 20%	
C37	CE 4,7UF+-20%35V 7X 5X11 ELECTROLYTIC CAPACITOR	CE 022.8204	ROEDERSTEI	ETR 3 4,7/40 20%	
C38	CC 1UF+-10%50V7K1200VIEL CAPACITOR	084.5538	UNION CARB	CK06BX105K	
C40	CE 4,7UF+-20%35V 7X 5X11 ELECTROLYTIC CAPACITOR	CE 022.8204	ROEDERSTEI	ETR 3 4,7/40 20%	
C41	CC 10NF+-10%100V5K1200VIE CERAMIC CAPACITOR	CC 068.4060	UNION CARB	CK05BX103K	
C42	CC 10NF+-10%100V5K1200VIE CERAMIC CAPACITOR	CC 068.4060	UNION CARB	CK05BX103K	
C43	CC 2,2NF+-10%100V5K1200VI CERAMIC CAPACITOR	CC 067.9022	UNION CARB	CK05BX222K	
C44	CC 100NF+-10%50V5K1200VIE CAPACITOR	CC 084.5350	UNION CARB	CK05BX104K	
C45	CC 10NF+-10%100V5K1200VIE CERAMIC CAPACITOR	CC 068.4060	UNION CARB	CK05BX103K	
C46	CE 100UF+-20%20V12X12X11 ELECTROLYTIC CAPACITOR	CE 022.8140	ROEDERSTEI	ETR 5 100/20 20%	
C47	CC 100NF+-10%50V5K1200VIE CAPACITOR	CC 084.5350	UNION CARB	CK05BX104K	
C48	CE 15 UF+-20%20V 7X 5X11 ELECTROLYTIC CAPACITOR	CE 022.8127	ROEDERSTEI	ETR-3 15/20 20%	

ROHDE & SCHWARZ

Äl Datum
Date

32 1092

Schaltteilliste für
Parts list for

EE AUDIOPLATTE
AUDIO BOARD

Sachnummer
Stock No.

649.4192.01 SA

Blatt
Page

1+

Kennz. Comp.No.	Benennung Designation	Sachnummer Stock No.	Hersteller Manufacturer	Bezeichnung Designation	enthalten in contained in
C49	CE 47 UF+-20% 6V 7X 5X11 ELECTROLYTIC CAPACITOR	CE 022.8040	ROEDERSTEI	ETR 3 47/6,3 20%	
C50	CC 330NF+-10% 50V8K1200VI CAPACITOR	082.7740	UNION CARB	CK06BX334K	
C51	CC 4,7NF+-10%100V5K1200VI CERAMIC CAPACITOR	CC 068.4053	UNION CARB	CK 05 BX 472K	
C56	CE 100UF+-20%20V12X12X11 ELECTROLYTIC CAPACITOR	CE 022.8140	ROEDERSTEI	ETR 5 100/20 20%	
C57	CE 22 UF+-20%35V12X 7X11 ELECTROLYTIC CAPACITOR	CE 022.8227	ROEDERSTEI	ETR 4 22/40 20%	
C58	CC 100NF+-10%50V5K1200VIE CAPACITOR	CC 084.5350	UNION CARB	CK05BX104K	
C59	CC 2,2NF+-10%100V5K1200VI CERAMIC CAPACITOR	CC 067.9022	UNION CARB	CK05BX222K	
C60	CC 10NF+-10%100V5K1200VIE CERAMIC CAPACITOR	CC 068.4060	UNION CARB	CK05BX103K	
C61	CC 100NF+-10%50V5K1200VIE CAPACITOR	CC 084.5350	UNION CARB	CK05BX104K	
C62	CE 15 UF+-20%20V 7X 5X11 ELECTROLYTIC CAPACITOR	CE 022.8127	ROEDERSTEI	ETR-3 15/20 20%	
C63	CE 47 UF+-20% 6V 7X 5X11 ELECTROLYTIC CAPACITOR	CE 022.8040	ROEDERSTEI	ETR 3 47/6,3 20%	
C64	CC 330NF+-10% 50V8K1200VI CAPACITOR	082.7740	UNION CARB	CK06BX334K	
C65	CC 10NF+-10%100V5K1200VIE CERAMIC CAPACITOR	CC 068.4060	UNION CARB	CK05BX103K	
C71	CC 10NF+-10%100V5K1200VIE CERAMIC CAPACITOR	CC 068.4060	UNION CARB	CK05BX103K	
C72	CC 1NF+-10%200V5K1200VIEL CAPACITOR	CC 068.4047	UNION CARB	CK05BX102K	
C73	CC 1NF+-10%200V5K1200VIEL CAPACITOR	CC 068.4047	UNION CARB	CK05BX102K	
C74	CC 1NF+-10%200V5K1200VIEL CAPACITOR	CC 068.4047	UNION CARB	CK05BX102K	
C75	CC 10NF+-10%100V5K1200VIE CERAMIC CAPACITOR	CC 068.4060	UNION CARB	CK05BX103K	
C130	CC 1NF+-10%200V5K1200VIEL CAPACITOR	CC 068.4047	UNION CARB	CK05BX102K	
C131	CC 1NF+-10%200V5K1200VIEL CAPACITOR	CC 068.4047	UNION CARB	CK05BX102K	
C132	CC 2,2NF+-10%100V5K1200VI CERAMIC CAPACITOR	CC 067.9022	UNION CARB	CK05BX222K	
C133	CC 1NF+-10%200V5K1200VIEL CAPACITOR	CC 068.4047	UNION CARB	CK05BX102K	
C134	CC 1NF+-10%200V5K1200VIEL CAPACITOR	CC 068.4047	UNION CARB	CK05BX102K	
C135	CC 1NF+-10%200V5K1200VIEL CAPACITOR	CC 068.4047	UNION CARB	CK05BX102K	
C136	CC 1UF+-10%50V7K1200VIEL CAPACITOR	084.5538	UNION CARB	CK06BX105K	
C145	CC 100PF+-10%200V5K1200VI CAPACITOR	CC 084.5250	UNION CARB	CK05BX101K	
C146	CE 330UF+-20%20V7,3X19 FL ELECTROLYTIC CAPACITOR	581.0575	HUGHES	69FE2231 M7	
C147	CC 100NF+-10%50V5K1200VIE CAPACITOR	CC 084.5350	UNION CARB	CK05BX104K	
C148	CC 330PF+-10%200V K1200VI CAPACITOR	CC 060.1090	UNION CARB	CK05BX331K	
C149	CC 1UF+-10%50V7K1200VIEL CAPACITOR	084.5538	UNION CARB	CK06BX105K	
C150	CE 4,7UF+-20%35V 7X 5X11 ELECTROLYTIC CAPACITOR	CE 022.8204	ROEDERSTEI	ETR 3 4,7/40 20%	
C151	CE 4,7UF+-20%35V 7X 5X11 ELECTROLYTIC CAPACITOR	CE 022.8204	ROEDERSTEI	ETR 3 4,7/40 20%	
C152	CC 1UF+-10%50V7K1200VIEL CAPACITOR	084.5538	UNION CARB	CK06BX105K	
C153	CC 100NF+-10%50V5K1200VIE CAPACITOR	CC 084.5350	UNION CARB	CK05BX104K	
C154	CC 100NF+-10%50V5K1200VIE CAPACITOR	CC 084.5350	UNION CARB	CK05BX104K	
C155	CE 4,7UF+-20%35V 7X 5X11 ELECTROLYTIC CAPACITOR	CE 022.8204	ROEDERSTEI	ETR 3 4,7/40 20%	
C156	CE 4,7UF+-20%35V 7X 5X11 ELECTROLYTIC CAPACITOR	CE 022.8204	ROEDERSTEI	ETR 3 4,7/40 20%	
D1	BL CD4001BE 4X2INP.NORG NOR GATE	086.6960	RCA	CD4001BE	

ROHDE & SCHWARZ	AI	Datum Date	Schaltteilliste für Parts list for	Sachnummer Stock No.	Blatt Page
	32	1092			

Für diese Unterlage behalten wir uns alle Rechte vor

Kennz. Comp.No.	Benennung Designation	Sachnummer Stock No.	Hersteller Manufacturer	Bezeichnung Designation	enthalten in contained in
D2	BL MC14490EVL 6XKONT.ENTP IC 6XKONT.ENTP. MC14490	522.4384	MOTOROLA	MC14490EVL	
D3	BL HEF4011BP 4X2IN.NANDG NAND GATE	565.1670	PHILIPS-CO	HEF4011BP	
D4	BL CD4071BE 4X2IN. ORG OR GATE	299.6866	RCA	CD4071BE	
D5	BL CD4047BE MULTIVIBR. MULTIVIBRATOR	349.2980	RCA	CD4047BE	
D6	BL CD4013BE 2XD- FLIPFL FLIPFLOP	086.7021	RCA	CD4013BE	
D7	BL CD4066BE 4XANALOGSCH ANALOG SWITCH	290.3906	RCA	CD4066BE	
D8	BL MC14538BCP 2X MONOFLOP MONOSTABLE MULTIVIBRATOR	252.7389	MOTOROLA	MC14538BCP	
K1	SN HERMET.DIL-GEHAEUSE RELAY	SN 470.6299	SDS	DX2-5V	
L1	LD 100 UH10%8,000HMO,084A CHOKE	LD 067.3101	DELEVAN	DROSSEL1025-68	
L2	LD 100 UH10%8,000HMO,084A CHOKE	LD 067.3101	DELEVAN	DROSSEL1025-68	
L3	LD 100 UH10%8,000HMO,084A CHOKE	LD 067.3101	DELEVAN	DROSSEL1025-68	
L4	LD 100 UH10%8,000HMO,084A CHOKE	LD 067.3101	DELEVAN	DROSSEL1025-68	
L5	LD 56UH 1,5A 0,30HM CHOKE	LD 099.5197	SIEMENS	B 82111-E-C24	
L6	LD 100 UH10%8,000HMO,084A CHOKE	LD 067.3101	DELEVAN	DROSSEL1025-68	
L7	LD 100 UH10%8,000HMO,084A CHOKE	LD 067.3101	DELEVAN	DROSSEL1025-68	
L8	LD SPULE COIL	649.4470			
N1	BO TLO74IN LN 4XFET OPAMP OPERATIONAL AMPLIFIER	568.7528	TEXAS INST	TLO74IN	
N2	BO TLO74IN LN 4XFET OPAMP OPERATIONAL AMPLIFIER	568.7528	TEXAS INST	TLO74IN	
N3	BO TLO74IN LN 4XFET OPAMP OPERATIONAL AMPLIFIER	568.7528	TEXAS INST	TLO74IN	
N4	BO TLO74IN LN 4XFET OPAMP OPERATIONAL AMPLIFIER	568.7528	TEXAS INST	TLO74IN	
N5	BJ AM26LS30DM 4X RS422 TX QUAD RS422 LINE DRIVER	BJ 565.1487	NSC	DS1691J	
N6	BO TBA810AS LF 5.0W AMPL POWER AMPLIFIER	645.8312	AEG-TELEF	TBA810AS	F
N6	BO TBA810AS LF 5.0W AMPL POWER AMPLIFIER	645.8312	AEG-TELEF	TBA810AS	F
N7	BO TBA810AS LF 5.0W AMPL POWER AMPLIFIER	645.8312	AEG-TELEF	TBA810AS	
N7	BO TBA810AS LF 5.0W AMPL POWER AMPLIFIER	645.8312	AEG-TELEF	TBA810AS	
N10	BJ DS26LS32MJ 4X RS422 RX LINE RECEIVER	565.1470	NAT. SEMIC	DS96F173MJ	
N11	BJ AM26LS30DM 4X RS422 TX QUAD RS422 LINE DRIVER	BJ 565.1487	NSC	DS1691J	
N12	BJ MM88C29N 4XLINE DRIV LINE DRIVER	586.7778	NSC	MM88C29N	
R1	RL 0,60W 1KOHM+-1%TK50 RESISTOR	RL 082.2160	DRALORIC	SMA0207/1K-F-C	
R2	RL 0,60W 47,5 OHM+-1%TK50 RESISTOR	RL 082.9507	DRALORIC	SMA0207/47,5OHM-F-D	
R3	RL 0,60W 1KOHM+-1%TK50 RESISTOR	RL 082.2160	DRALORIC	SMA0207/1K-F-C	
R4	RL 0,60W 150 OHM+-1%TK50 RESISTOR	RL 082.9942	DRALORIC	SMA0207/150OHM-F-D	
R5	RL 0,60W 5,62KOHM+-1%TK50 RESISTOR	RL 082.2190	DRALORIC	SMA0207/5,62K-F-C	
R6	RL 0,60W 100KOHM+-1%TK50 RESISTOR	RL 082.1764	DRALORIC	SMA0207/100K-F-C	
R7	RL 0,40W 10,0KOHM+-1%TK50 RESISTOR	RL 092.1567	RESISTA	MK1 10K 1% TK50	
R8	RL 0,60W 1MOHM+-1%TK50 RESISTOR	RL 082.7862	DRALORIC	SMA0207/1M-F-D	
R9	RL 0,60W 3,92KOHM+-1%TK50 RESISTOR	RL 083.1039	RESISTA	MK2	

ROHDE & SCHWARZ	Äl	Datum	Schaltteilliste für Parts list for	Sachnummer Stock No.	Blatt Page
		Date			
	32	1092	EE AUDIOPLATTE AUDIO BOARD	649.4192.01 SA	3+

Kennz. Comp.No.	Benennung Designation	Sachnummer Stock No.	Hersteller Manufacturer	Bezeichnung Designation	enthalten in contained in
R10	RL 0,60W 22,1KOHM+-1%TK50 RESISTOR	RL 083.1545	DRALORIC	SMA/207/22,1K-F-C	
R11	RL 0,60W 10,0KOHM+-1%TK50 RESISTOR	RL 083.1297	DRALORIC	SMA0207/10K-F-D	
R12	RL 0,60W 2,74KOHM+-1%TK50 RESISTOR	RL 083.0926	DRALORIC	SMA0207/2,74K-F-D	
R13	RL 0,60W 10,0KOHM+-1%TK50 RESISTOR	RL 083.1297	DRALORIC	SMA0207/10K-F-D	
R14	RL 0,60W 1MOHM+-1%TK50 RESISTOR	RL 082.7862	DRALORIC	SMA0207/1M-F-D	
R15	RL 0,60W 100 OHM+-1%TK50 RESISTOR	RL 082.6543	DRALORIC	SMA0207/100/HM-F-D	
R17	RL 0,60W 9,09KOHM+-1%TK50 RESISTOR	RL 082.2177	DRALORIC	SMA0207/9,09K-F-C	
R18	RL 0,60W 2,21KOHM+-1%TK50 RESISTOR	RL 082.2477	DRALORIC	SMA 0207/2,21K-F-C	
R19	RL 0,60W 1KOHM+-1%TK50 RESISTOR	RL 082.2160	DRALORIC	SMA0207/1K-F-C	
R20	RL 0,60W 221 KOHM+-1%TK50 RESISTOR	RL 083.2270	DRALORIC	SMA0207/221K-F-C	
R21	RL 0,60W 100KOHM+-1%TK50 RESISTOR	RL 082.1764	DRALORIC	SMA0207/100K-F-C	
R26	RL 0,60W 10,0KOHM+-1%TK50 RESISTOR	RL 083.1297	DRALORIC	SMA0207/10K-F-D	
R27	RL 0,60W 47,5KOHM+-1%TK50 RESISTOR	RL 083.1800	DRALORIC	SMA/207/47,5K-F-C	
R28	RL 0,60W 10,0KOHM+-1%TK50 RESISTOR	RL 083.1297	DRALORIC	SMA0207/10K-F-D	
R29	RL 0,60W 10,0KOHM+-1%TK50 RESISTOR	RL 083.1297	DRALORIC	SMA0207/10K-F-D	
R30	RL 0,60W 10,0KOHM+-1%TK50 RESISTOR	RL 083.1297	DRALORIC	SMA0207/10K-F-D	
R31	RL 0,60W 10,0KOHM+-1%TK50 RESISTOR	RL 083.1297	DRALORIC	SMA0207/10K-F-D	
R32	RL 0,60W 31,6KOHM+-1%TK50 RESISTOR	RL 083.1651	DRALORIC	SMA0207/31,6K-F-C	
R33	RL 0,60W 10,0KOHM+-1%TK50 RESISTOR	RL 083.1297	DRALORIC	SMA0207/10K-F-D	
R34	RL 0,60W 274 OHM+-1%TK50 RESISTOR	RL 083.0178	DRALORIC	SMA0207/274OHM-F-D	
R35	RL 0,60W 332 OHM+-1%TK50 RESISTOR	RL 083.0255	DRALORIC	SMA0207/332OHM-F-D	
R36	RL 0,60W 100KOHM+-1%TK50 RESISTOR	RL 082.1764	DRALORIC	SMA0207/100K-F-C	
R37	RL 0,60W 121 OHM+-1%TK50 RESISTOR	RL 082.9859	DRALORIC	SMA0207/121OHM-F-D	
R41	RL 0,60W 200 OHM+-1%TK50 RESISTOR	RL 083.0049	DRALORIC	SMA0207/200OHM-F-D	
R42	RL 0,60W 825 OHM+-1%TK50 RESISTOR	RL 082.2502	DRALORIC	SMA 0207/825OHM-F-C	
R43	RL 0,60W 200 OHM+-1%TK50 RESISTOR	RL 083.0049	DRALORIC	SMA0207/200OHM-F-D	
R44	RL 0,60W 10,0KOHM+-1%TK50 RESISTOR	RL 083.1297	DRALORIC	SMA0207/10K-F-D	
R45	RL 0,60W 3,32KOHM+-1%TK50 RESISTOR	RL 083.0990	DRALORIC	SMA0207/3,32K-F-D	
R46	RL 0,60W 10,0KOHM+-1%TK50 RESISTOR	RL 083.1297	DRALORIC	SMA0207/10K-F-D	
R47	RL 0,60W 681 OHM+-1%TK50 RESISTOR	RL 083.0490	DRALORIC	SMA0207/681OHM-F-D	
R48	RL 0,60W 562 OHM+-1%TK50 RESISTOR	RL 083.0461	DRALORIC	SMA0207/562OHM-F-D	
R56	RL 0,60W 22,1KOHM+-1%TK50 RESISTOR	RL 083.1545	DRALORIC	SMA/207/22,1K-F-C	
R57	RL 0,60W 10,0KOHM+-1%TK50 RESISTOR	RL 083.1297	DRALORIC	SMA0207/10K-F-D	
R58	RL 0,60W 20,0KOHM+-1%TK50 RESISTOR	RL 083.1522	DRALORIC	SMA/207/20K-F-C	
R59	RL 0,60W 20,0KOHM+-1%TK50 RESISTOR	RL 083.1522	DRALORIC	SMA/207/20K-F-C	
R60	RL 0,60W 200KOHM+-1%TK50 RESISTOR	RL 083.2235	DRALORIC	SMA0207/200K-F-D	
R61	RL 0,60W 35,7KOHM+-1%TK50 RESISTOR	RL 083.1700	DRALORIC	SMA0207/35,7K-F-C	
R62	RL 0,60W 392 KOHM+-1%TK50 RESISTOR	RL 083.2512	DRALORIC	SMA0207/392K-F-C	
R63	RL 0,60W 1,82KOHM+-1%TK50 RESISTOR	RL 082.2277	DRALORIC	SMA0207/1,82K-F-C	

ROHDE & SCHWARZ	AI	Datum Date	Schaltteilliste für Parts list for	Sachnummer Stock No.	Blatt Page
	32	1092	EE AUDIOPLATTE AUDIO BOARD	649.4192.01 SA	4+

Kennz. Comp.No.	Benennung Designation	Sachnummer Stock No.	Hersteller Manufacturer	Bezeichnung Designation	enthalten in contained in
R64	RL 0,60W 33,2KOHM+-1%TK50 RESISTOR	RL 083.1674	DRALORIC	SMA0207/33,2K-F-C	
R65	RL 0,60W 432 KOHM+-1%TK50 RESISTOR	RL 083.2558	DRALORIC	SMA0207/432K-F-C	
R66	RL 0,60W 1MOHM+-1%TK50 RESISTOR	RL 082.7862	DRALORIC	SMA0207/1M-F-D	
R67	RL 0,60W 1MOHM+-1%TK50 RESISTOR	RL 082.7862	DRALORIC	SMA0207/1M-F-D	
R68	RL 0,60W 221 KOHM+-1%TK50 RESISTOR	RL 083.2270	DRALORIC	SMA0207/221K-F-C	
R69	RL 0,60W 1MOHM+-1%TK50 RESISTOR	RL 082.7862	DRALORIC	SMA0207/1M-F-D	
R70	RL 0,60W 4,75KOHM+-1%TK50 RESISTOR	RL 083.1097	DRALORIC	SMA0207/4,75K-F-D	
R71	RL 0,60W 4,75KOHM+-1%TK50 RESISTOR	RL 083.1097	DRALORIC	SMA0207/4,75K-F-D	
R72	RL 0,60W 100KOHM+-1%TK50 RESISTOR	RL 082.1764	DRALORIC	SMA0207/100K-F-C	
R73	RL 0,60W 100KOHM+-1%TK50 RESISTOR	RL 082.1764	DRALORIC	SMA0207/100K-F-C	
R74	RL 0,60W 1MOHM+-1%TK50 RESISTOR	RL 082.7862	DRALORIC	SMA0207/1M-F-D	
R76	RL 0,60W 10,0KOHM+-1%TK50 RESISTOR	RL 083.1297	DRALORIC	SMA0207/10K-F-D	
R77	RL 0,60W 4,75KOHM+-1%TK50 RESISTOR	RL 083.1097	DRALORIC	SMA0207/4,75K-F-D	
R78	RL 0,60W 5,62KOHM+-1%TK50 RESISTOR	RL 082.2190	DRALORIC	SMA0207/5,62K-F-C	
R79	RL 0,60W 182 KOHM+-1%TK50 RESISTOR	RL 083.2193	DRALORIC	SMA0207/182K-F-C	
R80	RL 0,60W 475 KOHM+-1%TK50 RESISTOR	RL 083.2593	DRALORIC	SMA0207/475K-F-C	
R81	RL 0,35W 330 KOHM+-1%TK50 RESISTOR	RL 082.7856	DRALORIC	SMA0207/330K-F-D	
R82	RL 0,60W 22,1KOHM+-1%TK50 RESISTOR	RL 083.1545	DRALORIC	SMA/207/22,1K-F-C	
R83	RL 0,60W 100 OHM+-1%TK50 RESISTOR	RL 082.6543	DRALORIC	SMA0207/100/HM-F-D	
R85	RL 0,60W 2,21KOHM+-1%TK50 RESISTOR	RL 082.2477	DRALORIC	SMA 0207/2,21K-F-C	
R92	RL 0,60W 1KOHM+-1%TK50 RESISTOR	RL 082.2160	DRALORIC	SMA0207/1K-F-C	
R93	RL 0,60W 1,0 OHM+-1%TK50 METALFILMRESISTOR	RL 099.7860	RESISTA	MK2 1,00 OHM 1% TK50	
R94	RL 0,60W 47,5 OHM+-1%TK50 RESISTOR	RL 082.9507	DRALORIC	SMA0207/47,5OHM-F-D	
R96	RL 0,60W 56,2 OHM+-1%TK50 RESISTOR	RL 082.9571	DRALORIC	SMA0207/56,2OHM-F-D	
R97	RL 0,60W 56,2 OHM+-1%TK50 RESISTOR	RL 082.9571	DRALORIC	SMA0207/56,2OHM-F-D	
R98	RL 0,60W 1KOHM+-1%TK50 RESISTOR	RL 082.2160	DRALORIC	SMA0207/1K-F-C	
R99	RL 0,60W 5,62KOHM+-1%TK50 RESISTOR	RL 082.2190	DRALORIC	SMA0207/5,62K-F-C	
R100	RL 0,60W 56,2 OHM+-1%TK50 RESISTOR	RL 082.9571	DRALORIC	SMA0207/56,2OHM-F-D	
R102	RL 0,60W 1,0 OHM+-1%TK50 METALFILMRESISTOR	RL 099.7860	RESISTA	MK2 1,00 OHM 1% TK50	
R103	RL 0,60W 47,5 OHM+-1%TK50 RESISTOR	RL 082.9507	DRALORIC	SMA0207/47,5OHM-F-D	
R104	RL 0,60W 56,2 OHM+-1%TK50 RESISTOR	RL 082.9571	DRALORIC	SMA0207/56,2OHM-F-D	
R105	RL 0,60W 1KOHM+-1%TK50 RESISTOR	RL 082.2160	DRALORIC	SMA0207/1K-F-C	
R106	RL 0,60W 100KOHM+-1%TK50 RESISTOR	RL 082.1764	DRALORIC	SMA0207/100K-F-C	
R107	RL 0,60W 4,32KOHM+-1%TK50 RESISTOR	RL 082.6572	DRALORIC	SMA0207/4,32K-F-D	
R108	RL 0,60W 4,75KOHM+-1%TK50 RESISTOR	RL 083.1097	DRALORIC	SMA0207/4,75K-F-D	
R113	RL 0,60W 10,0KOHM+-1%TK50 RESISTOR	RL 083.1297	DRALORIC	SMA0207/10K-F-D	
R114	RL 0,60W 1KOHM+-1%TK50 RESISTOR	RL 082.2160	DRALORIC	SMA0207/1K-F-C	
R115	RL 0,60W 10,0KOHM+-1%TK50 RESISTOR	RL 083.1297	DRALORIC	SMA0207/10K-F-D	
R116	RL 0,60W 10,0KOHM+-1%TK50 RESISTOR	RL 083.1297	DRALORIC	SMA0207/10K-F-D	

ROHDE & SCHWARZ

Äl Datum
Date

32 1092

Schaltteilliste für
Parts list for

EE AUDIOPLATTE
AUDIO BOARD

Sachnummer
Stock No.

649.4192.01 SA

Blatt
Page

5+

Kennz. Comp.No.	Benennung Designation	Sachnummer Stock No.	Hersteller Manufacturer	Bezeichnung Designation	enthalten in contained in
R117	RL 0,60W 10,0KOHM+-1%TK50 RESISTOR	RL 083.1297	DRALORIC	SMA0207/10K-F-D	
R118	RL 0,60W 10,0KOHM+-1%TK50 RESISTOR	RL 083.1297	DRALORIC	SMA0207/10K-F-D	
R130	RL 0,60W 100 OHM+-1%TK50 RESISTOR	RL 082.6543	DRALORIC	SMA0207/100/HM-F-D	
R131	RL 0,60W 10,0KOHM+-1%TK50 RESISTOR	RL 083.1297	DRALORIC	SMA0207/10K-F-D	
R132	RL 0,60W 2,21KOHM+-1%TK50 RESISTOR	RL 082.2477	DRALORIC	SMA 0207/2,21K-F-C	
R133	RL 0,60W 2,21KOHM+-1%TK50 RESISTOR	RL 082.2477	DRALORIC	SMA 0207/2,21K-F-C	
R137	RL 0,60W 100 OHM+-1%TK50 RESISTOR	RL 082.6543	DRALORIC	SMA0207/100/HM-F-D	
R138	RL 0,60W 68,1 OHM+-1%TK50 RESISTOR	RL 082.9636	DRALORIC	SMA0207/68,10HM-F-D	
R139	RL 0,60W 10,0KOHM+-1%TK50 RESISTOR	RL 083.1297	DRALORIC	SMA0207/10K-F-D	
R140	RL 0,60W 6,81KOHM+-1%TK50 RESISTOR	RL 082.2560	DRALORIC	SMA 0207/6,81K-F-C	
R141	RL 0,60W 274 OHM+-1%TK50 RESISTOR	RL 083.0178	DRALORIC	SMA0207/2740HM-F-D	
R142	RL 0,60W 274 OHM+-1%TK50 RESISTOR	RL 083.0178	DRALORIC	SMA0207/2740HM-F-D	
R143	RL 0,60W 1KOHM+-1%TK50 RESISTOR	RL 082.2160	DRALORIC	SMA0207/1K-F-C	
R144	RL 0,60W 15,0KOHM+-1%TK50 RESISTOR	RL 083.1400	DRALORIC	SMA0207/15K-F-D	
R145	RL 0,60W 150 OHM+-1%TK50 RESISTOR	RL 082.9942	DRALORIC	SMA0207/1500HM-F-D	
R146	RL 0,60W 3,92KOHM+-1%TK50 RESISTOR	RL 083.1039	RESISTA	MK2	
R150	RL 0,60W 6,81KOHM+-1%TK50 RESISTOR	RL 082.2560	DRALORIC	SMA 0207/6,81K-F-C	
R151	RL 0,60W 274 OHM+-1%TK50 RESISTOR	RL 083.0178	DRALORIC	SMA0207/2740HM-F-D	
R152	RL 0,60W 274 OHM+-1%TK50 RESISTOR	RL 083.0178	DRALORIC	SMA0207/2740HM-F-D	
R153	RL 0,60W 1KOHM+-1%TK50 RESISTOR	RL 082.2160	DRALORIC	SMA0207/1K-F-C	
R154	RL 0,60W 10,0KOHM+-1%TK50 RESISTOR	RL 083.1297	DRALORIC	SMA0207/10K-F-D	
R155	RL 0,60W 10,0KOHM+-1%TK50 RESISTOR	RL 083.1297	DRALORIC	SMA0207/10K-F-D	
R156	RL 0,60W 10,0KOHM+-1%TK50 RESISTOR	RL 083.1297	DRALORIC	SMA0207/10K-F-D	
R157	RL 0,60W 68,1KOHM+-1%TK50 RESISTOR	RL 082.2602	DRALORIC	SMA 0207/68,1K-F-C	
R158	RL 0,60W 3,32KOHM+-1%TK50 RESISTOR	RL 083.0990	DRALORIC	SMA0207/3,32K-F-D	
R159	RL 0,60W 274 OHM+-1%TK50 RESISTOR	RL 083.0178	DRALORIC	SMA0207/2740HM-F-D	
R160	RL 0,60W 274 OHM+-1%TK50 RESISTOR	RL 083.0178	DRALORIC	SMA0207/2740HM-F-D	
R161	RL 0,60W 150 OHM+-1%TK50 RESISTOR	RL 082.9942	DRALORIC	SMA0207/1500HM-F-D	
R162	RL 0,60W 332 OHM+-1%TK50 RESISTOR	RL 083.0255	DRALORIC	SMA0207/3320HM-F-D	
R163	RL 0,60W 2,21KOHM+-1%TK50 RESISTOR	RL 082.2477	DRALORIC	SMA 0207/2,21K-F-C	
R164	RL 0,60W 332 OHM+-1%TK50 RESISTOR	RL 083.0255	DRALORIC	SMA0207/3320HM-F-D	
R165	RL 0,60W 121 OHM+-1%TK50 RESISTOR	RL 082.9859	DRALORIC	SMA0207/1210HM-F-D	
R166	RL 0,60W 22,1KOHM+-1%TK50 RESISTOR	RL 083.1545	DRALORIC	SMA/207/22,1K-F-C	
R167	RL 0,60W 121 OHM+-1%TK50 RESISTOR	RL 082.9859	DRALORIC	SMA0207/1210HM-F-D	
R168	RL 0,60W 2,43KOHM+-1%TK50 RESISTOR	RL 083.0884	DRALORIC	SMA0207/2,43K-F-D	
R169	RL 0,60W 2,43KOHM+-1%TK50 RESISTOR	RL 083.0884	DRALORIC	SMA0207/2,43K-F-D	
R170	RL 0,60W 100 OHM+-1%TK50 RESISTOR	RL 082.6543	DRALORIC	SMA0207/100/HM-F-D	
R176	RL 0,60W 10,0KOHM+-1%TK50 RESISTOR	RL 083.1297	DRALORIC	SMA0207/10K-F-D	
R177	RL 0,60W 10,0KOHM+-1%TK50 RESISTOR	RL 083.1297	DRALORIC	SMA0207/10K-F-D	

ROHDE & SCHWARZ	ÄI	Datum Date	Schaltteilliste für Parts list for	Sachnummer Stock No.	Blatt Page
	32	1092			

Für diese Unterlage behalten wir uns alle Rechte vor

Kennz. Comp.No.	Benennung Designation	Sachnummer Stock No.	Hersteller Manufacturer	Bezeichnung Designation	enthalten in contained in
R179	RL 0,60W 100 OHM+-1%TK50 RESISTOR	RL 082.6543	DRALORIC	SMA0207/100/HM-F-D	
R180	RL 0,60W 47,5 OHM+-1%TK50 RESISTOR	RL 082.9507	DRALORIC	SMA0207/47,5OHM-F-D	
R186	RL 0,60W 22,1KOHM+-1%TK50 RESISTOR	RL 083.1545	DRALORIC	SMA/207/22,1K-F-C	
R187	RL 0,60W 33,2KOHM+-1%TK50 RESISTOR	RL 083.1674	DRALORIC	SMA0207/33,2K-F-C	
R188	RL 0,60W15 OHM+-1%TK50 RESISTOR	RL 082.9020	DRALORIC	SMA0207/15OHM-F-D	
R189	RL 0,60W 2,21KOHM+-1%TK50 RESISTOR	RL 082.2477	DRALORIC	SMA 0207/2,21K-F-C	
R190	RL 0,60W 2,21KOHM+-1%TK50 RESISTOR	RL 082.2477	DRALORIC	SMA 0207/2,21K-F-C	
R191	RL 0,60W15 OHM+-1%TK50 RESISTOR	RL 082.9020	DRALORIC	SMA0207/15OHM-F-D	
R192	RF 0,25W 22 OHM +-5% RESISTOR	069.2202	DRALORIC	LCA0207/+-5%22	
R480	RL 0,60W 10,0KOHM+-1%TK50 RESISTOR	RL 083.1297	DRALORIC	SMA0207/10K-F-D	
R620	RL 0,60W 10,0KOHM+-1%TK50 RESISTOR	RL 083.1297	DRALORIC	SMA0207/10K-F-D	
T1	LU UEBERTRAGER TRANSFORMER	649.4463			
U1	BP PC849 4XOPTOCOUPLER OPTO COUPLER	BP 216.1803	SHARP	PC849	
V1	AD 1N4151 50V OA2 UDI DIODE	AD 012.0723	AEG-TELEF.	1N4151	
V2	AD 1N4151 50V OA2 UDI DIODE	AD 012.0723	AEG-TELEF.	1N4151	
V4	AM 2N4856J N-D 40V JFET FET	453.1705	PHILIPS-CO	2N4856JAN/R&S-LV	
V5	AD 1N4151 50V OA2 UDI DIODE	AD 012.0723	AEG-TELEF.	1N4151	
V6	AE BZX79/B5V6 0,5W ZDI ZENER DIODE	AE 012.5254	PHILIPS-CO	BZX79/B5V6	
V8	AD 1N4151 50V OA2 UDI DIODE	AD 012.0723	AEG-TELEF.	1N4151	
V9	AD 1N4151 50V OA2 UDI DIODE	AD 012.0723	AEG-TELEF.	1N4151	
V10	AD 1N4151 50V OA2 UDI DIODE	AD 012.0723	AEG-TELEF.	1N4151	
V11	AD 1N4151 50V OA2 UDI DIODE	AD 012.0723	AEG-TELEF.	1N4151	
V12	AE BV86/1V4 STABISTOR ZENER DIODE	AE 086.9176	PHILIPS-CO	BZX75/C1V4	
V13	AK BCY79IX P 45V 200MA TRANSISTOR	AK 010.3777	PHILIPS-CO	BCY79IX	
V17	AD 1N4151 50V OA2 UDI DIODE	AD 012.0723	AEG-TELEF.	1N4151	
V18	AE 5082-2800 SCHOTTKY DIODE	AE 012.9066	HEWLETT-P.	5082-2800	
V19	AE 5082-2800 SCHOTTKY DIODE	AE 012.9066	HEWLETT-P.	5082-2800	
V20	AD 1N4151 50V OA2 UDI DIODE	AD 012.0723	AEG-TELEF.	1N4151	
V21	AD 1N4151 50V OA2 UDI DIODE	AD 012.0723	AEG-TELEF.	1N4151	
V22	AK BCY59IX N 45V 200MA TRANSISTOR	AK 010.5163	PHILIPS-CO	BCY59IX	
V23	AE BZX79/B6V8 0,5W ZDI ZENER DIODE	AE 586.9906	PHILIPS-CO	BZX79/B6V8	
V24	AE BZX79/B6V8 0,5W ZDI ZENER DIODE	AE 586.9906	PHILIPS-CO	BZX79/B6V8	
V32	AE BZX79/B5V6 0,5W ZDI ZENER DIODE	AE 012.5254	PHILIPS-CO	BZX79/B5V6	
V33	AE BZX79/B5V6 0,5W ZDI ZENER DIODE	AE 012.5254	PHILIPS-CO	BZX79/B5V6	
V34	AG 1N5616JAN GL 400V 1A0 RECTIFIER	491.4843	SEMTECH CO	1N5616JAN(-TX)	
V35	AD 1N4151 50V OA2 UDI DIODE	AD 012.0723	AEG-TELEF.	1N4151	
V36	AD 1N4151 50V OA2 UDI DIODE	AD 012.0723	AEG-TELEF.	1N4151	

ROHDE & SCHWARZ	Äl	Datum Date	Schaltteilliste für Parts list for	Sachnummer Stock No.	Blatt Page
	32	1092	EE AUDIOPLATTE AUDIO BOARD	649.4192.01 SA	7+

Kennz. Comp.No.	Benennung Designation	Sachnummer Stock No.	Hersteller Manufacturer	Bezeichnung Designation	enthalten in contained in
V37	AD 1N4151 50V OA2 UDI DIODE	AD 012.0723	AEG-TELEF.	1N4151	
V130	AD 1N4151 50V OA2 UDI DIODE	AD 012.0723	AEG-TELEF.	1N4151	
V131	AE BZX79/B5V6 0,5W ZDI ZENER DIODE	AE 012.5254	PHILIPS-CO	BZX79/B5V6	
V132	AK BCY79IX P 45V 200MA TRANSISTOR	AK 010.3777	PHILIPS-CO	BCY79IX	
V133	ZM TRANSISTOR	649.4486			
V134	ZM TRANSISTOR	649.4492			
V135	AE BZX79B33 2% 0.5W ZDI ZENER	AE 008.7640	PHILIPS	BZX79B33	
V136	AE BZX79B33 2% 0.5W ZDI ZENER	AE 008.7640	PHILIPS	BZX79B33	
V137	AD 1N4151 50V OA2 UDI DIODE	AD 012.0723	AEG-TELEF.	1N4151	
V138	AE BZX79/B5V6 0,5W ZDI ZENER DIODE	AE 012.5254	PHILIPS-CO	BZX79/B5V6	
V139	AK BCY59IX N 45V 200MA TRANSISTOR	AK 010.5163	PHILIPS-CO	BCY59IX	
V140	AK BCY59IX N 45V 200MA TRANSISTOR	AK 010.5163	PHILIPS-CO	BCY59IX	
V146	AG B80C700 80V OA8 BRGL RECTIFIER	AG 092.9345	SIEMENS	A 0512	
V147	AD 1N4151 50V OA2 UDI DIODE	AD 012.0723	AEG-TELEF.	1N4151	
V148	AE 1N4690 5V6 0.3W ZDI ZENER DIODE	AE 303.9124	SEMITRONIC	1N4690	
V149	AK BCY79IX P 45V 200MA TRANSISTOR	AK 010.3777	PHILIPS-CO	BCY79IX	
V150	ZM TRANSISTOR	649.4492			
V151	AD 1N4151 50V OA2 UDI DIODE	AD 012.0723	AEG-TELEF.	1N4151	
V152	AE BZV86/1V4 STABISTOR ZENER DIODE	AE 086.9176	PHILIPS-CO	BZX75/C1V4	
V153	AK BCY59IX N 45V 200MA TRANSISTOR	AK 010.5163	PHILIPS-CO	BCY59IX	
V154	AK BCY59IX N 45V 200MA TRANSISTOR	AK 010.5163	PHILIPS-CO	BCY59IX	
V155	AD 1N4151 50V OA2 UDI DIODE	AD 012.0723	AEG-TELEF.	1N4151	
V156	AK BCY59IX N 45V 200MA TRANSISTOR	AK 010.5163	PHILIPS-CO	BCY59IX	
V163	AD 1N4151 50V OA2 UDI DIODE	AD 012.0723	AEG-TELEF.	1N4151	
V164	AD 1N4151 50V OA2 UDI DIODE	AD 012.0723	AEG-TELEF.	1N4151	
V165	AG 1N5617JAN GL 400V 1A0 RECTIFIER	439.6161	UNITRODE C	1N5617JAN(-TX)	
V166	AM IRFF120 N-E 100V MOSF POWER MOSFET	660.5210	INTERNAT.R	IRFF120	
V167	AM IRFF120 N-E 100V MOSF POWER MOSFET	660.5210	INTERNAT.R	IRFF120	
V168	AD 1N4151 50V OA2 UDI DIODE	AD 012.0723	AEG-TELEF.	1N4151	
V169	AD 1N4151 50V OA2 UDI DIODE	AD 012.0723	AEG-TELEF.	1N4151	
V170	AD 1N4151 50V OA2 UDI DIODE	AD 012.0723	AEG-TELEF.	1N4151	
V171	AD 1N4151 50V OA2 UDI DIODE	AD 012.0723	AEG-TELEF.	1N4151	
X2 ..5	FP STIFTLISTE 36P.R2,54 PIN CONNECTOR 7X3-POLIG	FP 242.3600	BINDER	742-11-0179-00-36	
X21	FP KURZSCHLUSSBUCHSE SHORTING PLUG	FP 491.7042	PK	452-70302	
X22	FP KURZSCHLUSSBUCHSE SHORTING PLUG	FP 491.7042	PK	452-70302	
X31	FP KURZSCHLUSSBUCHSE SHORTING PLUG	FP 491.7042	PK	452-70302	
X32	FP KURZSCHLUSSBUCHSE SHORTING PLUG	FP 491.7042	PK	452-70302	
X41	FP KURZSCHLUSSBUCHSE SHORTING PLUG	FP 491.7042	PK	452-70302	

ROHDE & SCHWARZ	Äl	Datum	Schaltteilliste für Parts list for	Sachnummer Stock No.	Blatt Page
		Date			
	32	1092	EE AUDIOPLATTE AUDIO BOARD	649.4192.01 SA	8+

Für diese Unterlage behalten wir
uns alle Rechte vor

Kennz. Comp.No.	Benennung Designation	Sachnummer Stock No.	Hersteller Manufacturer	Bezeichnung Designation	enthalten in contained in	
X42	FP KURZSCHLUSSBUCHSE SHORTING PLUG	FP 491.7042	PK	452-70302	- ENDE -	
X51	FP STECKERLEISTE 64POLIG 64-PIN INSERT	FP 084.6470	THOMAS&BET	161-66430-3008		
Z1 .6	LD 5MHZ/20DB 10A CHOKE	LD 453.4404	OXLEY	DBZ4/P/22000		
ROHDE & SCHWARZ		Äl	Datum Date	Schaltteilliste für Parts list for	Sachnummer Stock No.	Blatt Page
		32	1092	EE AUDIOPLATTE AUDIO BOARD	649.4192.01 SA	9-



ROHDE & SCHWARZ

ÄZ Datum
Date

03 0484

Schaltteilliste für
Parts list for
ED MOTHERBOARD

Sachnummer
Stock No.

649.4211.01 SA

Blatt
Page

1

Kennzeichen Component No.	Benennung/Beschreibung Designation	Sachnummer Stock No.	enthalten in contained in
.	VARIANTENERKL. / VERSIONS VAR 02 = GRUNDAUSFUEHRUNG MOD 02 = BASIC MODEL		
..	ZUGEH. STROML. / CIRC. DIAGR. 649.4011 S		
T1	LU NF-UEBERTR. 0,5+0,5:1 TRANSFORMER HAUFE R&S-ZCHNG. 586.7932	586.7932	
X21	FP STECKERL. INDIR. 64POLIG 64-PIN INSERT ERNI STV-P-264 9722.333.	FP 084.6470	
X31	FP STECKERLEISTE 10POL. CONNECTOR 10POL. PANDUIT 050-010-1333BC	FP 649.4428	
X41	FP IND. BUCHSENLEISTE 64P. FEMALE MULTIPOINT CONNECT ERNI 9722.343.481.2	FP 278.1913	
X51	FP IND. BUCHSENLEISTE 64P. FEMALE MULTIPOINT CONNECT ERNI 9722.343.481.2	FP 278.1913	
X61	FP BUCHSENLEISTE 50POL. CONNECTOR 50P. PANDUIT 050A-050-435A	FP 099.9463	649.4270
			- ENDE -

Für diese Unterlage behalten wir
uns alle Rechte vor

Kennz. Comp.No.	Benennung Designation	Sachnummer Stock No.	Hersteller Manufacturer	Bezeichnung Designation	enthalten in contained in
	VARIANTENERKL. / VERSIONS VAR 02 = GRUNDAUSFUEHRUNG MOD 02 = BASIC MODEL				
A20	ED BELEUCHTUNGSEINHEIT LED PANEL	649.5699.02			
C1	CC 100NF+-10%50V5K1200VIE CAPACITOR	CC 084.5350	UNION CARB	CK05BX104K	
C2	CC 100NF+-10%50V5K1200VIE CAPACITOR	CC 084.5350	UNION CARB	CK05BX104K	
..6					
C8	CC 100NF+-10%50V5K1200VIE CAPACITOR	CC 084.5350	UNION CARB	CK05BX104K	
C10	CC 10NF+-10%100V5K1200VIE CERAMIC CAPACITOR	CC 068.4060	UNION CARB	CK05BX103K	
C20	CC 4,7NF+-10%6X9R2000 CAPACITOR	CC 087.7102	VALVO	2222 63051 472	
..34					
D1	BL CD4030BE 4X2IN.EXORG EXOR GATE	086.7173	RCA	CD4030BE	
D2	BL CD4047BE MULTIVIBR. MULTIVIBRATOR	349.2980	RCA	CD4047BE	
D3	BL CD4054BE 4S.LCD DRIV LCD DRIVER	303.9053	RCA	CD4054BE	
D5	BL CD4514BE 1-OF-16 DEC DECODER	299.6589	RCA	CD4514BE	
D10	BL CD4056BE 7S.LCD DRIV LCD DRIVER	086.7267	RCA	CD4056BE	
..18					
D19	BL CD4054BE 4S.LCD DRIV LCD DRIVER	303.9053	RCA	CD4054BE	
D20	BL CD4054BE 4S.LCD DRIV LCD DRIVER	303.9053	RCA	CD4054BE	
D21	BL CD4054BE 4S.LCD DRIV LCD DRIVER	303.9053	RCA	CD4054BE	
D22	BL CD4054BE 4S.LCD DRIV LCD DRIVER	303.9053	RCA	CD4054BE	
D23	BL CD4054BE 4S.LCD DRIV LCD DRIVER	303.9053	RCA	CD4054BE	
H1	AF HLMP3301 LED RT RD5 LED	092.8710	HEWLETT PA	HLMP3301	
H2	AF HLMP3401 LED GE RD5 LED	092.8703	HEWLETT	HLMP3401	
P1	BP LCD 9X 7SEGM.13MM TFL LC-DISPLAY	645.8364	VARITRONIX	R&S-ZCHNG.645.8364-B	
R1	RL 0,35W 68,1 OHM+-1%TK50 RESISTOR	RL 082.9636	DRALORIC	SMA0207/68,10HM-F-D	
..5					
R10	RL 0,35W 221 OHM+-1%TK50 RESISTOR	RL 083.0084	DRALORIC	SMA0207/2210HM-F-D	
R11	RL 0,35W 10.0KOHM+-1%TK50 RESISTOR	RL 083.1297	DRALORIC	SMA0207/10K-F-D	
R12	RL 0,35W 100KOHM+-1%TK50 RESISTOR	RL 082.1764	DRALORIC	SMA0207/100K-F-C	
R13	RL 0,35W 4,75KOHM+-1%TK50 RESISTOR	RL 083.1097	DRALORIC	SMA0207/4,75K-F-D	
R14	RL 0,35W 221 OHM+-1%TK50 RESISTOR	RL 083.0084	DRALORIC	SMA0207/2210HM-F-D	
R22	RL 0,35W 10,0KOHM+-1%TK50 RESISTOR	RL 083.1297	DRALORIC	SMA0207/10K-F-D	
R23	RL 0,35W 10,0KOHM+-1%TK50 RESISTOR	RL 083.1297	DRALORIC	SMA0207/10K-F-D	
R24	RL 0,35W 18,2KOHM+-1%TK50 RESISTOR	RL 083.1480	DRALORIC	SMA/207/18,2K-F-C	
S2	SD 1EBENE 1MAL 4 KURZSCHL ROTARY SWITCH	SD 645.8164	ITT	N.K-BL. SD 2131/2133	
S3	SD 1EBENE 1MAL 3 UNTERBR. ROTARY SWITCH	SD 645.8187	ITT	N. K-BL. SD2131/2133	
S4	SD 2EBENEN 2MAL 5 KURZSCH ROTARY SWITCH	SD 645.8170	ITT	N. K-BL. SD2131/2133	
V3	AK BCY79IX P 45V 200MA TRANSISTOR	AK 010.3777	VALVO	BCY79IX	
V4	AK BCY59IX N 45V 200MA TRANSISTOR	AK 010.5163	VALVO	BCY59IX	
		Äl Datum	Schaltteilliste für		Sachnummer
		Date	Parts list for		Stock No.
ROHDE & SCHWARZ		04 0490	ED ANZEIGEPLATTE DISPLAY PANEL		649.5676.01 SA
					1+

Kennz. Comp.No.	Benennung Designation	Sachnummer Stock No.	Hersteller Manufacturer	Bezeichnung Designation	enthalten in contained in
V5	AK BCY79IX P 45V 200MA TRANSISTOR	AK 010.3777	VALVO	BCY79IX	
X11	FR IC-FASSUNG 16 POLIG 16-PIN IC-SOCKET	FR 249.6091	PRECICONT	US016T	
X21	FP BUCHSENLEISTE 64POL. FEMALE MULTIPOINT CONNECT	FP 278.1913	PANDUIT	100-064-433/999	
X23	MF BUCHSE	649.5301			
X22A	FP STIFTL.WIN 36P.R2,54 ANGLE PIN CONNECTOR 5-POLIG	FP 243.3578	BINDER	742-5-11-0187-00-36	
X22B	FP STIFTL.WIN 36P.R2,54 ANGLE PIN CONNECTOR 5-POLIG	FP 087.9105	BINDER	742-5-11-0191-00-36	
					- ENDE -

ROHDE & SCHWARZ	Äl	Datum Date	Schaltteilliste für Parts list for	Sachnummer Stock No.	Blatt Page
	04	0490	ED ANZEIGEPLATTE DISPLAY PANEL	649.5676.01 SA	2-

**ROHDE & SCHWARZ**

ÄZ	Datum
02	0285

 Schaltteilliste für
 Parts list for
ED BELEUCHTUNGSEINHEIT
LED PANEL

Sachnummer	Stock No.
649.5699.01	SA

Blatt	Page
1	1

Kennzeichen Component No.	Benennung/Beschreibung Designation	Sachnummer Stock No.	enthalten in contained in
.	ZUGEH. STROML. / CIRC. DIAGR. 649.5676 S		
..	VARIANTENERKL. / VERSIONS VAR 02 = GRUNDAUSFUEHRUNG MOD 02 = BASIC MODEL		
H12	AF HLMP3401 LED 6E RD5 LED HEWLETT-P. HLMP-3401	AF 092.8703	649.5718
BIS/TO H21			
X23	FP INDIREKT. STECKERL. 36P. PIN CONNECTOR BERG 75160-102-36 6-POLIG	FP 242.3600	
			- ENDE -



ROHDE & SCHWARZ

Communications Division

Repair Manual

FSK MODEM

GM 852P2

646.4710

©

Copying of this document as well as any other utilization and communication of its content are only admissible with the permission of the originator or other authorized persons.

Any disregard will be prosecuted and is subject to restitution (UrhG, UWG, BGB). For the case a patent is issued or the design is officially registered all rights are reserved.

ROHDE & SCHWARZ GmbH & Co. KG · D-81671 München · Mühldorfstr. 15 · Tel. (089) 4129-0 Int. + 4989 4129-0

Telefax (089) 4129-2164 Int. + 4989 4129-2164

**Printed in the Federal Republic of Germany · Subject to change · Data without tolerances : order of magnitude only
0694**

List of Contents

1. Characteristics
2. Preparation for Use
3. Operation
4. Maintenance and Troubleshooting

Note: These chapters are contained in the user manual of the relevant transceiver.

5. Description of Function

	Page
5.1 Reception	5.1
5.1.1 Conditioning of Oscillator Frequency	5.1
5.1.2 Active Mixer	5.1
5.1.3 Phase-locked Loop and Multiplication of Shift	5.2
5.1.4 Quadrature Mixer Stage and V.28 Interface	5.2
5.1.5 Output Soft Decision	5.3
5.2 Transmission	5.3
5.2.1 Conditioning of 26.666-kHz Reference Signal	5.4
5.2.2 Phase-locked Loop with Frequency Divider	5.4
5.3 Voltage Stabilization	5.5
5.4 Test Operation	5.5
5.5 Data Input	5.5

6. Repair

	Page
6.1	Preliminary Remarks 6.1
6.1.1	General 6.1
6.1.2	Restoring Nominal Characteristics 6.1
6.1.3	Alignment 6.1
6.1.4	Spare Parts 6.1
6.1.5	Important User Information 6.2
6.2	Test Equipment and Special Tools 6.3
6.2.1	List of Test Equipment 6.3
6.3	Troubleshooting 6.4
6.3.1	General 6.4
6.4	Measurements, Alignment and Functional Checks 6.10
6.4.1	V.28 Output 6.10
6.4.2	Switchover of Polarity for FSK Reception 6.10
6.4.3	Check of Transmitting Function 6.10
6.4.4	Check of Inputs TTY Mod. Local and TTY Mod. Remote 6.11
6.4.5	Setting of FSK Modulator 6.11
6.4.6	Check of FSK Test Function 6.11
6.4.7	Check of TTY-Stop Function 6.11
6.5	Replacement of Components 6.12

FSK MODEM • GM 852P2

Repair Manual

	Page
6.6	Final Test 6.12
6.6.1	Test of Current Consumption 6.12
6.6.2	Test of IF Alignment 6.12
6.6.3	Test of Control Voltage on 13.2-MHz Oscillator 6.12
6.6.4	Test of Sensitivity 6.12
6.6.5	Test of Shift Direction 6.13
6.6.6	Test of Analog Output Shift 6.13
6.6.7	Check of Modulator Control Voltage 6.13
6.6.8	Test of Carrier Switch-off 6.13
6.6.9	Check of Transmission Shift Switchover 6.13
6.6.10	Test of Polarity of Modulator 6.15
6.6.11	Test of Oscillator Suppression 6.15
6.6.12	Check of Sideband Suppression 6.15
6.7	External Interfaces 6.15

FSK MODEM • GM 852P2

Repair Manual

List of Figures

Fig.	Title	Page
5.1	Control Commands	5.4
5.2	Frequency Plan of FSK Modem GM 852P2	5.7
5.3	FSK Modem GM 852P2, Block Diagram	5.9
6.1	Troubleshooting Flowchart	6.5

Appendix

Interface Description, Circuit Diagram, Parts Lists and Components Layout

Interface Description	A.1
Circuit Diagram	646.4710.01S
Parts List	646.4710.01SA
Parts List	646.4727.01SA
Components Layout	646.4727.01, sheets 2 and 3

5. Description of Function

See Circuit Diagram 646.4710.01S, Block Diagram, Fig. 5.3 and Frequency Plan, Fig. 5.2.

5.1 Reception

An FSK signal received at the frequency of 1.44 MHz is fed via connector X32 to the FSK modem and then converted in the demodulator into a logic teleprinter signal. The frequency shift of the FSK signal can assume a value of ± 425 Hz, ± 85 Hz or ± 42.5 Hz.

The 1.44-MHz FSK signal is mixed to an intermediate frequency of 26.666 kHz in an active mixer and then filtered by a bandpass filter. Then a frequency conversion to a mean frequency of 13.2 MHz is achieved via a controllable 13.2-MHz oscillator, which is integrated in a phase-locked loop. Thus the shift of the FSK signal is multiplied by a factor of 495.

The multiplied 13.2-MHz FSK signal is divided by 2 and therefore assumes a frequency value of 6.6 MHz + 247.5 \times shift. In a logic quadrature mixer stage this signal is mixed down to a virtual mean frequency of 0 and converted into a logic teleprinter signal.

5.1.1 Conditioning of Oscillator Frequency

The crystal-stabilized 79.2-MHz oscillator signal from Synthesizer GF 852P1 or GF 852H2, thereafter used as reference signal, is fed to connector X33 with a level of approx. 0 dBm. In the following transistor circuit the oscillator signal is then converted to TTL level and fed to the multi-stage divider circuit D200 to D202, which produces a sum frequency division of 54:1.

The two flipflops D200 are configured as a 3:1 divider and flipflop D201 as a 2:1 divider. Divider D202 has a division ratio of 9:1. The divided oscillator signal (1.4666 MHz) is fed by the 9:1 divider D202.12 to the oscillator input of mixer U201 with a level of approx. 0.5 V_{pp}.

Two antiphase signals with a duty factor of 1:1 at a frequency of 13.2 MHz are tapped at the two flipflop outputs D201.5 and D201.6. In flipflop D5 each of these signals is divided by 2. Thus two 6.6-MHz signals are available at outputs D5.5 and D5.9. The two signals are 90° out of phase. Each of these signals is used as an oscillation signal in the quadrature mixer stage.

5.1.2 Active Mixer

The signal from the FSK Modem GM 852P2 has a mean frequency of 1.44 MHz with a level of approx. 0 dBm. It is fed via connector X32, HF choke L203 and coupling capacitor C203 to the mixer terminal U201.1. Here it is mixed with the 1.466-MHz reference signal.

The low frequency product of the previous mixing in U201.1 with a value of 26.666 kHz + shift is filtered out by means of the bandpass filter located between R1 and N2.6. The mean frequency of the bandpass filter may be set by means of potentiometers R12 and R14. Following operational amplifier N3.7 the signal is converted to TTL level in a level converter and from there it is forwarded to phase bridge D1.14.

Operational amplifier N3 works without feedback. The circuit functions as a comparator without hysteresis. Operational amplifiers N104, N103, N4 and N5 are also made up of this kind of circuitry.

Transistor V2 in the level converter is configured with an anti-saturation diode in the base-collector path to improve the switching response.

FSK MODEM • GM 852P2

Repair Manual • Description of Function

5.1.3 Phase-locked Loop and Multiplication of Shift

The phase-locked loop (PLL) consists of the following components:

1. Switchable active low-pass filter (circuit between R18 and R23);
2. 13.2-MHz oscillator which can be aligned by means of diodes V5 to V8;
3. Comparator N4;
4. Level converter with transistor V3;
5. Divider circuit D4, D3 and D2 with a divider ratio of 495:1 and
6. Phase bridge D1.

The switchable low-pass filter in the feedback path of the phase-locked loop is switched by means of the processor via switch N10 such that optimal band limiting is achieved according to the applied shift. For this purpose, RC combination R74 and C75 is cut in for a small shift, R78 and C76 for a medium shift and R79 for a large shift.

Notations 0, 1, 2 given on switches N10 for the control commands is equivalent to H0, H1 and H2. The relationship between shift and TTL level of the control commands can be seen in Fig. 5.1.

The mean frequency of the 13.2-MHz oscillator is mainly determined by L5 and C28. The momentary oscillation frequency is fed back to the basis of transistor V10 via resistor R37 and capacitor C28. By means of high-pass filter C25 / R32 the control signal is separated from the oscillation frequency. To the output of comparator N7.4 the oscillation frequency is applied as a 1:1 pulse sequence.

The FSK signal is fed to phase bridge D1 via input D1.14 with a value of 26.666 kHz + shift. Via input D1.3 the phase bridge is supplied with a signal from the 13.2-MHz oscillator which was previously divided by 495. Via output D1.13 of the phase bridge the oscillator frequency is modulated such that the frequency on input D1.3 of the phase bridge assumes the same value as the frequency applied to input D1.14.

In case the frequency of the FSK signal jumps over from the low to the high cut-off frequency, the frequency of the 13.2-MHz oscillator is continuously adapted via the loop filter un-

til its value is 495 times greater than the 26.666-kHz FSK frequency.

Thus the FSK signal is frequency modulated to 13.2 MHz + 495 x shift (= 495 x (26.666 kHz + shift)). The multiplication of the shift permits accurate evaluation of the frequency shift.

5.1.4 Quadrature Mixer Stage and V.28 Interface

The shift-multiplied and frequency-modulated 13.2-MHz FSK signal is fed to comparator N5 via low-pass filter C34 / R43. There it is converted to TTL level. The frequency of the TTL signal is divided by 2 in flipflop D6.3.

This signal is then fed to the two terminals D6.12 and D7.12 of the quadrature mixer stage. There the 6.6-MHz FSK signals are in each case mixed down to 0 by means of the 6.6-MHz reference signals at a phase shift of 90°.

The quadrature mixer stage consists of flipflops D6 (D6.3 to D6.5 excluded), D7 and D13 as well as AND gate D14.

Output D7.6 supplies information about the direction of the shift. Flipflop D13 is driven by the 6.6-MHz reference signals to obtain a defined phase relation for the reference signals when the supply voltage is switched on. After passing AND gate D14.6 the FSK signal is demodulated.

At this point the signal is separated. One part of the teleprinter signal is fed to connector X31.a8 for the evaluation of the Soft Decision. The other part of the teleprinter signal is conditioned for the V.28 interface via an active low-pass filter (circuit between R55 and R58) and a Schmitt trigger (circuit between R58 and R65).

Operational amplifier N8, resistor R88 and capacitors C57 and C77 together form a switchable active low-pass filter. The switchover is achieved by means of connector X201. When jumper X202 is placed on contacts 2 and 3, signal filtering is optimized for velocities of the teleprinter lower than 100 bauds. At higher velocities of the teleprinter the jumper is placed on contacts 1 and 2 (parking position).

FSK MODEM • GM 852P2

Repair Manual • Description of Function

Via input E0 recording of the teleprinter signal is inhibited during transmission when jumper X102 is placed on contacts 2 and 3 of connector X101. In case the jumper is in the parking position (on contacts 1 and 2), the transmitted signal is recorded.

Schmitt trigger output N9.1 controls the interface driver. Driver output N9.7 is applied to contact X31.b5 (V.28 output) via low-pass filter R69 / C68 and choke L11. V34 is a switching transistor which switches off the driver via input TS when the signal is noisy or missing.

V26 functions as a switching transistor controlling the polarity of the teleprinter signal via input P. V28 and V30 are protective diodes protecting driver N9 when data are fed back into contact X31.b5.

5.1.5 Output Soft Decision

In the quadrature mixer stage the product of mixing with a value of $|247.5 \times \text{shift}|$ is fed out of mixer output D6.9 for the Soft Decision. In integrated components D8 and D9 the frequency is then converted to a constant value of $247.5 \times 85 \text{ Hz}$. Thus, independent of the frequency shift, information about the unintended frequency deviation is available. For this purpose the sum value of the mixed product is divided by 5 at a shift of $\pm 425 \text{ Hz}$ and by 1 at a shift of $\pm 85 \text{ Hz}$ while it is multiplied by 2 at a shift of $\pm 42.5 \text{ Hz}$. The division ratios are set by logic signals H2, *H2 and H0.

This means in detail: For a shift of $\pm 42.5 \text{ Hz}$ the division ratio of D8 is 1:1. D9 is alternately triggered by inputs D9.5 and D9.4 thus switching on the doubler circuit in D9. For a shift of $\pm 85 \text{ Hz}$ the division ratio of D8 is 1:1. Command H0 switches off the doubler circuit in D9. For a shift of $\pm 425 \text{ Hz}$ the division ratio of D8 is switched to 5:1; the doubler circuit in D9 remains switched off.

After this frequency conversion a frequency-voltage conversion is made. Thus a voltage is available on output D9.6 which is proportional to a deviation from the respective nominal

frequency shift. This voltage is filtered by RC low-pass filter configuration R47/C40 to R45/C38 and then fed to comparator circuit N7.

Comparator N7.14 switches in the lower quarter of the voltage value, N7.1 at half the voltage value and N7.2 at three quarters of the voltage value. Comparator circuit N7 with the following logic circuit functions as an analog / digital converter or as a 1-out-of-3 decoding circuit.

The output signals of the decoding circuit are fed to contacts X31.a6 and .a7 thus reproducing the (unintended) frequency deviation from the set frequency shift in a digital form.

The signals designated as Soft Decision have CMOS levels and can be fed to external devices.

Output D9.6 is fed to amplifier N8 following the low-pass filter configuration. Its output voltage is applied to contact X31.b22. The signal is designated Frequency Shift and reproduces the frequency deviation from the set shift in an analog form.

5.2 Transmission

In transmission a logic teleprinter signal is fed to the modulator. In the modulator this signal is converted to an FSK signal which is symmetric to 1.44 MHz and has a frequency shift of $\pm 42.5 \text{ Hz}$, $\pm 85 \text{ Hz}$ or $\pm 425 \text{ Hz}$. The frequency shift is freely selectable in accordance with the baud rate.

In order to make sure that the FSK signal is produced as a soft and crystal-stabilized signal, the frequency keying is carried out in a phase-locked loop. A tunable 16.6-MHz oscillator and a switchable frequency divider are integrated in the phase-locked loop. By means of the frequency divider the oscillation frequency of the oscillator is converted to a multiple of 26.666 kHz such that an integer is produced. In the following text these multiples will be referred to as N1. The relation of the logic levels high and low of the teleprinter signal and N1 as a function of the shift can be seen in the table, Fig. 5.1.

FSK MODEM • GM 852P2

Repair Manual • Description of Function

5.2.1 Conditioning of 26.666-kHz Reference Signal

A 26.666-kHz reference signal is required for the phase-locked loop. This signal is produced by continued phase-locking division from the crystal-stabilized 79.2-MHz oscillator signal, which is fed to the FSK modem via connector X33. In detail this is done by means of dividers D200 (3:1), D201 (2:1) D202 (9:1), D100 and D101 (55:1).

5.2.2 Phase-locked Loop with Frequency Divider

The phase-locked loop consists of phase bridge D102, a switchable loop filter (circuit between R109 and R117), the 16.6-MHz oscillator, comparator N104 and switchable divider circuit D105 to D103.

The 16.6-MHz oscillator is tunable by means of capacitance diodes V105 to V108 in the range of 16.400 MHz (= 615 x 26.666 kHz) to 16.933 MHz (= 635 x 26.666 kHz). Its mean frequency is mainly determined by capacitor C131 and inductor L103. Via resistor R133 the momentary oscillation frequency is partly fed back to the basis of transistor V104.

The 16.6-MHz oscillator is coupled to comparator N104 via high-pass filter C134 / R135. The output signal of comparator N104.7, previously converted to TTL level, is fed to counter group D103 to D106, which functions as switchable frequency divider.

The switching signals setting the division ratio of the counter group are fed in via AND gate D107 to D108. The relationship between the divider N1 and F, *F and H0 to H2 can be seen in the following table, Fig. 5.1.

The direction of the shift is controlled by F and *F. F is the logic teleprinter signal, which is fed in from contact X31.b7 or X31.b8 as TTY Mod. Local oder TTY Mod. Remote via level converter D206.4.

TTL level			F = H *F = L	F = L *F = H
H0	H1	H2	N1 (shift (Hz))	
H	L	L	626 (+ 42.5)	624 (-42.5)
L	H	L	627 (+ 85)	625 (-85)
L	L	H	635 (+ 425)	615 (-425)

Fig. 5.1 Control Commands

*Control commands for divider circuit:
H = high, L = low, *F = NOT F.
High and low both have TTL levels.*

H0, H1 and H2 control the size of the shift. These signals in turn are fed in via data inputs X31.a11 and X31.a12, memory D207 and level converter D204.

A signal of 16.4 to 16.933 MHz coming from the 16.6-MHz oscillator is fed to input D106.2 of the counter group. This signal is divided in the divider group by N1 and then fed to phase bridge D102.3 via transistor V103.

Phase bridge D102 compares the divided 16.666-MHz signal to the crystal-stabilized 26.666-kHz reference signal at input D102.14. Then the oscillator frequency is adapted via output D102.13 until the divided oscillator frequency also assumes a value of 26.666 kHz and is in phase with the reference signal. The control voltage is applied to the capacitance diodes and thus also to the oscillator via low-pass filter R117 / C111 and choke L102.

Thus if divider N1 abruptly changes in accordance with the teleprinter signal, the 16.666-MHz oscillator follows this change with some delay which is due to the adjustable cut-off frequency of the loop filter.

Optimal adjustment of the cut-off frequency of the loop filter to the respective shift is achieved by means of control commands H0 to H2. The logic values of the control commands as a function of the size of the shift can also be seen in Fig. 5.1. The loop filter is synchronized with the loop filter in the demodulator by means of control commands 0, 1 and 2.

FSK MODEM • GM 852P2

Repair Manual • Description of Function

The FSK signal thus soft-keyed is then decoupled from the control circuit via high-pass filter C123 / R125 and comparator N103.3 and fed to divider circuit D112 to D110 as a TTL signal via input D112.2. The high-pass filter separates the control signal from the oscillator frequency. The entire divider circuit has a division ratio of 625:1. Divider D112 divides by a ratio of 5:1 and dividers D111 and D110 divide by a ratio of 125:1.

The signal previously divided by N1 x 26.666 kHz to 26.666 kHz + shift is then filtered by means of the circuit between D110.12 and N102.6. The input level of the low-pass filter R123 / C117 is set by means of potentiometer R124. The remaining part of the circuit forms an active low-pass filter. Via coupling capacitor C222 the filtered (26.666 kHz + shift) FSK signal is fed to mixer U200.1 and converted to the new carrier frequency of 1.44 MHz by means of the 1.466-MHz reference signal.

The 1.44-MHz product of this mixing is filtered by means of the LC bandpass filter consisting of capacitors C210 to C213 and inductors L200 and L201 and amplified to 0 dBm by transistor V200. Then the FSK signal is fed to connector X32. The suppression of the 1.466-MHz line at the output of the mixer can be set by means of potentiometer R218. HF choke L203 reduces interference voltages.

From connector X32 the (1.44 MHz + shift) FSK signal is fed to FSK Modem GM 852P2 and converted to the transmit frequency in the following transmission path.

At the branching point between the two capacitors C214 and C203 one part of the transmit signal is coupled into the demodulator. This signal is routed through the reception path until it arrives at the V.28 interface.

5.3 Voltage Stabilization

To improve interference suppression the 15-V supply voltages are provided with voltage regulators. Fixed-voltage regulator N202 produces the voltage of +12 V. Voltage regulator N203 with transistors V216 and V217 generates the voltage of -12 V. At the -12-V output the stabilized voltage of -7 V is generated via Zener diode V212. In the F1 mode relay RS1 is energized; and contact RS1 switches through the supply voltage of 5 V.

5.4 Test Operation

During test operation Processor GS 851P1 sends a pulse sequence with TTL levels to input X31.a4. Thus the divider in the divider circuit D103 to D106 in the modulator is switched over and the 16.6-MHz oscillator is therefore frequency-modulated.

This frequency-modulated signal is applied to the input of the demodulator via output mixer U200 and coupling capacitor C203. The signal is routed through the modulator to output N9.1 of the operational amplifier. There the demodulated signal is applied to contact X31.a5.

In the Processor GS 852P1 or GS 852H2 the demodulated test signal is compared to the transmitted test signal. If the values of both signals are alike, the tested reception / transmission loop is in correct condition.

After completion of the test operation, the processor switches the HF transceiver back to the previously set operating mode.

For the avoidance of any interference in the test operation, FET switch N201 (3, 4) switches amplifier output N200.2 to ground potential.

5.5 Data Input

The FSK Modem GM 852P2 is driven by Processor GS 852P1 or GS 852H2 via connector X31, contacts .a9, .b9 and .b12. Via contact X31.a18 the modulator of the FSK modem is enabled.

Via contacts X31.a11 and .a12 the data for setting the shift are fed in. Contact X31.a14 is used for the TTY STOP command and X31.a15 for the test command. X31.a12 additionally serves for local / remote switchover.

By way of contact X31.a13 the polarity of the transmit signal is switched over on operational amplifier N200.2 and that of the receive signal on operational amplifier N9.7.

The F1 mode is set via contact X31.b11.

The input data are fed to D flipflops D207, D208 and D210 and stored there. The conversion of data from the 5-V logic to the 12-V logic is made in level converters D204 to D206. The outputs control the associated AND gates, transistor switches, FET switches and amplifiers.

6. Repair

See circuit diagram, parts list and components layout in the appendix to this repair manual (list on page 0.4).

6.1 Preliminary Remarks

6.1.1 General

The repair of the FSK Modem GM 852P2 consists of troubleshooting and fault elimination, of measurements, alignment and functional checks, of replacing assemblies and components as well as of a final test.

All the information required for repairing the FSK modem down to component level is given in this chapter 6.

Any fault that occurs should be localized with the aid of the troubleshooting flowchart given in 6.1.

6.1.2 Restoring Nominal Characteristics

Any component that is definitely proved to be defective - through use of the troubleshooting flowchart or by performing the alignment, measurements and functional checks - should only be replaced by a component that meets the specifications given in the parts list in the appendix to this repair manual.

Only in this way can the technical data be guaranteed that are given in section 1 of the user manual.

Once components have been replaced, it is absolutely essential that the final test of the FSK modem be performed as detailed in chapter 6.6.

6.1.3 Alignment

After manufacture and before submission to the test department, the components of this FSK modem were artificially aged according to specification XVN016.

This offers high stability of its values once they have been set. If, during repair, components are used that have not been aged, one must expect a certain drift in individual values. For this reason it is advisable to carry out an occasional alignment according to 6.4 or an occasional check acc. to 6.6 (final test).

6.1.4 Spare Parts

All components and assemblies are subjected to strict quality control before they are incorporated in the FSK Modem GM 852P2.

For components from outside suppliers, e.g. resistors, capacitors, diodes, transistors and integrated through to highly integrated circuits, R&S have set down their own delivery specifications for the purpose of ensuring maximum reliability. For this reason we recommend that only original spare parts be used to replace defective components.

When ordering a spare part, please state the following:

type, ordering code and serial number of equipment, identification number of the parts list and designation plus stock number of the component concerned.

All of these details are to be found in the circuit diagram, parts list and components layout attached to this manual.

FSK MODEM • GM 852P2

Repair Manual • Important User Information

6.1.5 Important User Information

Please note the following points, which are important for the avoidance of misunderstandings when using part 6 of this repair manual:

- Abbreviations in the text, such as X31.a7 and B2.5 are to be understood as follows:

Connector 31 - contact a7

Component 2 - contact 5

- All components mentioned in the following text are to be found in circuit diagram 646.4710S. Thus this circuit diagram will not be mentioned specially.
- All alignment and measurements have to be carried out with the operating voltages given in the circuit diagram.
- All voltage measurements are referred to ground, if not stated otherwise.
- All HF measurements on the FSK modem have to be performed with the covers screwed down in place; if necessary, a special test cover has to be produced for this purpose.
- Make sure that cables and connections have the correct characteristic impedance for HF measurements and that the connecting leads are as short as possible.
- Before carrying out any soldering on the module or any component, make sure the supply voltages are disconnected.

CAUTION ESD

Among the components incorporated in the FSK Modem GM 852P2 there are electrostatic sensitive devices (ESD), MOS, MOSFET and CMOS devices.

Devices of this kind are extremely sensitive to high extraneous voltages. Static discharge can produce very high voltage spikes, which are capable of destroying these devices.

For this reason, when work is being carried out in the vicinity of these devices, i.e. unless a special CMOS work station is available, the following minimum requirements should be observed:

- conductive bench and floor coverings,
- chair or stool with conductive coverings,
- grounded, metallic work surface and conductive wrist-straps with a resistance of $> 200 \text{ k}\Omega$, $< 1 \text{ M}\Omega$ plus an insulated lead and plug,
- soldering irons with safety grounding,
- all conductive surfaces, wrist-straps and work surfaces must be interconnected by insulated leads.

FSK MODEM • GM 852P2

Repair Manual • Test Equipment

6.2 Test Equipment and Special Tools

The test equipment given in the following list will be required for performing the repairs described in this part of the manual. Equivalent items of test equipment can be used. Special tools are not required.

6.2.1 List of Test Equipment

Item no.	Test equipment, required data	Test equipment recommended by R&S	Ordering code
1	Mobile Tester	SMFP 2	332.0015.53
2	Digital Multimeter	UDL 45	1037.1507.02
3	Generator 1.44 MHz, external triggering, 1 Hz resolution, FM modulation	SMK	348.0010.03
4	Frequency counter 5 MHz, sensitivity 10 mV, resolution 1 Hz (contained in item no. 1)		
5	Spectrum Analyzer, frequency range 0.1 to 100 MHz, sensitivity > -80 dBm, level-indication range 80 dB	FSA	804.8010.52
6	Dual-channel oscilloscope, 60 MHz	Conventional workshop model	
7	RF Test Receiver	ESH 2	303.2020.05
8	Service Kit	KA 852 C1	648.8513.02

FSK MODEM • GM 852P2
Repair Manual • Troubleshooting

6.3 Troubleshooting

6.3.1 General

The following troubleshooting flowchart (Fig. 6.1) comprises troubleshooting as well as the elimination of faults in the FSK Modem GM 852P2.

To make the troubleshooting flowchart clearer and more understandable, cross-references to

other measurements and repair work are given where necessary.

To enable the troubleshooting and elimination of faults to be carried out as rationally and speedily as possible, the order of the tests should be followed as presented here.

FSK MODEM • GM 852P2
Repair Manual • Troubleshooting

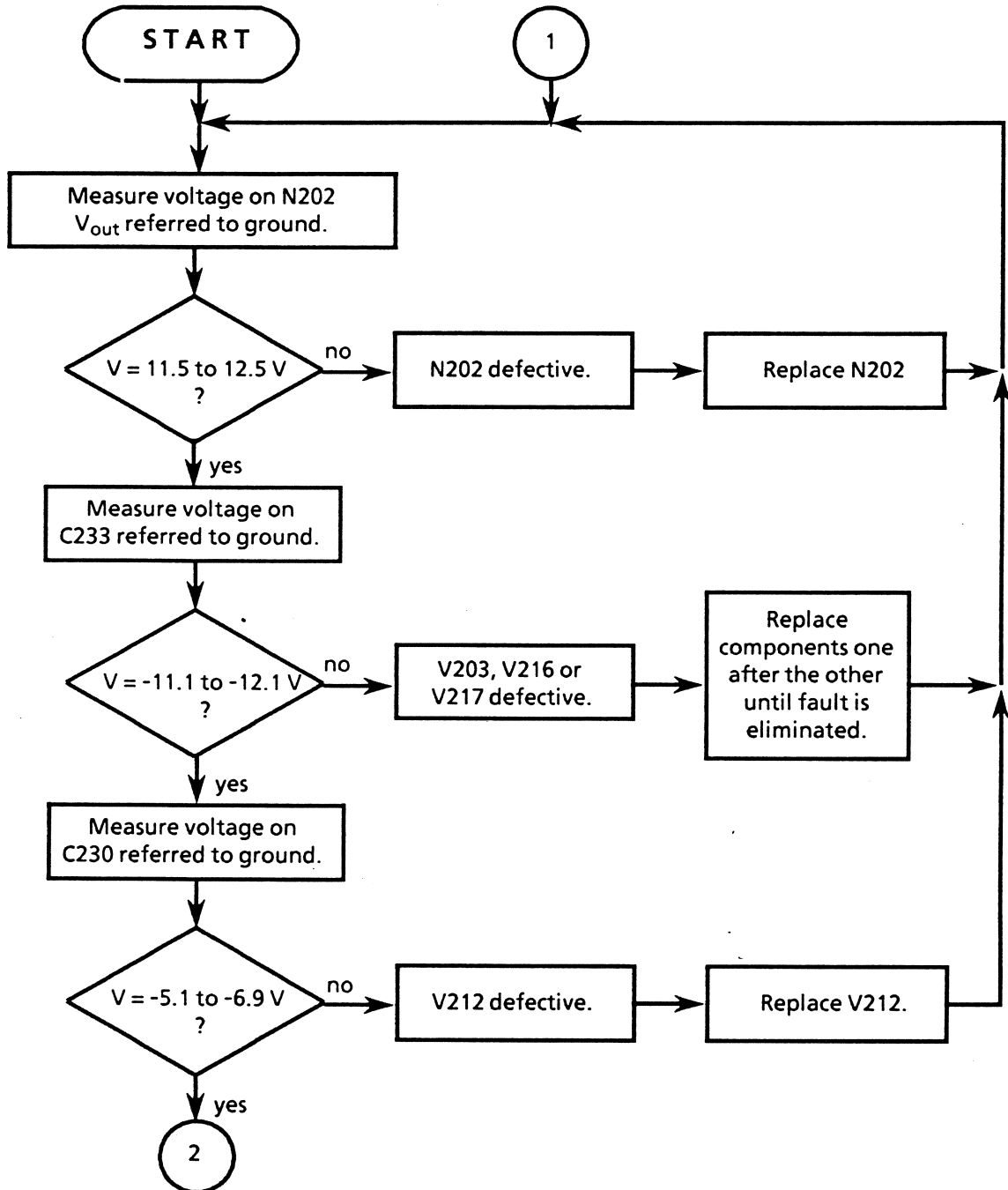

Fig. 6.1 Troubleshooting Flowchart (page 1 of 5)

673.5237.62.01

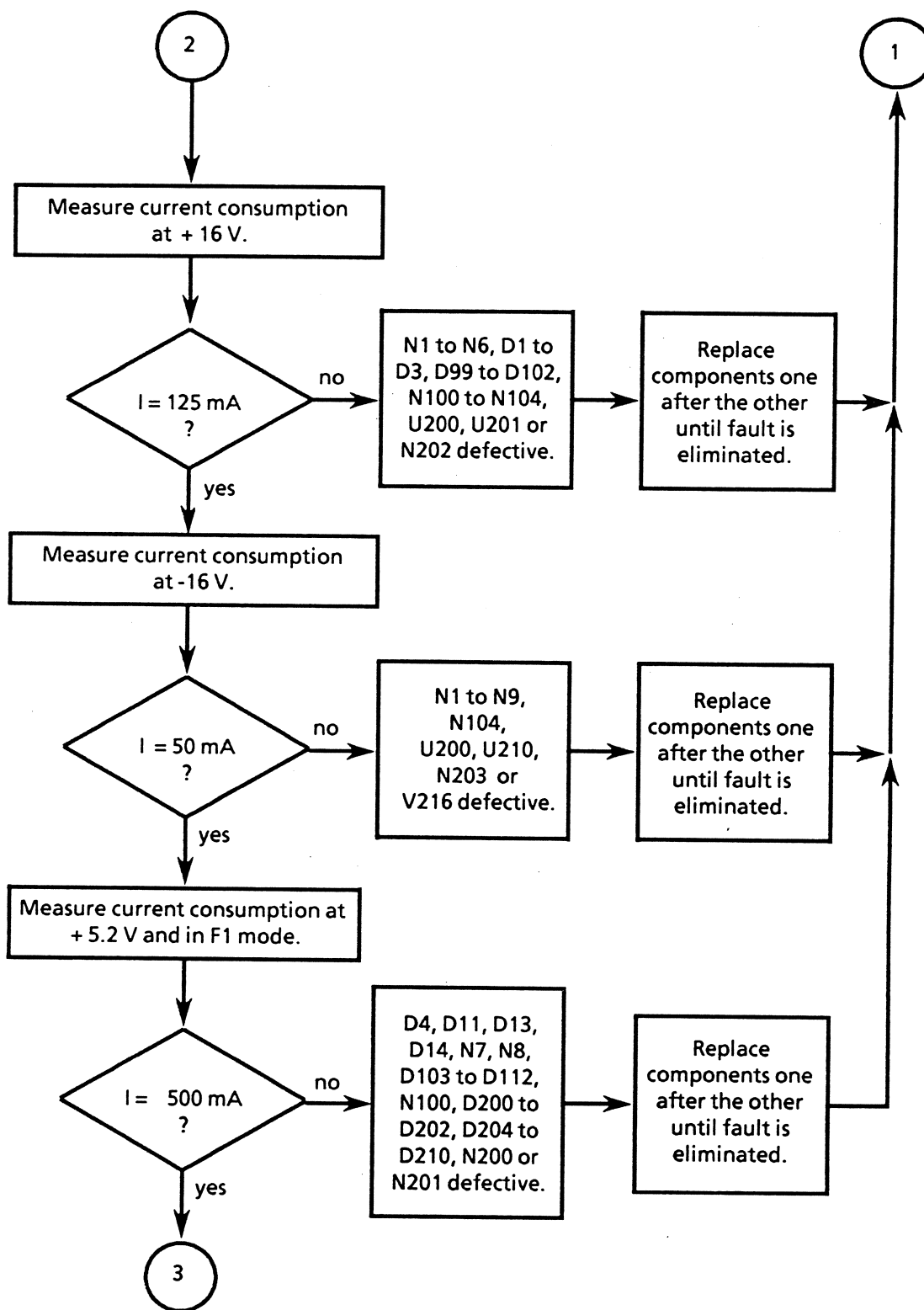

Fig. 6.1 Troubleshooting Flowchart (page 2 of 5)

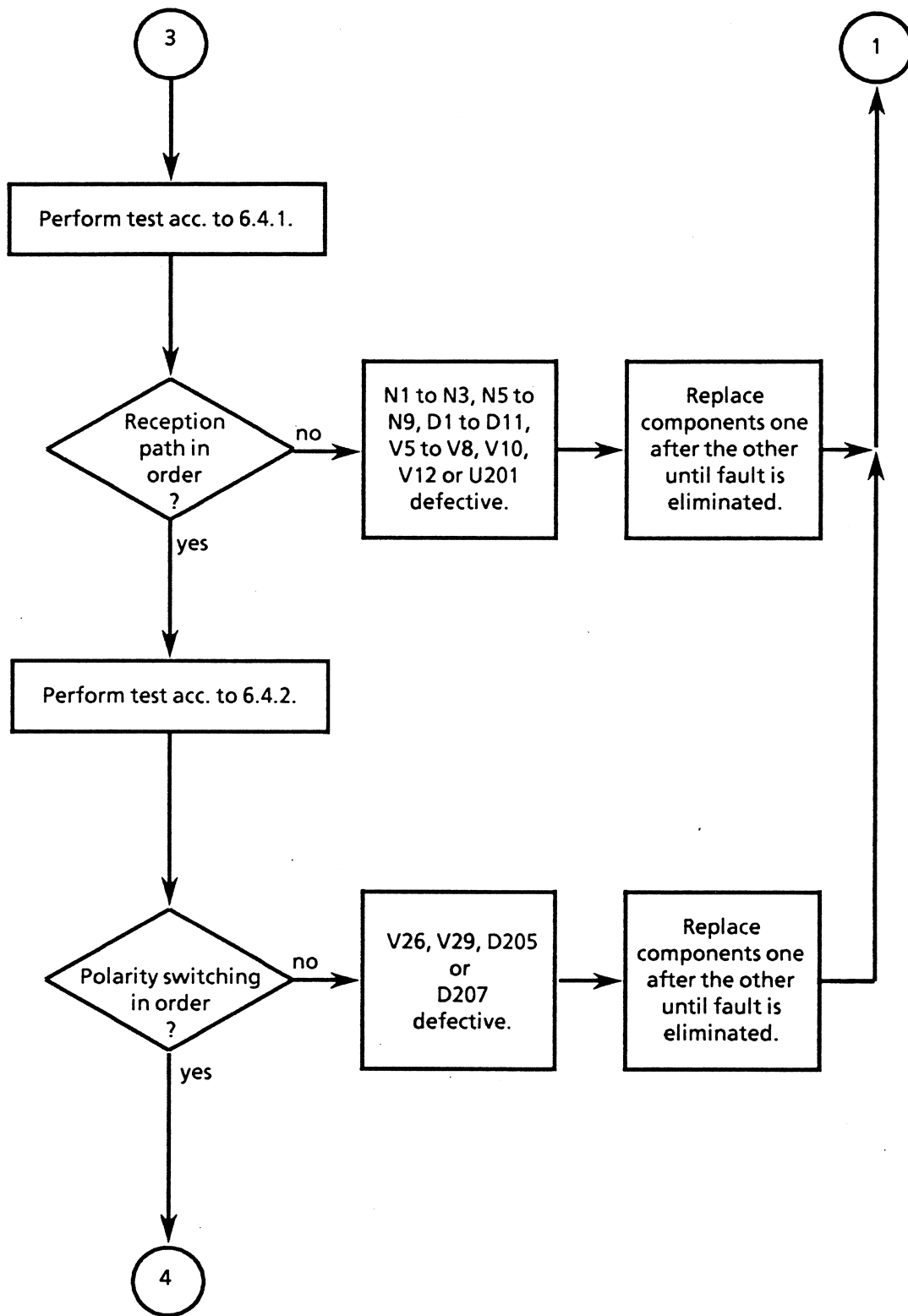

Fig. 6.1 Troubleshooting Flowchart (page 3 of 5)

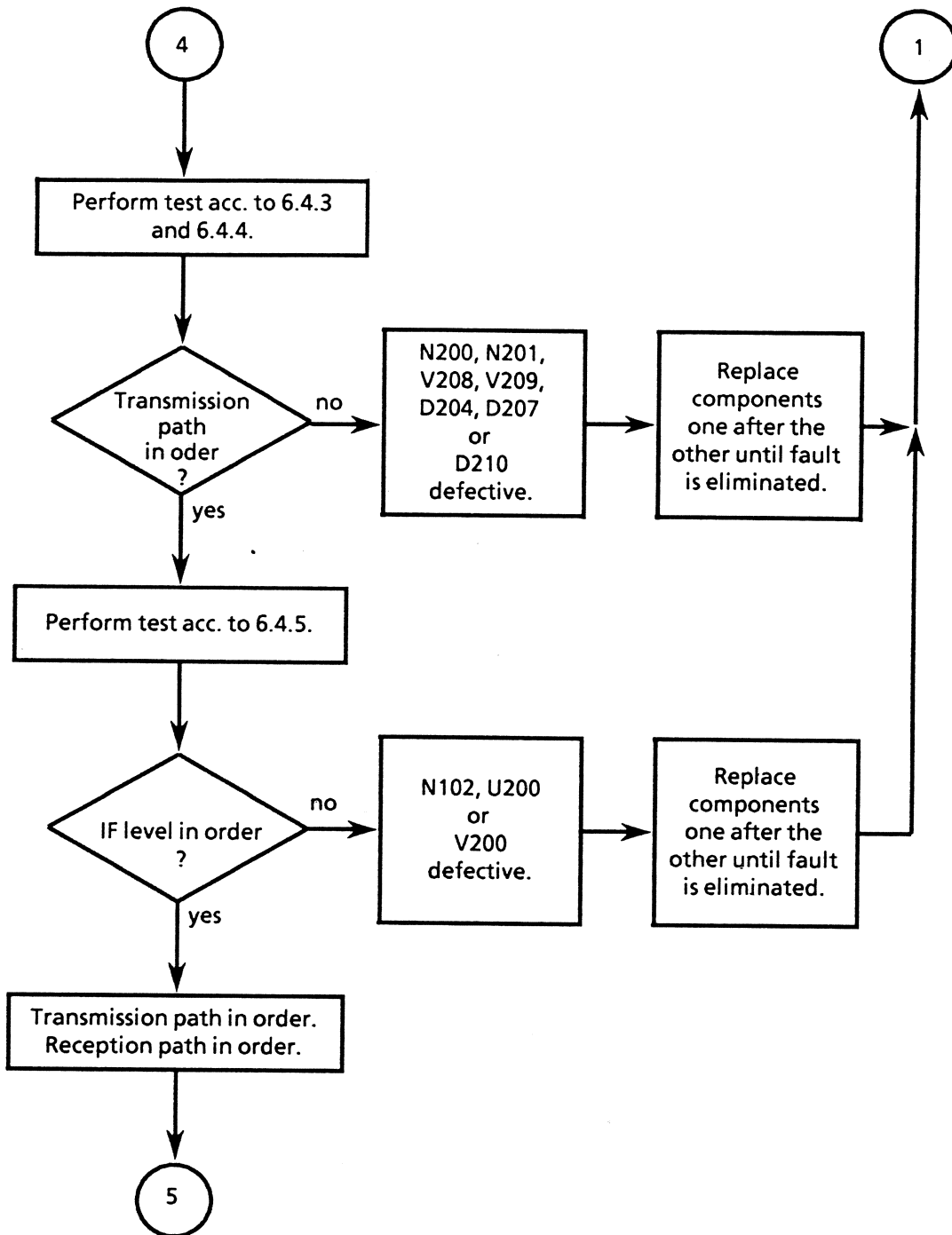

Fig. 6.1 Troubleshooting Flowchart (page 4 of 5)

673.5237.62.01

FSK MODEM • GM 852P2
Repair Manual • Troubleshooting

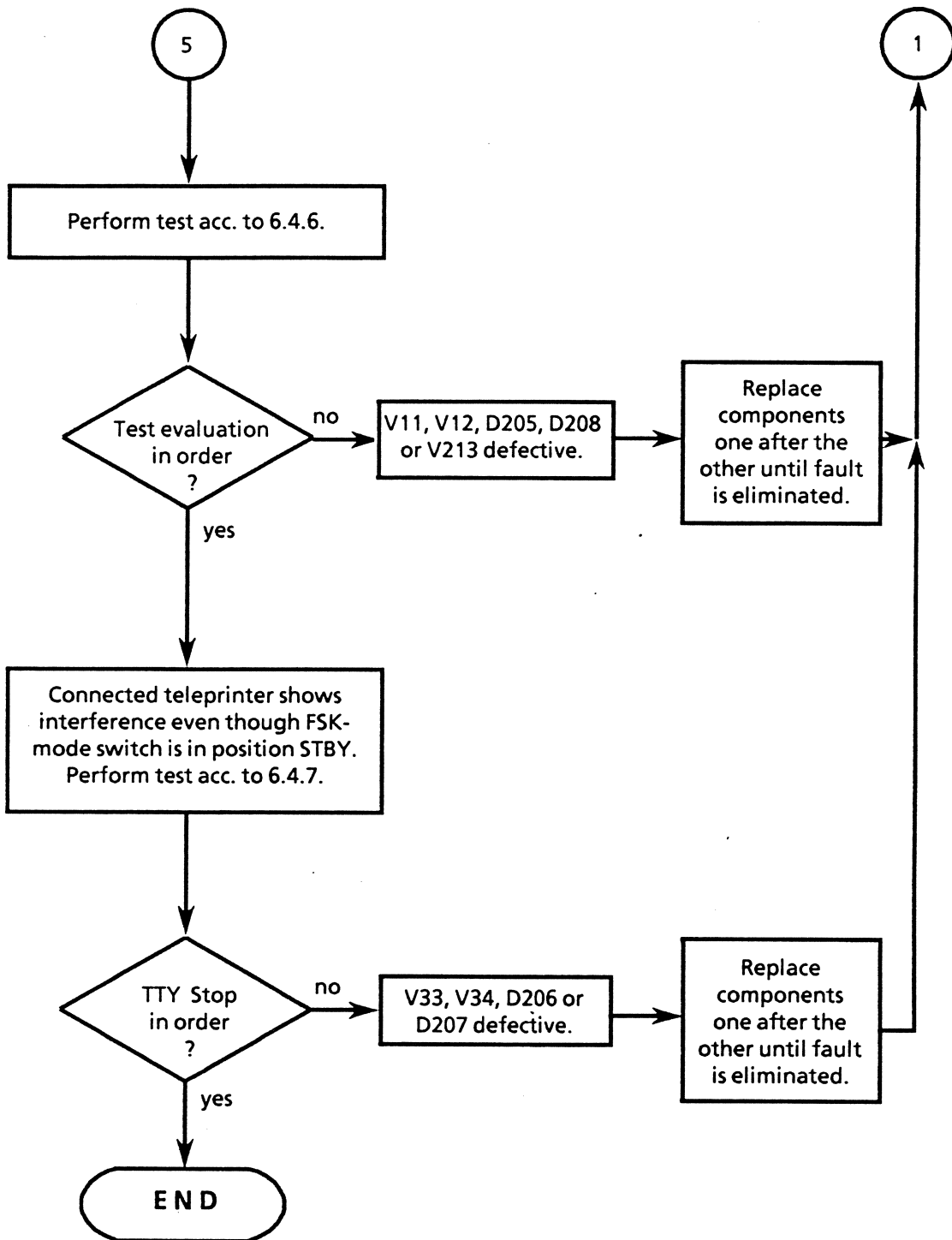

Fig. 6.1 Troubleshooting Flowchart (page 5 of 5)

673.5237.62.01

FSK MODEM • GM 852P2

Repair Manual • Measurements, Alignment and Functional Checks

6.4 Measurements, Alignment and Functional Checks

The measurements, alignment and functional checks described below are the more detailed procedures to the instructions given in condensed form in the troubleshooting flowchart. Consequently the measurements, alignment and functional checks are usually undertaken by branching out of the troubleshooting flowchart at a particular point. When the measurement etc. has been performed, return to the troubleshooting flowchart and continue at the same point where it has been left.

If a fault has been clearly identified beforehand however, one can of course commence with one of these measurements, etc. directly.

For all measurements or tests it is assumed that the FSK Modem GM 852P2 and the interface unit from the service kit are connected to the REMOTE socket on the rear of the HF transceiver. Open the FSK modem according to 6.5.

6.4.1 V.28 Output

1. Set the operation mode switch on the control unit to Rx.
2. Set the FSK switch on the control unit to Rx and press FSK¹ key.
3. On connector X32 feed in an HF signal of 1.440010 MHz with -6 dBm.

Measure output voltage on contact X31.b5 (V.28 output) using a digital multimeter.

Nominal value of output voltage:

$$-10.2 \pm 1.2 \text{ V}$$

4. Reduce the frequency to 1.439990 MHz with -6 dBm.

Nominal value of output voltage:

$$+ 10.2 \pm 1.2 \text{ V}$$

5. Set the HF signal to 1.44 MHz with -6 dBm, 100 Hz FM-modulated and 1-kHz shift.

Measure the pulse duty factor on contact X31.b5 using an oscilloscope.

Nominal value of the pulse duty factor:
1:1

6. If required, set the pulse duty factor by means of R24.

6.4.2 Switchover of Polarity for FSK Reception

1. Set the operation mode switch on the control unit to Rx.
2. Set the FSK switch on the control unit to Rx and press FSK¹ key.
3. On connector X32 feed in an HF signal of 1.440020 MHz with -6 dBm.

Measure output voltage on contact X31.b5.

Nominal value of output voltage with negative polarity (HF LED on the control unit is illuminated):

$$-10.2 \pm 1.2 \text{ V.}$$

4. Change the polarity using the keyboard of the control unit.

Nominal value of output voltage with positive polarity (HF LED on the control unit is illuminated):

$$+ 10.2 \pm 1.2 \text{ V}$$

6.4.3 Check of Transmitting Function

1. Set the operation mode switch on the control unit to Tx.
2. Set the FSK switch on the control unit to Tx and press the FSK¹ key.

FSK MODEM • GM 852P2

Repair Manual • Measurements, Alignment and Functional Checks

3. On connector X32 feed in an HF signal of 1.439990 MHz with -6 dBm.

Measure output voltage on contact X31.b5.

Nominal value of output voltage:

$$-10.2 \pm 1.2 \text{ V}$$

6.4.4 Check of Inputs TTY Mod. Local and TTY Mod. Remote

1. Set the operation mode switch on the control unit to Tx.
2. Set the FSK switch on the control unit to Tx and press the FSK[†] key.
3. Link contact X31.a24 to contact X31.b3 and connector X6 of the interface unit to contact X31.b7.

CAUTION

The connection between contact X31.b7 and the HF transceiver must be separated.

4. Measure output frequency on connector X32 using a frequency counter.

Nominal value of output voltage:

$$1.439575 \text{ MHz} \pm 20 \text{ Hz}$$

6.4.5 Setting of FSK Modulator

1. Set the operation mode switch on the control unit to Tx.
2. Set the FSK switch on the control unit to Tx and press the FSK[†] key.
3. Terminate connector X32 with a wave resistance of 50 Ω .
4. Connect test receiver (1.44 MHz) to connector X32. Link contact X31.b7 to connector X6 of the interface unit.

CAUTION

The connection between contact X31.b7 and the HF transceiver must be separated.

Nominal value of output voltage:

$$0 \text{ dBm} \pm 0.3 \text{ dBm}$$

5. If required, set the output voltage by means of potentiometer R124.

6.4.6 Check of FSK Test Function

1. Set the operation mode switch on the control unit to Rx.
2. Set the FSK switch on the control unit to Rx and press FSK[†] key.
3. Connect channel 1 of the oscilloscope to X31.a4 and channel 2 of the oscilloscope to X31.a5.
4. After starting the test on the control unit, compare channels 1 and 2 of the oscilloscope. The frequencies of the pulses must assume the same values.

6.4.7 Check of TTY-Stop Function

1. Set the operation mode switch on the control unit to Rx.
2. Set the FSK switch on the control unit to STBY and press FSK[†] key.
3. On connector X32 feed in an HF signal of 1.439990 MHz with -6 dBm.
4. Measure voltage on contact X31.b5.

Nominal value of output voltage:

$$-10.2 \pm 1.2 \text{ V}$$

5. Increase the frequency to 1.440010 MHz with -6 dBm.

Nominal value of output voltage:

$$-10.2 \pm 1.2 \text{ V}$$

FSK MODEM • GM 852P2

Repair Manual • Replacement of Components and Final Test

6.5 Replacement of Components

Before replacing any components open the FSK modem as follows:

1. Remove the top HF cover after undoing six Phillips screws.
2. Remove the bottom HF cover after undoing six Phillips screws.

The replacement of components follows usual workshop practice. No special instructions are necessary.

After replacement of components continue troubleshooting according to Fig. 6.1.

6.6 Final Test

After a repair has been carried out, the FSK Modem GM 852P2 must be subjected to the following final test to ensure that its technical data can still be guaranteed.

For this final test the interface unit from the service kit must be connected to the socket REMOTE on the rear of the HF transceiver.

If this final test does not prove satisfactory, the testing and troubleshooting following the troubleshooting flowchart (Fig. 6.1) will have to be repeated. Repeat the procedure as many times as is necessary to detect and eliminate all faults.

6.6.1 Test of Current Consumption

Measure current consumption with the operating voltages connected.

Nominal values:

- + 16 V: ≤ 125 mA
- 16 V: ≤ 50 mA
- + 5.2 V: ≤ 500 mA (F1 on)
 ≤ 5 mA (F1 off)

6.6.2 Test of IF Alignment

1. Set the operation mode switch on the control unit to Rx.
2. Set the FSK switch on the control unit to Rx and press FSK key.
3. On connector X32 feed in an HF signal of 1.44 MHz with -6 dBm.
4. Measure IF voltage on amplifier N3.3 and, if necessary, align to maximum using potentiometers R12 and R14.

Nominal value of 26.666-kHz IF voltage:

$$1 V_{rms} + 0.5 V_{rms}$$

6.6.3 Test of Control Voltage on 13.2-MHz Oscillator

1. Set the operation mode switch on the control unit to Rx.
2. Set the FSK switch on the control unit to Rx and press the FSK key.
3. On connector X32 feed in an HF signal of 1.44 MHz with -6 dBm.
4. Connect a digital voltmeter to point R23 / C20 and measure the control voltage.

Nominal value of control voltage:

$$6 V \pm 1 V$$

6.6.4 Test of Sensitivity

1. Set the operation mode switch on the control unit to Rx.
2. Set the FSK switch on the control unit to Rx and press the FSK key.
3. On connector X32 feed in an HF signal of 1.44 MHz with -30 dBm.
4. Connect an oscilloscope to contact X31.a6 or X31.a7.

FSK MODEM • GM 852P2

Repair Manual • Final Test

5. Reduce the input voltage on connector X32 until pulses appear on test point X31.a6 or X31.a7 instead of a high level.

Nominal value on connector X32:

≤ -35 dBm

3. Measure control voltage on point R117 / C111.

Nominal value of the control voltage:

6 ± 1 V

6.6.5 Test of Shift Direction

1. Set the operation mode switch on the control unit to Rx.
2. Set the FSK switch on the control unit to Rx and press FSK[Ⓜ] key.
3. On connector X32 feed in an HF signal of 1.440005 MHz with -6 dBm. The logic level on contact X31.a8 must be low.
4. On connector X32 reduce the frequency to 1.439995 MHz with -6 dBm. The logic level on contact X31.a8 must be high.

6.6.6 Test of Analog Output Shift

1. Set the operation mode switch on the control unit to Rx.
2. Set the FSK switch on the control unit to Rx and press FSK[Ⓜ] key. On connector X32 feed in an HF signal of 1.440370 MHz with -6 dBm.
3. Measure the output voltage on contact X31.b22.

Nominal value of output voltage:

$+ 3.4 \pm 0.3$ V

6.6.7 Check of Modulator Control Voltage

1. Set the operation mode switch on the control unit to Tx.
2. Set the FSK switch on the control unit to Tx and press FSK[Ⓜ] key.

6.6.8 Test of Carrier Switch-off

1. Set the operation mode switch on the control unit to Rx.
2. Set the FSK switch on the control unit to Rx and press FSK[Ⓜ] key.
3. Link contact X31.b7 to connector X6 of the interface unit.

CAUTION

The connection between contact X31.b7 and the HF transceiver must be separated.

4. Measure output level at 1.4400424 MHz on connector X32 with a termination of 50 Ω using a test receiver.

Nominal value of the output voltage:

≤ -50 dBm

6.6.9 Check of Transmission Shift Switchover

1. Set the operation mode switch on the control unit to Tx.
2. Set the FSK switch on the control unit to Tx and press FSK[Ⓜ] key.
3. Link contact X31.b7 to connector X6 of the interface unit.

CAUTION

The connection between contact X31.b7 and the HF transceiver must be separated.

FSK MODEM • GM 852P2

Repair Manual • Final Test

4. Measure output on connector X32 using frequency counter.

Nominal value of the frequency:

1.4400425 MHz \pm 2 Hz

5. Link contact X31.a24 to X31.b7.

CAUTION

The connection between contact X31.b7 and the HF transceiver must be separated.

6. Measure output on connector X32 using frequency counter.

Nominal value of the frequency:

1.4399575 MHz \pm 2 Hz

7. Switch on medium shift H1 for FSK operation.

8. Link contact X31.b7 to connector X6 of the interface unit.

CAUTION

The connection between contact X31.b7 and the HF transceiver must be separated.

9. Measure output on connector X32 using frequency counter.

Nominal value of the frequency:

1.440085 MHz \pm 4 Hz

10. Link contact X31.a24 to contact X31.b7.

CAUTION

The connection between contact X31.b7 and the HF transceiver must be separated.

11. Measure output on connector X32 using frequency counter.

Nominal value of the frequency:

1.439915 MHz \pm 4 Hz

12. Switch on great shift H2 for FSK operation. Link connector X6 of the interface unit to connector X3.

CAUTION

The connection between contact X31.b3 and the HF transceiver must be separated.

13. Measure output on connector X32 using frequency counter.

Nominal value of the frequency:

1.440425 MHz \pm 20 Hz

14. Link contact X31.a24 to contact X31.b3.

CAUTION

The connection between contact X31.b3 and the HF transceiver must be separated.

15. Measure output on connector X32 using frequency counter.

Nominal value of the frequency:

1.439575 MHz \pm 20 Hz

FSK MODEM • GM 852P2

Repair Manual • Final Test, External Interfaces

6.6.10 Test of Polarity of Modulator

1. Set the operation mode switch on the control unit to Tx.
2. Set the FSK switch on the control unit to Tx and press FSK¹ key.
3. Link connector X6 of the interface unit to connector X3.

CAUTION

The connection between contact X31.b3 and the HF transceiver must be separated.

4. Measure output on connector X32 using frequency counter.

Nominal value of the frequency:

1.439575 MHz \pm 20 Hz

5. The polarity display (-) on the control unit must be illuminated.
6. Press key POL on the control unit.

Nominal value of the output frequency:

1.440425 MHz \pm 20 Hz

7. The polarity display (+) on the control unit must be illuminated.

6.6.11 Test of Oscillator Suppression

1. Set the operation mode and FSK switch on the control unit to Tx and press FSK¹ key.
2. Connect the test receiver (1.466666 MHz) to connector X32. Link connector X6 of the interface unit to connector X3.

CAUTION

The connection between contact X31.b3 and the HF transceiver must be separated.

Nominal value of the oscillator suppression: \leq -15 dB

3. If required, align the level to minimum using potentiometer R128.

6.6.12 Check of Sideband Suppression

1. Set the operation mode switch on the control unit to Tx.
2. Set the FSK switch on the control unit to Tx and press FSK¹ key.
3. Check the sideband between 1.440425 MHz and 1.65 MHz. A spectrum analyzer can also be connected as a test receiver.

Nominal value of sideband suppression:

\leq -15 dB

6.7 External Interfaces

A detailed description of the interfaces of the FSK Modem GM 852P2 is contained in the appendix to this Repair Manual.



ROHDE & SCHWARZ

Communications Division

Appendix

CIRCUIT DIAGRAMS

PARTS LISTS

COMPONENTS LAYOUTS

FSK MODEM • GM 852P2

Repair Manual • Interface Description

A. Interface Description

Contact	Signal Name Description	Direction	Type	Range of Value	Remarks
X31.a1	not used				
X31.a2	not used				
X31.a3	not used				
X31.a4	Test F1 Mod. out	input		high $\geq 3\text{ V}$, low $\leq 2\text{ V}$ $V_{\max} \leq 6\text{ V}$, $V_{\min} \geq -1\text{ V}$ $R_i \geq 50\ \Omega$	switching frequency $\leq 200\text{ Hz}$
X31.a5	Test F1 Mod. in	output		+ 5 V + 0.3 V if X.31.a4 is high; 0 V + 0.2 V if X31.a4 is low	
X31.a6	Soft decision, output A	output		CMOS output	
X31.a7	Soft decision, output B	output		CMOS output	
X31.a8	Soft decision, output C	output		TTL LS	54 LS 00
X31.a9	Strobe 8	input	high	CMOS input	
X31.a10	Data 0	input	high	CMOS input	
X31.a11	Data 1	input	high	CMOS input	
X31.a12	Data 2	input	high	CMOS input	
X31.a13	Data 3	input	high	CMOS input	
X31.a14	Data 4	input	high	CMOS input	
X31.a15	Data 5	input	high	CMOS input	
X31.a16	not used				
X31.a17	not used				
X31.a18	Transmit	input	high	CMOS input	
X31.a19	not used				

FSK MODEM • GM 852P2

Repair Manual • Interface Description

Contact	Signal Name Description	Direction	Type	Range of Value	Remarks
X31.a20	not used				
X31.a21	not used				
X31.a22	not used				
X31.a23	-16-V supply voltage	input	power	-16 V -1 V $V_{hum} \leq 10 \text{ mV}$ $I \leq 115 \text{ mA}$	
X31.a24	+ 5.3-V supply voltage	input	power	+ 5.3 V \pm 0.1 V $V_{hum} \leq 10 \text{ mV}$ $I \leq 420 \text{ mA}$ $I \leq 10 \text{ mA}$	if X31.b1 is high low
X31.a25	+ 5.3-V supply voltage	input	power	+ 5.3 V \pm 0.1 V $V_{hum} \leq 10 \text{ mV}$ $I \leq 420 \text{ mA}$ $I \leq 10 \text{ mA}$	if X31.b1 is high low
X31.a26	not used				
X31.a27	not used				
X31.a28	+ 16-V supply voltage	input	power	+ 16 V \pm 0.5 V $V_{hum} \leq 10 \text{ mV}$ $I \leq 45 \text{ mA}$	
X31.a29	+ 16-V supply voltage	input	power	+ 16 V \pm 0.5 V $V_{hum} \leq 10 \text{ mV}$ $I \leq 45 \text{ mA}$	
X31.a30	Ground	bidirectional			
X31.a31	Ground	bidirectional			
X31.a32	Ground	bidirectional			
X31.b1	not used				
X31.b2	not used				
X31.b3	TTY Mod. Remote	input		high $\geq +3 \text{ V}$ low $\leq -3 \text{ V}$	IF frequency at X2 $\Delta\text{-f}$ $\Delta\text{+f}$

FSK MODEM • GM 852P2

Repair Manual • Interface Description

Contact	Signal Name Description	Direction	Type	Range of Value	Remarks
X31.b4	Ground	bidirectional			
X31.b5	TTY Demod. Local	output	high	high $\geq +3\text{ V}$ low $\leq -3\text{ V}$	IF frequency at X2 $\Delta\text{-f}$ $\Delta\text{+f}$
X31.b6	Ground	bidirectional			
X31.b7	TTY Mod. Local	input		high $\geq +3\text{ V}$ low $\leq -3\text{ V}$	IF frequency at X2 $\Delta\text{-f}$ $\Delta\text{+f}$
X31.b8	Ground	bidirectional			
X31.b9	Strobe 9	input	high	CMOS input	
X31.b10	Carrier enable	input	high	CMOS input	
X31.b11	F 1	input	high	CMOS input	switches on $+5.3\text{ V}$
X31.b12	Strobe 12	input	high	CMOS input	
X31.b13	not used				
X31.b14	not used				
X31.b15	not used				
X31.b16	not used				
X31.b17	not used				
X31.b18	not used				
X31.b19	not used				
X31.b20	not used				
X31.b21	not used				
X31.b22	Shift	output		100 % shift $4.25 \pm 0.3\text{ V}$ $R_i \leq 500\ \Omega$	

FSK MODEM • GM 852P2

Repair Manual • Interface Description

Contact	Signal Name Description	Direction	Type	Range of Value	Remarks
X31.b23	-16-V supply voltage	input	power	-16 V -1 V $V_{hum} \leq 10 \text{ mV}$ $I \leq 115 \text{ mA}$	
X31.b24	+ 5.3-V supply voltage	input	power	+ 5.3 V \pm 0.1 V $V_{hum} \leq 10 \text{ mV}$ $I \leq 420 \text{ mA}$ $I \leq 10 \text{ mA}$	if X31.b1 is high low
X31.b25	+ 5.3-V supply voltage	input	power	+ 5.3 V \pm 0.1 V $V_{hum} \leq 10 \text{ mV}$ $I \leq 420 \text{ mA}$ $I \leq 10 \text{ mA}$	if X31.b1 is high low
X31.b26	not used				
X31.b27	not used				
X31.b28	+ 16-V supply voltage	input	power	+ 16 V \pm 0.5 V $V_{hum} \leq 10 \text{ mV}$ $I \leq 45 \text{ mA}$	
X31.b29	+ 16-V supply voltage	input	power	+ 16 V \pm 0.5 V $V_{hum} \leq 10 \text{ mV}$ $I \leq 45 \text{ mA}$	
X31.b30	Ground	bidirectional			
X31.b31	Ground	bidirectional			
X31.b32	Ground	bidirectional			
X32	FSK (IF)	bidirectional	output	Reception: 0 dBm / 50 Ω \pm 1 dB Transmit: 0 dBm / 50 Ω \pm 0.5 dB	

FSK MODEM • GM 852P2
 Repair Manual • Interface Description

Fig. 1 Characteristic CMOS Data, Series B

$V_{dd} = 5.3\text{ V}$

Parameter	Symbol	Value	Condition
Output voltage low	V_{ol}	0.05 V	$I_o \leq 1\ \mu\text{A}$
Output voltage high	V_{oh}	4.95 V	$I_o \leq 1\ \mu\text{A}$
Output voltage low	V_{ol}	1.5 V	$I_o \leq 1\ \mu\text{A}$
Output voltage high	V_{oh}	3.5 V	$I_o \leq 1\ \mu\text{A}$
Output current low	I_{ol}	0.36 mA	$V_o = 0.4\text{ V}$
Output current high	I_{oh}	0.36 mA	$V_o = 4.6\text{ V}$

Fig. 2

Δf at X32 in Reception	X31.a6	X31.a7
$\pm \geq 35\%$ of maximum shift	high	low
$\pm \geq 60\%$ of maximum shift	low	high
$\pm \geq 85\%$ of maximum shift	high	high
$+\Delta f$		low
$-\Delta f$		high

FSK MODEM • GM 852P2
 Repair Manual • Interface Description

Fig. 3 Characteristic Data

Supply voltage $V_{CC} = 5.3 \text{ V}$

Parameter	Symbol	Condition	Series 54...	Series 54...LS
Output current low	I_{ol}		16 mA	4 mA
Output current high	I_{oh}		-400 μA	-400 μA
Input voltage high	V_{ih}		$\geq 2 \text{ V}$	$\geq 2 \text{ V}$
Input voltage low	V_{il}		0.8 V	0.7 V
Negative input terminal voltage	V_{it}		-1.5 V	-1.5 V
Output voltage high	V_{oh}		$\geq 2.4 \text{ V}$	$\geq 2.5 \text{ V}$
Output voltage low	V_{ol}		$\leq 0.4 \text{ V}$	$\leq 0.5 \text{ V}$
Input current high	I_{ih}	$V_{ih} = 2.4 \text{ V}$ $V_{ih} = 2.7 \text{ V}$	40 μA	20 μA
Input current low	I_{il}	$V_{il} = 0.4 \text{ V}$	-1.6 mA	-0.4 mA

Kennz. Comp.No.	Benennung Designation	Sachnummer Stock No.	Hersteller Manufacturer	Bezeichnung Designation	enthalten in contained in
	VARIANTENERKL. / VERSIONS VAR 02 = GRUNDAUSFUEHRUNG MOD 02 = BASIC MODEL				
A3.1	ED FSK MODEM HIERZU STROML.646.4710.01S SEE CIRC.DIAG.646.4710.01S	646.4727.02			
W6	DX HF-KABEL RF CABLE	647.2557			
W13	DX HF-KABEL RF CABLE	647.2605			
					- ENDE -

ROHDE & SCHWARZ	Äl	Datum Date	Schaltteilliste für Parts list for	Sachnummer Stock No.	Blatt Page
	05	1090	GM852P2 FSK MODEM	646.4710.01 SA	1-

Für diese Unterlage behalten wir
uns alle Rechte vor

Kennz. Comp.No.	Benennung Designation	Sachnummer Stock No.	Hersteller Manufacturer	Bezeichnung Designation	enthalten in contained in
	VARIANTENERKL. / VERSIONS VAR 02 = GRUNDAUSFUHRUNG MOD 02 = BASIC MODEL				
C1	CK 3,9NF+-1%63V6,3QUX11KP CAPACITOR	CK 340.8057	SIEMENS	B33531-A5392-F	
C2	CK 3,9NF+-1%63V6,3QUX11KP CAPACITOR	CK 340.8057	SIEMENS	B33531-A5392-F	
C3	CK 3,9NF+-1%63V6,3QUX11KP CAPACITOR	CK 340.8057	SIEMENS	B33531-A5392-F	
C4	CK 3,9NF+-1%63V6,3QUX11KP CAPACITOR	CK 340.8057	SIEMENS	B33531-A5392-F	
C5	CC 100NF+-10%50V5K1200VIE CAPACITOR	CC 084.5350	UNION CARB	CK05BX104K	
C6	CC 100NF+-10%50V5K1200VIE CAPACITOR	CC 084.5350	UNION CARB	CK05BX104K	
C7	CC 100NF+-10%50V5K1200VIE CAPACITOR	CC 084.5350	UNION CARB	CK05BX104K	
C8	CC 100NF+-10%50V5K1200VIE CAPACITOR	CC 084.5350	UNION CARB	CK05BX104K	
C9	CC 100NF+-10%50V5K1200VIE CAPACITOR	CC 084.5350	UNION CARB	CK05BX104K	
C10	CC 10NF+-10%100V5K1200VIE CERAMIC CAPACITOR	CC 068.4060	UNION CARB	CK05BX103K	
C11	CC 10NF+-10%100V5K1200VIE CERAMIC CAPACITOR	CC 068.4060	UNION CARB	CK05BX103K	
C12	CC 10NF+-10%100V5K1200VIE CERAMIC CAPACITOR	CC 068.4060	UNION CARB	CK05BX103K	
C13	CK 8,2NF+-1%63V6,3QUX11KP CAPACITOR	CK 340.9060	SIEMENS	B33531-A5822-F	
C14	CK 220PF+-1%63V6,3QUX11KP CAPACITOR	CK 340.8040	SIEMENS	B33531-A5221-F	
C15	CC 10NF+-10%100V5K1200VIE CERAMIC CAPACITOR	CC 068.4060	UNION CARB	CK05BX103K	
C17	CC 10NF+-10%100V5K1200VIE CERAMIC CAPACITOR	CC 068.4060	UNION CARB	CK05BX103K	
C18	CC 10NF+-10%100V5K1200VIE CERAMIC CAPACITOR	CC 068.4060	UNION CARB	CK05BX103K	
C19	CC 10NF+-10%100V5K1200VIE CERAMIC CAPACITOR	CC 068.4060	UNION CARB	CK05BX103K	
C20	CC 10NF+-10%100V5K1200VIE CERAMIC CAPACITOR	CC 068.4060	UNION CARB	CK05BX103K	
C25	CC 1PF+-0,25PF3X4P100 CAPACITOR	CC 087.6170	PHILIPS-CO	2222 678 03108	
C26	CC 1NF+-10%63V K2000 CERAMIC CAPACITOR	CC 022.0784	PHILIPS-CO	2222 63051 102	
C27	CC 68PF+-2%6X7NPO CAPACITOR	CC 087.6529	PHILIPS-CO	2222 678 10689	
C28	CC 47PF+-2%5X6NPO CAPACITOR	CC 087.6506	PHILIPS-CO	2222 678 10479	
C29	CC 68PF+-2%6X7NPO CAPACITOR	CC 087.6529	PHILIPS-CO	2222 678 10689	
C30	CC 10NF+-10%100V5K1200VIE CERAMIC CAPACITOR	CC 068.4060	UNION CARB	CK05BX103K	
C31	CT 9PF 250V LUFTTR.KONZ. AIR TRIMMER	CT 564.6885	TEKELEC	AT 5276	
C34	CC 1PF+-0,25PF3X4P100 CAPACITOR	CC 087.6170	PHILIPS-CO	2222 678 03108	
C35	CC 1NF+-10%63V K2000 CERAMIC CAPACITOR	CC 022.0784	PHILIPS-CO	2222 63051 102	
C36	CC 10NF+-10%100V5K1200VIE CERAMIC CAPACITOR	CC 068.4060	UNION CARB	CK05BX103K	
C37	CC 10NF+-10%100V5K1200VIE CERAMIC CAPACITOR	CC 068.4060	UNION CARB	CK05BX103K	
C38	CC 2,7NF+- 5%100V NPO VIE CAPACITOR	060.0942	ERIE	8133-100-COG-2,7NF-J	
C39	CC 2,7NF+- 5%100V NPO VIE CAPACITOR	060.0942	ERIE	8133-100-COG-2,7NF-J	
C40	CC 2,7NF+- 5%100V NPO VIE CAPACITOR	060.0942	ERIE	8133-100-COG-2,7NF-J	
C44	CC 10NF+-10%100V5K1200VIE CERAMIC CAPACITOR	CC 068.4060	UNION CARB	CK05BX103K	
C45	CC 10NF+-10%100V5K1200VIE CERAMIC CAPACITOR	CC 068.4060	UNION CARB	CK05BX103K	
..48					
C49	CK 3,3NF+-1%63V6,3QUX11KP CAPACITOR	CK 340.9030	SIEMENS	B33531-A5332-F	
C50	CC 220PF+-2%6X7N750 CAPACITOR	CC 087.6941	PHILIPS-CO	2222 678 58221	

ROHDE & SCHWARZ

Äl Datum
Date
36 1192

Schaltteilliste für
Parts list for
ED FSK MODEM

Sachnummer
Stock No.
646.4727.01 SA

Blatt
Page
1+

Kennz. Comp.No.	Benennung Designation	Sachnummer Stock No.	Hersteller Manufacturer	Bezeichnung Designation	enthalten in contained in
C52 .55	CC 100NF+-10%50V5K1200VIE CAPACITOR	CC 084.5350	UNION CARB	CK05BX104K	
C56	CC 100NF+-10%50V5K1200VIE CAPACITOR	CC 084.5350	UNION CARB	CK05BX104K	
C57	CK 22NF+-5%63V RD2,5H7MKT CAPACITOR	CK 099.2881	WIMA	MKS2	
C58	CC 100NF+-10%50V5K1200VIE CAPACITOR	CC 084.5350	UNION CARB	CK05BX104K	
C61	CC 10NF+-10%100V5K1200VIE CERAMIC CAPACITOR	CC 068.4060	UNION CARB	CK05BX103K	
C62	CC 10NF+-10%100V5K1200VIE CERAMIC CAPACITOR	CC 068.4060	UNION CARB	CK05BX103K	
C63	CC 10NF+-10%100V5K1200VIE CERAMIC CAPACITOR	CC 068.4060	UNION CARB	CK05BX103K	
C67	CC 10NF+-10%100V5K1200VIE CERAMIC CAPACITOR	CC 068.4060	UNION CARB	CK05BX103K	
C68	CC 1,8NF+-10%100V5K1200VIE CERAMIC CAPACITOR	084.5296	UNION CARB	CK05BX182K	
C69	CC 1NF+-10%63V K2000 CERAMIC CAPACITOR	CC 022.0784	PHILIPS-CO	2222 63051 102	
C75	CK 1UF+-5% 50V RD5,5H11,5 CAPACITOR	CK 099.2998	WIMA	MKS2/50/1UF/5%	
C76	CK 220NF+-5%63VRD3,5H9MKT CAPACITOR	CK 099.2952	WIMA	MKS2	
C77	CK 100NF+-5%63VRD2,5H7MKT CAPACITOR	CK 099.2930	WIMA	MKS2	
C78	CC 56NF+-10%50V5K1200VIEL CERAMIC CAPACITOR	084.5338	UNION CARB	CK05BX563K	
C80	CC 10PF+-10%200V5K1200VIE CAPACITOR	CC 084.5138	UNION CARB	CK05BX100K	
C100	CC 100NF+-10%50V5K1200VIE CAPACITOR	CC 084.5350	UNION CARB	CK05BX104K	
C101	CC 100NF+-10%50V5K1200VIE CAPACITOR	CC 084.5350	UNION CARB	CK05BX104K	
C102	CC 100NF+-10%50V5K1200VIE CAPACITOR	CC 084.5350	UNION CARB	CK05BX104K	
C103	CC 10NF+-10%100V5K1200VIE CERAMIC CAPACITOR	CC 068.4060	UNION CARB	CK05BX103K	
C104	CC 10NF+-10%100V5K1200VIE CERAMIC CAPACITOR	CC 068.4060	UNION CARB	CK05BX103K	
C105	CC 1UF +-10% 50VK1200LR CAPACITOR	092.1015	AEROVOX	CKR06BX105KLEVELR	
C106	CC 10NF+-10%100V5K1200VIE CERAMIC CAPACITOR	CC 068.4060	UNION CARB	CK05BX103K	
C108	CK 8,2NF+-1%63V6,3QUX11KP CAPACITOR	CK 340.9060	SIEMENS	B33531-A5822-F	
C109	CK 220PF+-1%63V6,3QUX11KP CAPACITOR	CK 340.8040	SIEMENS	B33531-A5221-F	
C110	CC 100NF+-10%50V5K1200VIE CAPACITOR	CC 084.5350	UNION CARB	CK05BX104K	
C111	CC 10NF+-10%100V5K1200VIE CERAMIC CAPACITOR	CC 068.4060	UNION CARB	CK05BX103K	
C112	CK 1UF+-5% 50V RD5,5H11,5 CAPACITOR	CK 099.2998	WIMA	MKS2/50/1UF/5%	
C113	CK 470NF+-5%63V RD5H10MKT CAPACITOR	CK 099.2975	WIMA	MKS2	
C114	CK 1UF+-5% 50V RD5,5H11,5 CAPACITOR	CK 099.2998	WIMA	MKS2/50/1UF/5%	
C115	CC 100NF+-10%50V5K1200VIE CAPACITOR	CC 084.5350	UNION CARB	CK05BX104K	
C116	CK 100PF+-1%63V6,3QUX11KP CAPACITOR	CK 337.4654	SIEMENS	B33531-A5101-F	
C117	CK 1,8NF+-1%63V6,3X11 KP PLASTIC-FOIL CAPACITOR	CK 283.1699	SIEMENS	B33531-A5182-F	
C118	CC 100NF+-10%50V5K1200VIE CAPACITOR	CC 084.5350	UNION CARB	CK05BX104K	
C119	CC 10NF+-10%100V5K1200VIE CERAMIC CAPACITOR	CC 068.4060	UNION CARB	CK05BX103K	
C120	CC 10NF+-10%100V5K1200VIE CERAMIC CAPACITOR	CC 068.4060	UNION CARB	CK05BX103K	
C121	CC 10NF+-10%100V5K1200VIE CERAMIC CAPACITOR	CC 068.4060	UNION CARB	CK05BX103K	
C122	CC 10NF+-10%100V5K1200VIE CERAMIC CAPACITOR	CC 068.4060	UNION CARB	CK05BX103K	
C123	CC 1PF+-0,25PF3X4P100 CAPACITOR	CC 087.6170	PHILIPS-CO	2222 678 03108	
C124	CC 1NF+-10%63V K2000 CERAMIC CAPACITOR	CC 022.0784	PHILIPS-CO	2222 63051 102	

ROHDE & SCHWARZ	Äl	Datum Date	Schaltteilliste für Parts list for	Sachnummer Stock No.	Blatt Page
	36	1192	ED FSK MODEM	646.4727.01 SA	2+

Für diese Unterlage behalten wir uns alle Rechte vor

Kennz. Comp.No.	Benennung Designation	Sachnummer Stock No.	Hersteller Manufacturer	Bezeichnung Designation	enthalten in contained in
C129	CT 9PF 250V LUFTTR.KONZ. AIR TRIMMER	CT 564.6885	TEKELEC	AT 5276	
C130	CC 22PF+-2%4X5NPO CAPACITOR	CC 087.6464	PHILIPS-CO	2222 678 10229	
C131	CC 15PF+-2%3X4NPO CAPACITOR	CC 087.6441	PHILIPS-CO	2222 678 10159	
C132	CC 27PF+-2%4X5NPO CAPACITOR	CC 087.6470	PHILIPS-CO	2222 678 10279	
C133	CC 10NF+-10%100V5K1200VIE CERAMIC CAPACITOR	CC 068.4060	UNION CARB	CK05BX103K	
C134	CC 1PF+-0,25PF3X4P100 CAPACITOR	CC 087.6170	PHILIPS-CO	2222 678 03108	
C135	CC 1NF+-10%63V K2000 CERAMIC CAPACITOR	CC 022.0784	PHILIPS-CO	2222 63051 102	
C136	CC 10NF+-10%100V5K1200VIE CERAMIC CAPACITOR	CC 068.4060	UNION CARB	CK05BX103K	
C137	CC 10NF+-10%100V5K1200VIE CERAMIC CAPACITOR	CC 068.4060	UNION CARB	CK05BX103K	
C138	CC 10ONF+-10%50V5K1200VIE CAPACITOR	CC 084.5350	UNION CARB	CK05BX104K	
C140	CC 10NF+-10%100V5K1200VIE CERAMIC CAPACITOR	CC 068.4060	UNION CARB	CK05BX103K	
C200 ..203	CC 10ONF+-10%50V5K1200VIE CAPACITOR	CC 084.5350	UNION CARB	CK05BX104K	
C204	CC 10ONF+-10%50V5K1200VIE CAPACITOR	CC 084.5350	UNION CARB	CK05BX104K	
C205	CC 10ONF+-10%50V5K1200VIE CAPACITOR	CC 084.5350	UNION CARB	CK05BX104K	
C206	CC 10ONF+-10%50V5K1200VIE CAPACITOR	CC 084.5350	UNION CARB	CK05BX104K	
C207	CC 10NF+-10%100V5K1200VIE CERAMIC CAPACITOR	CC 068.4060	UNION CARB	CK05BX103K	
C208	CC 10ONF+-10%50V5K1200VIE CAPACITOR	CC 084.5350	UNION CARB	CK05BX104K	
C209	CC 10ONF+-10%50V5K1200VIE CAPACITOR	CC 084.5350	UNION CARB	CK05BX104K	
C210	CK 2,2NF+-1%63V 6,3QUAD. CAPACITOR	CK 099.1304	SIEMENS	B33531-A5222-F	
C211	CK 1,8NF+-1%63V6,3X11 KP PLASTIC-FOIL CAPACITOR	CK 283.1699	SIEMENS	B33531-A5182-F	
C212	CC 15PF+-2%3X4NPO CAPACITOR	CC 087.6441	PHILIPS-CO	2222 678 10159	
C213	CK 1NF+-1,25%63V7,5QUAD. CAPACITOR	CK 213.4353	SIEMENS	B33531-A5102-F	
C214	CK 10ONF+-5%63VRD2,5H7MKT CAPACITOR	CK 099.2930	WIMA	MKS2	
C215	CC 1NF+-10%63V K2000 CERAMIC CAPACITOR	CC 022.0784	PHILIPS-CO	2222 63051 102	
C216	CC 10NF+-10%100V5K1200VIE CERAMIC CAPACITOR	CC 068.4060	UNION CARB	CK05BX103K	
C217	CC 10NF+-10%100V5K1200VIE CERAMIC CAPACITOR	CC 068.4060	UNION CARB	CK05BX103K	
C218	CC 1UF +-10% 50VK1200LR CAPACITOR	092.1015	AEROVOX	CKR06BX105KLEVELR	
C219	CC 1NF+-10%63V K2000 CERAMIC CAPACITOR	CC 022.0784	PHILIPS-CO	2222 63051 102	
C220	CC 10ONF+-10%50V5K1200VIE CAPACITOR	CC 084.5350	UNION CARB	CK05BX104K	
C222	CC 10ONF+-10%50V5K1200VIE CAPACITOR	CC 084.5350	UNION CARB	CK05BX104K	
C223	CC 1NF+-10%63V K2000 CERAMIC CAPACITOR	CC 022.0784	PHILIPS-CO	2222 63051 102	
C225	CE RICHTIG SNR.0008.7510 ELECTROLYTIC CAPACITOR	CE 006.7165	ROEDERST	EK 00CB 310 D	
C226	CC 10ONF+-10%50V5K1200VIE CAPACITOR	CC 084.5350	UNION CARB	CK05BX104K	
C227	CC 10ONF+-10%50V5K1200VIE CAPACITOR	CC 084.5350	UNION CARB	CK05BX104K	
C228	CE 100UF+-20%35V RM5 ELECTROLYTIC CAPACITOR	008.7510	PHILIPS CO	2222 116 90042	
C230	CC 10ONF+-10%50V5K1200VIE CAPACITOR	CC 084.5350	UNION CARB	CK05BX104K	
C231	CC 10ONF+-10%50V5K1200VIE CAPACITOR	CC 084.5350	UNION CARB	CK05BX104K	
C232	CE 100UF+-20%35V RM5 ELECTROLYTIC CAPACITOR	008.7510	PHILIPS CO	2222 116 90042	
C233	CE RICHTIG SNR.0008.7510 ELECTROLYTIC CAPACITOR	CE 006.7165	ROEDERST	EK 00CB 310 D	

ROHDE & SCHWARZ	Äl	Datum Date	Schaltteilliste für Parts list for	Sachnummer Stock No.	Blatt Page
	36	1192	ED FSK MODEM	646.4727.01 SA	3+

Kennz. Comp.No.	Benennung Designation	Sachnummer Stock No.	Hersteller Manufacturer	Bezeichnung Designation	enthalten in contained in
C240	CC 560PF+-10%200V5K 1200VI CAPACITOR	082.7462	UNION CARB	CK05BX561K	
C243	CC 560PF+-10%200V5K 1200VI CAPACITOR	082.7462	UNION CARB	CK05BX561K	
C244	CC 560PF+-10%200V5K 1200VI CAPACITOR	082.7462	UNION CARB	CK05BX561K	
C245	CC 560PF+-10%200V5K 1200VI CAPACITOR	082.7462	UNION CARB	CK05BX561K	
C246	CC 560PF+-10%200V5K 1200VI CAPACITOR	082.7462	UNION CARB	CK05BX561K	
C247	CC 560PF+-10%200V5K 1200VI CAPACITOR	082.7462	UNION CARB	CK05BX561K	
C248	CC 560PF+-10%200V5K 1200VI CAPACITOR	082.7462	UNION CARB	CK05BX561K	
C249	CC 560PF+-10%200V5K 1200VI CAPACITOR	082.7462	UNION CARB	CK05BX561K	
C250	CC 560PF+-10%200V5K 1200VI CAPACITOR	082.7462	UNION CARB	CK05BX561K	
C251	CC 560PF+-10%200V5K 1200VI CAPACITOR	082.7462	UNION CARB	CK05BX561K	
C252	CC 560PF+-10%200V5K 1200VI CAPACITOR	082.7462	UNION CARB	CK05BX561K	
C253	CC 1,8NF+-10%100V5K 1200VI CERAMIC CAPACITOR	084.5296	UNION CARB	CK05BX182K	
C254	CC 560PF+-10%200V5K 1200VI CAPACITOR	082.7462	UNION CARB	CK05BX561K	
C255	CC 100NF+-10%50V5K 1200VIE CAPACITOR	CC 084.5350	UNION CARB	CK05BX104K	
C256	CC 1NF+-10%63V K2000 CERAMIC CAPACITOR	CC 022.0784	PHILIPS-CO	2222 63051 102	
C257	CC 1,8NF+-10%100V5K 1200VI CERAMIC CAPACITOR	084.5296	UNION CARB	CK05BX182K	
C258	CC 1,8NF+-10%100V5K 1200VI CERAMIC CAPACITOR	084.5296	UNION CARB	CK05BX182K	
C259	CC 560PF+-10%200V5K 1200VI CAPACITOR	082.7462	UNION CARB	CK05BX561K	
D1	BL CD4046BF PHASE-L-L. PHASE LOCKED LOOP	530.6060	RCA	CD4046BF	
D2	BL CD40192BF DEC.COUNTER COUNTER	302.7940	RCA	CD40192BF	
D3	BL CD40192BF DEC.COUNTER COUNTER	302.7940	RCA	CD40192BF	
D4	BL SN54LS169 J BIN.COUNT. IC BIN.COUNTER SN54LS69J	580.9340	FAIRCHILD	54LS169DM	
D5	BL SN54LS74J 2XD-FLIPFLOP IC FLIP FLOP SN54LS74J	275.0697	TEXAS	SN54LS74J	
D6	BL SN54LS74J 2XD-FLIPFLOP IC FLIP FLOP SN54LS74J	275.0697	TEXAS	SN54LS74J	
D7	BL SN5474J 2XD-FLIPFL FLIP FLOP	418.1219	TEXAS	SN5474J	
D8	BL CD40192BF DEC.COUNTER COUNTER	302.7940	RCA	CD40192BF	
D9	BL MC14538BAL 2X MONOFLOP MONOSTABLE MULTIVIBRATOR	526.5427	MOTOROLA	MC14538BAL	
D10	BL CD4041UBF 4X DRIVER DRIVER	418.0012	RCA	CD4041UBF	
D11	BL CD4011BF 4X2IN.NANDG NAND GATE	517.7572	RCA	CD4011BF	
D13	BL SN54LS74J 2XD-FLIPFLOP IC FLIP FLOP SN54LS74J	275.0697	TEXAS	SN54LS74J	
D14	BL SN54LS00J 4/2JNP.NAND. IC NAND GATE SN54LS00J	455.2838	TEXAS	SN54LS00J	
D99	BL MC14584BAL 6XSCH.TRIGG SCHMITT TRIGGER	522.4549	MOTOROLA	MC1458BALD	
D100	BL CD40192BF DEC.COUNTER COUNTER	302.7940	RCA	CD40192BF	
D101	BL CD40193BE BIN.V/R CTR COUNTER	340.5858	RCA	CD40193BE	
D102	BL CD4046BF PHASE-L-L. PHASE LOCKED LOOP	530.6060	RCA	CD4046BF	
D103	BL SN54LS169 J BIN.COUNT. IC BIN.COUNTER SN54LS69J	580.9340	FAIRCHILD	54LS169DM	
D104	BL SN54LS169 J BIN.COUNT. IC BIN.COUNTER SN54LS69J	580.9340	FAIRCHILD	54LS169DM	
D105	BL SN54LS169 J BIN.COUNT. IC BIN.COUNTER SN54LS69J	580.9340	FAIRCHILD	54LS169DM	

ROHDE & SCHWARZ	Äl	Datum Date	Schaltteilliste für Parts list for	Sachnummer Stock No.	Blatt Page
	36	1192	ED FSK MODEM	646.4727.01 SA	4+

Für diese Unterlage behalten wir uns alle Rechte vor

Kennz. Comp.No.	Benennung Designation	Sachnummer Stock No.	Hersteller Manufacturer	Bezeichnung Designation	enthalten in contained in
D106	BL SN54LS169 J BIN.COUNT. IC BIN.COUNTER SN54LS69J	580.9340	FAIRCHILD	54LS169DM	
D107	BL SN54LS00J 4/2JNP.NAND. IC NAND GATE SN54LS00J	455.2838	TEXAS	SN54LS00J	
D108	BL SN54LS10J 3/3INP.NAND IC NAND GATE SN54LS10J	455.2773	TEXAS INST	SN54LS10J	
D109	BL MM54C906J 6XN-CH.BUFF N-CHANNEL BUFFER OD	418.0264	NSC	MM54C906J	
D110	BL SN54LS169 J BIN.COUNT. IC BIN.COUNTER SN54LS69J	580.9340	FAIRCHILD	54LS169DM	
D111	BL SN54LS169 J BIN.COUNT. IC BIN.COUNTER SN54LS69J	580.9340	FAIRCHILD	54LS169DM	
D112	BL SN54LS169 J BIN.COUNT. IC BIN.COUNTER SN54LS69J	580.9340	FAIRCHILD	54LS169DM	
D200	BL SN54S113J 2/JK-FLIPFL. IC FLIP FLOP SN54S113N	475.1272	TEXAS	SN54S113J	
D201	BL SN54S113J 2/JK-FLIPFL. IC FLIP FLOP SN54S113N	475.1272	TEXAS	SN54S113J	
D202	BL SN54LS169 J BIN.COUNT. IC BIN.COUNTER SN54LS69J	580.9340	FAIRCHILD	54LS169DM	
D204	BL CD4041UBF 4X DRIVER DRIVER	418.0012	RCA	CD4041UBF	
D205	BL CD4041UBF 4X DRIVER DRIVER	418.0012	RCA	CD4041UBF	
D206	BL CD4041UBF 4X DRIVER DRIVER	418.0012	RCA	CD4041UBF	
D207	BL CD40174BF 6XD- FLIPFL FLIPFLOP	092.9474	RCA	CD40174BF	
D208	BL CD40174BF 6XD- FLIPFL FLIPFLOP	092.9474	RCA	CD40174BF	
D209	BL SN54LS00J 4/2JNP.NAND. IC NAND GATE SN54LS00J	455.2838	TEXAS	SN54LS00J	
D210	BL CD40174BF 6XD- FLIPFL FLIPFLOP	092.9474	RCA	CD40174BF	
K1	SN RELAIS 16V 1300 OHM RELAY	469.6676	SDS	RELAIS RH-16V	
L1	LD 10 UH 10% 3R3 144 MA CHOKE	LD 026.4184	DELEVAN	DROSSEL1025-44	
L2	LD 10 UH 10% 3R3 144 MA CHOKE	LD 026.4184	DELEVAN	DROSSEL1025-44	
L3	LD 10 UH 10% 3R3 144 MA CHOKE	LD ^o 026.4184	DELEVAN	DROSSEL1025-44	
L4	LD 10 UH 10% 3R3 144 MA CHOKE	LD 026.4184	DELEVAN	DROSSEL1025-44	
L5	LD 100 UH10%8,000HMO,084A CHOKE	LD 067.3101	DELEVAN	DROSSEL1025-68	
L6	LD 3,9UH 2% 1,25A OR155 HF-COIL	645.7439	JAHRE	74.11-3R90 TOL.+-2%	
L7	LD 10 UH 10% 3R3 144 MA CHOKE	LD 026.4184	DELEVAN	DROSSEL1025-44	
L8	LD 10 UH 10% 3R3 144 MA CHOKE	LD 026.4184	DELEVAN	DROSSEL1025-44	
L10	LD 10 UH 10% 3R3 144 MA CHOKE	LD 026.4184	DELEVAN	DROSSEL1025-44	
L11	LD 10 UH 10% 3R3 144 MA CHOKE	LD 026.4184	DELEVAN	DROSSEL1025-44	
L13	LD 100 UH10%8,000HMO,084A CHOKE	LD 067.3101	DELEVAN	DROSSEL1025-68	
L100	LD 10 UH 10% 3R3 144 MA CHOKE	LD 026.4184	DELEVAN	DROSSEL1025-44	
L101	LD 10 UH 10% 3R3 144 MA CHOKE	LD 026.4184	DELEVAN	DROSSEL1025-44	
L102	LD 100 UH10%8,000HMO,084A CHOKE	LD 067.3101	DELEVAN	DROSSEL1025-68	
L103	LD 100 UH10%8,000HMO,084A CHOKE	LD 067.3101	DELEVAN	DROSSEL1025-68	
L104	LD 3,9UH 2% 1,25A OR155 HF-COIL	645.7439	JAHRE	74.11-3R90 TOL.+-2	
L105	LD 10 UH 10% 3R3 144 MA CHOKE	LD 026.4184	DELEVAN	DROSSEL1025-44	
L106	LD 10 UH 10% 3R3 144 MA CHOKE	LD 026.4184	DELEVAN	DROSSEL1025-44	
L200	LD SPULE COIL	646.5052			
L201	LD SPULE COIL	646.5069			

ROHDE & SCHWARZ

Äl Datum
Date

36 1192

Schaltteilliste für
Parts list for

ED FSK MODEM

Sachnummer
Stock No.

646.4727.01 SA

Blatt
Page

5+

Kennz. Comp.No.	Benennung Designation	Sachnummer Stock No.	Hersteller Manufacturer	Bezeichnung Designation	enthalten in contained in
L202	LD 100 UH10%8,000HMO,084A CHOKE	LD 067.3101	DELEVAN	DROSSEL 1025-68	
L203	LD 0,33UH10%0,220HMO,830A CHOKE	LD 067.2805	DELEVAN	DROSSEL 1025--08	
L206	LD 10 UH 10% 3R3 144 MA CHOKE	LD 026.4184	DELEVAN	DROSSEL 1025-44	
L207	LD 10 UH 10% 3R3 144 MA CHOKE	LD 026.4184	DELEVAN	DROSSEL 1025-44	
N1	BO SE5534AFE LN OPAMP OPERATIONAL AMPLIFIER	BO 301.3335	SIGNETICS	SE5534AFE	
N2	BO SE5534AFE LN OPAMP OPERATIONAL AMPLIFIER	BO 301.3335	SIGNETICS	SE5534AFE	
N3	BO UA710H/883BDIFF COMPAR COMPARATOR	009.1039	NSC	LM710H/883B	
N4	BO UA710H/883BDIFF COMPAR COMPARATOR	009.1039	NSC	LM710H/883B	
N5	BO UA710H/883BDIFF COMPAR COMPARATOR	009.1039	NSC	LM710H/883B	
N6	BO MC1558JG 2X OPAMP OPERATIONAL AMPLIFIER	275.0816	NSC	LM1558J	
N7	BO LM139J 4X COMPAR COMPARATOR	BO 455.2873	NAT. SEMIC	LM139J	
N8	BO MC1558JG 2X OPAMP OPERATIONAL AMPLIFIER	275.0816	NSC	LM1558J	
N9	BO MC1558JG 2X OPAMP OPERATIONAL AMPLIFIER	275.0816	NSC	LM1558J	
N10	BL MC14066BAL 4X ANALOGSW ANALOG SWITCH	418.0135	MOTOROLA	MC14066BAL	
N100	BL MC14066BAL 4X ANALOGSW ANALOG SWITCH	418.0135	MOTOROLA	MC14066BAL	
N101	BO MC1558JG 2X OPAMP OPERATIONAL AMPLIFIER	275.0816	NSC	LM1558J	
N102	BO UA741MJG OPAMP OPERATIONAL AMPLIFIER	BO 275.0822	NAT. SEMIC	LM741J	
N103	BO UA710H/883BDIFF COMPAR COMPARATOR	009.1039	NSC	LM710H/883B	
N104	BO UA710H/883BDIFF COMPAR COMPARATOR	009.1039	NSC	LM710H/883B	
N200	BO LM139J 4X COMPAR COMPARATOR	BO 455.2873	NAT. SEMIC	LM139J	
N201	BL MC14066BAL 4X ANALOGSW ANALOG SWITCH	418.0135	MOTOROLA	MC14066BAL	
N202	BO UA78M12H+12VOA5 VREGL VOLTAGE REGULATOR	580.9362	SILICON GE	SG7812T	
N203	BO UA723DM ADJOA1 VREGL VOLTAGE REGULATOR	283.9425	RAYTHEON	RM-723D	
R1	RL 0,60W 8,25KOHM+-1%TK50 RESISTOR	RL 083.1239	DRALORIC	SMAO207/8,25K-F-D	
R2	RL 0,60W 56,2KOHM+-1%TK50 RESISTOR	RL 082.2231	DRALORIC	SMAO207/56,2K-F-C	
R3	RL 0,60W 33,2 OHM+-1%TK50 RESISTOR	RL 082.9359	DRALORIC	SMAO207/33,20HM-F-D	
R4	RL 0,60W 562 OHM+-1%TK50 RESISTOR	RL 083.0461	DRALORIC	SMAO207/5620HM-F-D	
R5	RL 0,60W 8,25KOHM+-1%TK50 RESISTOR	RL 083.1239	DRALORIC	SMAO207/8,25K-F-D	
R6	RL 0,60W 56,2KOHM+-1%TK50 RESISTOR	RL 082.2231	DRALORIC	SMAO207/56,2K-F-C	
R7	RL 0,60W 33,2 OHM+-1%TK50 RESISTOR	RL 082.9359	DRALORIC	SMAO207/33,20HM-F-D	
R8	RL 0,60W 562 OHM+-1%TK50 RESISTOR	RL 083.0461	DRALORIC	SMAO207/5620HM-F-D	
R9	RL 0,60W 47,5 OHM+-1%TK50 RESISTOR	RL 082.9507	DRALORIC	SMAO207/47,50HM-F-D	
R10	RL 0,60W 10,0KOHM+-1%TK50 RESISTOR	RL 083.1297	DRALORIC	SMAO207/10K-F-D	
R11	RL 0,60W 10,0KOHM+-1%TK50 RESISTOR	RL 083.1297	DRALORIC	SMAO207/10K-F-D	
R12	RS 0,5W50 OHM+-10%10X10X5 CERMET POTENTIOMETER T	RS 247.7861	BOURNS	3386F-1-500	
R13	RL 0,60W 47,5 OHM+-1%TK50 RESISTOR	RL 082.9507	DRALORIC	SMAO207/47,50HM-F-D	
R14	RS 0,5W50 OHM+-10%10X10X5 CERMET POTENTIOMETER T	RS 247.7861	BOURNS	3386F-1-500	
R15	RL 0,60W 10,0KOHM+-1%TK50 RESISTOR	RL 083.1297	DRALORIC	SMAO207/10K-F-D	

ROHDE & SCHWARZ	Äl	Datum Date	Schaltteilliste für Parts list for	Sachnummer Stock No.	Blatt Page
	36	1192	ED FSK MODEM	646.4727.01 SA	6+

Kennz. Comp.No.	Benennung Designation	Sachnummer Stock No.	Hersteller Manufacturer	Bezeichnung Designation	enthalten in contained in
R16	RL 0,60W 5,62KOHM+-1%TK50 RESISTOR	RL 082.2190	DRALORIC	SMA0207/5,62K-F-C	
R17	RL 0,60W 475 KOHM+-1%TK50 RESISTOR	RL 083.2593	DRALORIC	SMA0207/475K-F-C	
R18	RL 0,60W 10,0KOHM+-1%TK50 RESISTOR	RL 083.1297	DRALORIC	SMA0207/10K-F-D	
R19	RL 0,60W 10,0KOHM+-1%TK50 RESISTOR	RL 083.1297	DRALORIC	SMA0207/10K-F-D	
R20	RL 0,60W 10,0KOHM+-1%TK50 RESISTOR	RL 083.1297	DRALORIC	SMA0207/10K-F-D	
R21	RL 0,60W 10,0KOHM+-1%TK50 RESISTOR	RL 083.1297	DRALORIC	SMA0207/10K-F-D	
R22	RL 0,60W 10,0KOHM+-1%TK50 RESISTOR	RL 083.1297	DRALORIC	SMA0207/10K-F-D	
R23	RL 0,60W 3,92KOHM+-1%TK50 RESISTOR	RL 083.1039	RESISTA	MK2	
R24	RL 0,60W 1,82KOHM+-1%TK50 RESISTOR	RL 082.2277	DRALORIC	SMA0207/1,82K-F-C	
R25	RL 0,60W 10,0KOHM+-1%TK50 RESISTOR	RL 083.1297	DRALORIC	SMA0207/10K-F-D	
R26	RL 0,60W 4,75KOHM+-1%TK50 RESISTOR	RL 083.1097	DRALORIC	SMA0207/4,75K-F-D	
R30	RL 0,60W 5,62KOHM+-1%TK50 RESISTOR	RL 082.2190	DRALORIC	SMA0207/5,62K-F-C	
R31	RL 0,60W 5,62KOHM+-1%TK50 RESISTOR	RL 082.2190	DRALORIC	SMA0207/5,62K-F-C	
R32	RL 0,60W 10,0KOHM+-1%TK50 RESISTOR	RL 083.1297	DRALORIC	SMA0207/10K-F-D	
R33	RL 0,60W 10,0KOHM+-1%TK50 RESISTOR	RL 083.1297	DRALORIC	SMA0207/10K-F-D	
R34	RL 0,60W 15,0KOHM+-1%TK50 RESISTOR	RL 083.1400	DRALORIC	SMA0207/15K-F-D	
R35	RL 0,60W 22,1KOHM+-1%TK50 RESISTOR	RL 083.1545	DRALORIC	SMA/207/22,1K-F-C	
R36	RL 0,60W 100 OHM+-1%TK50 RESISTOR	RL 082.6543	DRALORIC	SMA0207/100/HM-F-D	
R37	RL 0,60W 475 OHM+-1%TK50 RESISTOR	RL 083.0390	DRALORIC	SMA0207/475OHM-F-D	
R38	RL 0,60W 475 OHM+-1%TK50 RESISTOR	RL 083.0390	DRALORIC	SMA0207/475OHM-F-D	
R40	RL 0,60W 10,0KOHM+-1%TK50 RESISTOR	RL 083.1297	DRALORIC	SMA0207/10K-F-D	
R43	RL 0,60W 10,0KOHM+-1%TK50 RESISTOR	RL 083.1297	DRALORIC	SMA0207/10K-F-D	
R44	RL 0,60W 10,0KOHM+-1%TK50 RESISTOR	RL 083.1297	DRALORIC	SMA0207/10K-F-D	
R45	RL 0,60W 33,2KOHM+-1%TK50 RESISTOR	RL 083.1674	DRALORIC	SMA0207/33,2K-F-C	
R46	RL 0,60W 33,2KOHM+-1%TK50 RESISTOR	RL 083.1674	DRALORIC	SMA0207/33,2K-F-C	
R47	RL 0,60W 33,2KOHM+-1%TK50 RESISTOR	RL 083.1674	DRALORIC	SMA0207/33,2K-F-C	
R48	RL 0,60W 9,09KOHM+-1%TK50 RESISTOR	RL 082.2177	DRALORIC	SMA0207/9,09K-F-C	
R50	RL 0,60W 15,0KOHM+-1%TK50 RESISTOR	RL 083.1400	DRALORIC	SMA0207/15K-F-D	
R55	RL 0,60W 2,74KOHM+-1%TK50 RESISTOR	RL 083.0926	DRALORIC	SMA0207/2,74K-F-D	
R56	RL 0,60W 10,0KOHM+-1%TK50 RESISTOR	RL 083.1297	DRALORIC	SMA0207/10K-F-D	
R58	RL 0,60W 6,81KOHM+-1%TK50 RESISTOR	RL 082.2560	DRALORIC	SMA 0207/6,81K-F-C	
R59	RL 0,60W 100KOHM+-1%TK50 RESISTOR	RL 082.1034	DRALORIC	SMA0207/100K-F-C	
R60	RL 0,60W 10,0KOHM+-1%TK50 RESISTOR	RL 083.1297	DRALORIC	SMA0207/10K-F-D	
R61	RL 0,60W 6,81KOHM+-1%TK50 RESISTOR	RL 082.2560	DRALORIC	SMA 0207/6,81K-F-C	
R62	RL 0,60W 22,1KOHM+-1%TK50 RESISTOR	RL 083.1545	DRALORIC	SMA/207/22,1K-F-C	
R63	RL 0,60W 8,25KOHM+-1%TK50 RESISTOR	RL 083.1239	DRALORIC	SMA0207/8,25K-F-D	
R64	RL 0,60W 10,0KOHM+-1%TK50 RESISTOR	RL 083.1297	DRALORIC	SMA0207/10K-F-D	
R65	RL 0,60W 10,0KOHM+-1%TK50 RESISTOR	RL 083.1297	DRALORIC	SMA0207/10K-F-D	

ROHDE & SCHWARZ	Är	Datum Date	Schaltteilliste für Parts list for	Sachnummer Stock No.	Blatt Page
		36 1192	ED FSK MODEM	646.4727.01 SA	7+

Kennz. Comp.No.	Benennung Designation	Sachnummer Stock No.	Hersteller Manufacturer	Bezeichnung Designation	enthalten in contained in
R66	RL 0,60W 1KOHM+-1%TK50 RESISTOR	RL 082.2160	DRALORIC	SMAO207/1K-F-C	
R67	RL 0,60W 10,0KOHM+-1%TK50 RESISTOR	RL 083.1297	DRALORIC	SMAO207/10K-F-D	
R68	RL 0,60W 1KOHM+-1%TK50 RESISTOR	RL 082.2160	DRALORIC	SMAO207/1K-F-C	
R69	RL 0,60W 1KOHM+-1%TK50 RESISTOR	RL 082.2160	DRALORIC	SMAO207/1K-F-C	
R70	RL 0,60W 10,0KOHM+-1%TK50 RESISTOR	RL 083.1297	DRALORIC	SMAO207/10K-F-D	
R71	RL 0,60W 5,62KOHM+-1%TK50 RESISTOR	RL 082.2190	DRALORIC	SMAO207/5,62K-F-C	
R72	RL 0,60W 2,74KOHM+-1%TK50 RESISTOR	RL 083.0926	DRALORIC	SMAO207/2,74K-F-D	
R73	RL 0,60W 33,2KOHM+-1%TK50 RESISTOR	RL 083.1674	DRALORIC	SMAO207/33,2K-F-C	
R74	RL 0,60W 3,32KOHM+-1%TK50 RESISTOR	RL 083.0990	DRALORIC	SMAO207/3,32K-F-D	
R75	RL 0,60W 5,62KOHM+-1%TK50 RESISTOR	RL 082.2190	DRALORIC	SMAO207/5,62K-F-C	
R76	RL 0,60W 5,62KOHM+-1%TK50 RESISTOR	RL 082.2190	DRALORIC	SMAO207/5,62K-F-C	
R77	RL 0,60W 5,62KOHM+-1%TK50 RESISTOR	RL 082.2190	DRALORIC	SMAO207/5,62K-F-C	
R78	RL 0,60W 10,0KOHM+-1%TK50 RESISTOR	RL 083.1297	DRALORIC	SMAO207/10K-F-D	
R79	RL 0,60W 33,2KOHM+-1%TK50 RESISTOR	RL 083.1674	DRALORIC	SMAO207/33,2K-F-C	
R80	RL 0,60W 6,81KOHM+-1%TK50 RESISTOR	RL 082.2560	DRALORIC	SMA 0207/6,81K-F-C	
R81	RL 0,60W 10,0KOHM+-1%TK50 RESISTOR	RL 083.1297	DRALORIC	SMAO207/10K-F-D	
R82	RL 0,60W 82,5KOHM+-1%TK50 RESISTOR	RL 082.2302	DRALORIC	SMAO207/82,5K-F-C	
R83	RL 0,60W 10,0KOHM+-1%TK50 RESISTOR	RL 083.1297	DRALORIC	SMAO207/10K-F-D	
R84	RL 0,60W 10,0KOHM+-1%TK50 RESISTOR	RL 083.1297	DRALORIC	SMAO207/10K-F-D	
R85	RL 0,60W 12,1KOHM+-1%TK50 RESISTOR	RL 083.1351	DRALORIC	SMAO207/12,1K-F-D	
R86	RL 0,60W 10,0KOHM+-1%TK50 RESISTOR	RL 083.1297	DRALORIC	SMAO207/10K-F-D	
R87	RL 0,60W 121KOHM+-1%TK50 RESISTOR	RL 083.2070	DRALORIC	SMA/207/121K-F-C	
R88	RL 0,60W 22,1KOHM+-1%TK50 RESISTOR	RL 083.1545	DRALORIC	SMA/207/22,1K-F-C	
R89	RL 0,60W 5,62KOHM+-1%TK50 RESISTOR	RL 082.2190	DRALORIC	SMAO207/5,62K-F-C	
R90	RL 0,60W 33,2KOHM+-1%TK50 RESISTOR	RL 083.1674	DRALORIC	SMAO207/33,2K-F-C	
R91	RL 0,60W 10,0KOHM+-1%TK50 RESISTOR	RL 083.1297	DRALORIC	SMAO207/10K-F-D	
R92	RL 0,60W 150 KOHM+-1%TK50 RESISTOR	RL 083.2129	DRALORIC	SMA/207/150K-F-C	
R93	RL 0,60W 39,2KOHM+-1%TK50 RESISTOR	RL 083.1745	DRALORIC	SMA/207/39,2K-F-C	
R94	RL 0,60W 10,0KOHM+-1%TK50 RESISTOR	RL 083.1297	DRALORIC	SMAO207/10K-F-D	
R95	RL 0,60W 4,75KOHM+-1%TK50 RESISTOR	RL 083.1097	DRALORIC	SMAO207/4,75K-F-D	
R96	RL 0,60W 4,75KOHM+-1%TK50 RESISTOR	RL 083.1097	DRALORIC	SMAO207/4,75K-F-D	
R97	RL 0,60W 4,75KOHM+-1%TK50 RESISTOR	RL 083.1097	DRALORIC	SMAO207/4,75K-F-D	
R98	RL 0,60W 10,0KOHM+-1%TK50 RESISTOR	RL 083.1297	DRALORIC	SMAO207/10K-F-D	
R100 ..103	RL 0,60W 5,62KOHM+-1%TK50 RESISTOR	RL 082.2190	DRALORIC	SMAO207/5,62K-F-C	
R104	RL 0,60W 33,2KOHM+-1%TK50 RESISTOR	RL 083.167	DRALORIC	SMAO207/33,2K-F-C	
R105	RL 0,60W 100KOHM+-1%TK50 RESISTOR	RL 082.1764	DRALORIC	SMAO207/100K-F-C	
R106	RL 0,60W 82,5KOHM+-1%TK50 RESISTOR	RL 082.2302	DRALORIC	SMAO207/82,5K-F-C	
R107 ..111	RL 0,60W 10,0KOHM+-1%TK50 RESISTOR	RL 083.1297	DRALORIC	SMAO207/10K-F-D	
R115	RL 0,60W 10,0KOHM+-1%TK50 RESISTOR	RL 083.1297	DRALORIC	SMAO207/10K-F-D	

ROHDE & SCHWARZ	Äl	Datum Date	Schaltteilliste für Parts list for	Sachnummer Stock No.	Blatt Page
	36	1192	ED FSK MODEM	646.4727.01 SA	8+

Für diese Unterlage behalten wir uns alle Rechte vor

Kennz. Comp.No.	Benennung Designation	Sachnummer Stock No.	Hersteller Manufacturer	Bezeichnung Designation	enthalten in contained in
R116	RL 0,60W 10,0KOHM+-1%TK50 RESISTOR	RL 083.1297	DRALORIC	SMA0207/10K-F-D	
R117	RL 0,60W 27,4KOHM+-1%TK50 RESISTOR	RL 082.2583	DRALORIC	SMA 0207/27,4K-F-C	
R118	RL 0,60W 221 KOHM+-1%TK50 RESISTOR	RL 083.2270	DRALORIC	SMA0207/221K-F-C	
R119	RL 0,60W 15,0KOHM+-1%TK50 RESISTOR	RL 083.1400	DRALORIC	SMA0207/15K-F-D	
R120	RL 0,60W 6,81KOHM+-1%TK50 RESISTOR	RL 082.2560	DRALORIC	SMA 0207/6,81K-F-C	
R121	RL 0,60W 8,25KOHM+-1%TK50 RESISTOR	RL 083.1239	DRALORIC	SMA0207/8,25K-F-D	
R122	RL 0,60W 10,0KOHM+-1%TK50 RESISTOR	RL 083.1297	DRALORIC	SMA0207/10K-F-D	
R123	RL 0,60W 6,81KOHM+-1%TK50 RESISTOR	RL 082.2560	DRALORIC	SMA 0207/6,81K-F-C	
R124	RS 0,5W10KOHM+-10%10X10X5 CERMET POTENTIOMETER T	RS 247.7903	BOURNS	3386F-1-103	
R125	RL 0,60W 10,0KOHM+-1%TK50 RESISTOR	RL 083.1297	DRALORIC	SMA0207/10K-F-D	
R126	RL 0,60W 10,0KOHM+-1%TK50 RESISTOR	RL 083.1297	DRALORIC	SMA0207/10K-F-D	
R129	RL 0,60W 10,0KOHM+-1%TK50 RESISTOR	RL 083.1297	DRALORIC	SMA0207/10K-F-D	
R130	RL 0,60W 15,0KOHM+-1%TK50 RESISTOR	RL 083.1400	DRALORIC	SMA0207/15K-F-D	
R131	RL 0,60W 100KOHM+-1%TK50 RESISTOR	RL 082.1764	DRALORIC	SMA0207/100K-F-C	
R132	RL 0,60W 100 OHM+-1%TK50 RESISTOR	RL 082.6543	DRALORIC	SMA0207/100/HM-F-D	
R133	RL 0,60W 475 OHM+-1%TK50 RESISTOR	RL 083.0390	DRALORIC	SMA0207/475OHM-F-D	
R134	RL 0,60W 475 OHM+-1%TK50 RESISTOR	RL 083.0390	DRALORIC	SMA0207/475OHM-F-D	
R135	RL 0,60W 10,0KOHM+-1%TK50 RESISTOR	RL 083.1297	DRALORIC	SMA0207/10K-F-D	
R136	RL 0,60W 10,0KOHM+-1%TK50 RESISTOR	RL 083.1297	DRALORIC	SMA0207/10K-F-D	
R150	RL 0,60W 475 KOHM+-1%TK50 RESISTOR	RL 083.2593	DRALORIC	SMA0207/475K-F-C	
R151	RL 0,60W 221 KOHM+-1%TK50 RESISTOR	RL 083.2270	DRALORIC	SMA0207/221K-F-C	
R152	RL 0,60W 10,0KOHM+-1%TK50 RESISTOR	RL 083.1297	DRALORIC	SMA0207/10K-F-D	
R200	RL 0,60W 1KOHM+-1%TK50 RESISTOR	RL 082.2160	DRALORIC	SMA0207/1K-F-C	
R204	RL 0,60W 6,04KOHM+-1%TK50 RESISTOR	RL 082.6089	DRALORIC	SMA 0207/6,04OHM-F-C	
R205	RL 0,60W 6,04KOHM+-1%TK50 RESISTOR TRIMMWERT / SELECTED	RL 082.6089	DRALORIC	SMA 0207/6,04OHM-F-C	
R206	RL 0,60W 3,32KOHM+-1%TK50 RESISTOR	RL 083.0990	DRALORIC	SMA0207/3,32K-F-D	
R207	RL 0,60W 18,2KOHM+-1%TK50 RESISTOR	RL 083.1480	DRALORIC	SMA/207/18,2K-F-C	
R208	RL 0,60W 100 OHM+-1%TK50 RESISTOR	RL 082.6543	DRALORIC	SMA0207/100/HM-F-D	
R209	RL 0,60W 475 OHM+-1%TK50 RESISTOR	RL 083.0390	DRALORIC	SMA0207/475OHM-F-D	
R210	RL 0,60W 47,5 OHM+-1%TK50 RESISTOR	RL 082.9507	DRALORIC	SMA0207/47,5OHM-F-D	
R211	RL 0,60W 15,0KOHM+-1%TK50 RESISTOR	RL 083.1400	DRALORIC	SMA0207/15K-F-D	
R215	RL 0,60W 2,21KOHM+-1%TK50 RESISTOR	RL 082.2477	DRALORIC	SMA 0207/2,21K-F-C	
R216	RL 0,60W 22,1KOHM+-1%TK50 RESISTOR	RL 083.1545	DRALORIC	SMA/207/22,1K-F-C	
R217	RL 0,60W 22,1KOHM+-1%TK50 RESISTOR	RL 083.1545	DRALORIC	SMA/207/22,1K-F-C	
R218	RS 0,5W1KOHM+-10%10X10X5 CERMET POTENTIOMETER T	RS 087.7560	BOURNS	3386F-1-102	
R219	RL 0,60W 2,21KOHM+-1%TK50 RESISTOR	RL 082.2477	DRALORIC	SMA 0207/2,21K-F-C	
R220	RL 0,60W 5,62KOHM+-1%TK50 RESISTOR	RL 082.2190	DRALORIC	SMA0207/5,62K-F-C	
R221	RL 0,60W 1KOHM+-1%TK50 RESISTOR	RL 082.2160	DRALORIC	SMA0207/1K-F-C	
R224					

ROHDE & SCHWARZ

Äl Datum
Date

36 1192

Schaltteilliste für
Parts list for

ED FSK MODEM

Sachnummer
Stock No.

646.4727.01 SA

Blatt
Page

9+

Kennz. Comp.No.	Benennung Designation	Sachnummer Stock No.	Hersteller Manufacturer	Bezeichnung Designation	enthalten in contained in
R225	RL 0,60W 3,92KOHM+-1%TK50 RESISTOR	RL 083.1039	RESISTA	MK2	
R226	RL 0,60W 3,92KOHM+-1%TK50 RESISTOR	RL 083.1039	RESISTA	MK2	
R227	RL 0,60W 2,21KOHM+-1%TK50 RESISTOR	RL 082.2477	DRALORIC	SMA 0207/2,21K-F-C	
R228	RL 0,60W 22,1KOHM+-1%TK50 RESISTOR	RL 083.1545	DRALORIC	SMA/207/22,1K-F-C	
R229	RL 0,60W 22,1KOHM+-1%TK50 RESISTOR	RL 083.1545	DRALORIC	SMA/207/22,1K-F-C	
R230	RL 0,60W 2,21KOHM+-1%TK50 RESISTOR	RL 082.2477	DRALORIC	SMA 0207/2,21K-F-C	
R232	RL 0,60W 6,81KOHM+-1%TK50 RESISTOR	RL 082.2560	DRALORIC	SMA 0207/6,81K-F-C	
R238	RL 0,60W 1KOHM+-1%TK50 RESISTOR	RL 082.2160	DRALORIC	SMA0207/1K-F-C	
R239	RL 0,60W 3,32KOHM+-1%TK50 RESISTOR	RL 083.0990	DRALORIC	SMA0207/3,32K-F-D	
R240	RL 0,60W 182 OHM+-1%TK50 RESISTOR	RL 083.0010	DRALORIC	SMA0207/182OHM-F-D	
R241	RL 0,60W 1KOHM+-1%TK50 RESISTOR	RL 082.2160	DRALORIC	SMA0207/1K-F-C	
R242	RL 0,60W 100 OHM+-1%TK50 RESISTOR	RL 082.6543	DRALORIC	SMA0207/100/HM-F-D	
R243 ..246	RL 0,60W 10,0KOHM+-1%TK50 RESISTOR	RL 083.1297	DRALORIC	SMA0207/10K-F-D	
R247	RL 0,60W 56,2KOHM+-1%TK50 RESISTOR	RL 082.2231	DRALORIC	SMA0207/56,2K-F-C	
R248	RL 0,60W 27,4KOHM+-1%TK50 RESISTOR	RL 082.2583	DRALORIC	SMA 0207/27,4K-F-C	
R249	RL 0,60W 18,2KOHM+-1%TK50 RESISTOR	RL 083.1480	DRALORIC	SMA/207/18,2K-F-C	
R250	RL 0,60W 56,2KOHM+-1%TK50 RESISTOR	RL 082.2231	DRALORIC	SMA0207/56,2K-F-C	
R251	RL 0,60W 1,82KOHM+-1%TK50 RESISTOR	RL 082.2277	DRALORIC	SMA0207/1,82K-F-C	
R252	RL 0,60W 2,74KOHM+-1%TK50 RESISTOR	RL 083.0926	DRALORIC	SMA0207/2,74K-F-D	
R253	RL 0,60W 10,0KOHM+-1%TK50 RESISTOR	RL 083.1297	DRALORIC	SMA0207/10K-F-D	
R254	RL 0,60W 10,0KOHM+-1%TK50 RESISTOR	RL 083.1297	DRALORIC	SMA0207/10K-F-D	
R255	RL 0,60W 5,62KOHM+-1%TK50 RESISTOR	RL 082.2190	DRALORIC	SMA0207/5,62K-F-C	
R256	RL 0,60W 22,1KOHM+-1%TK50 RESISTOR	RL 083.1545	DRALORIC	SMA/207/22,1K-F-C	
R257	RL 0,60W 22,1KOHM+-1%TK50 RESISTOR	RL 083.1545	DRALORIC	SMA/207/22,1K-F-C	
R258	RL 0,60W 82,5KOHM+-1%TK50 RESISTOR	RL 082.2302	DRALORIC	SMA0207/82,5K-F-C	
R260	RL 0,60W 4,75KOHM+-1%TK50 RESISTOR	RL 083.1097	DRALORIC	SMA0207/4,75K-F-D	
R261 ..266	RL 0,60W 4,75KOHM+-1%TK50 RESISTOR	RL 083.1097	DRALORIC	SMA0207/4,75K-F-D	
R267	RL 0,60W 4,75KOHM+-1%TK50 RESISTOR	RL 083.1097	DRALORIC	SMA0207/4,75K-F-D	
R268	RL 0,60W 4,75KOHM+-1%TK50 RESISTOR	RL 083.1097	DRALORIC	SMA0207/4,75K-F-D	
R269	RL 0,60W 4,75KOHM+-1%TK50 RESISTOR	RL 083.1097	DRALORIC	SMA0207/4,75K-F-D	
R271 ..273	RL 0,60W 4,75KOHM+-1%TK50 RESISTOR	RL 083.1097	DRALORIC	SMA0207/4,75K-F-D	
R275	RL 0,60W 5,62KOHM+-1%TK50 RESISTOR	RL 082.2190	DRALORIC	SMA0207/5,62K-F-C	
R276	RL 0,60W 15,0KOHM+-1%TK50 RESISTOR	RL 083.1400	DRALORIC	SMA0207/15K-F-D	
R277	RL 0,60W 5,62KOHM+-1%TK50 RESISTOR	RL 082.2190	DRALORIC	SMA0207/5,62K-F-C	
R278	RL 0,60W 5,62KOHM+-1%TK50 RESISTOR	RL 082.2190	DRALORIC	SMA0207/5,62K-F-C	
R279	RL 0,60W 10,0KOHM+-1%TK50 RESISTOR	RL 083.1297	DRALORIC	SMA0207/10K-F-D	
R280	RL 0,60W 10,0KOHM+-1%TK50 RESISTOR	RL 083.1297	DRALORIC	SMA0207/10K-F-D	
R281	RL 0,60W 5,62KOHM+-1%TK50 RESISTOR	RL 082.2190	DRALORIC	SMA0207/5,62K-F-C	
R282	RL 0,60W 5,62KOHM+-1%TK50 RESISTOR	RL 082.2190	DRALORIC	SMA0207/5,62K-F-C	

ROHDE & SCHWARZ	Äl	Datum Date	Schaltteilliste für Parts list for	Sachnummer Stock No.	Blatt Page
	36	1192			

Für diese Unterlage behalten wir uns alle Rechte vor

Kennz. Comp.No.	Benennung Designation	Sachnummer Stock No.	Hersteller Manufacturer	Bezeichnung Designation	enthalten in contained in
R283	RL 0,60W 15,0KOHM+-1%TK50 RESISTOR	RL 083.1400	DRALORIC	SMA0207/15K-F-D	
R284	RL 0,60W 5,62KOHM+-1%TK50 RESISTOR	RL 082.2190	DRALORIC	SMA0207/5,62K-F-C	
R285	RL 0,60W 10,0KOHM+-1%TK50 RESISTOR	RL 083.1297	DRALORIC	SMA0207/10K-F-D	
R286	RL 0,60W 10,0KOHM+-1%TK50 RESISTOR	RL 083.1297	DRALORIC	SMA0207/10K-F-D	
R287	RL 0,60W 5,62KOHM+-1%TK50 RESISTOR	RL 082.2190	DRALORIC	SMA0207/5,62K-F-C	
R288	RL 0,60W4,75 OHM+-1%TK50 METALFILMRESISTOR	RL 099.8021	RESISTA	MK2 4,75 OHM 1% TK50	
R289	RL 0,60W 10,0 OHM+-1%TK50 RESISTOR	RL 082.8852	DRALORIC	SMA0207/100HM-F-D	
R290	RL 0,60W 4,32KOHM+-1%TK50 RESISTOR	RL 082.6572	DRALORIC	SMA0207/4,32K-F-D	
R291	RL 0,60W 10,0KOHM+-1%TK50 RESISTOR	RL 083.1297	DRALORIC	SMA0207/10K-F-D	
R292	RL 0,60W 3,32KOHM+-1%TK50 RESISTOR	RL 083.0990	DRALORIC	SMA0207/3,32K-F-D	
R293	RL 0,60W 3,32KOHM+-1%TK50 RESISTOR	RL 083.0990	DRALORIC	SMA0207/3,32K-F-D	
R294	RL 0,60W 5,62KOHM+-1%TK50 RESISTOR	RL 082.2190	DRALORIC	SMA0207/5,62K-F-C	
R295	RL 0,60W 2,21KOHM+-1%TK50 RESISTOR	RL 082.2477	DRALORIC	SMA 0207/2,21K-F-C	
U200	BO LM1596 MOD/DEMOMODULATOR/DEMOMODULATOR	417.0419	MOTOROLA	MC1596G	
U201	BO LM1596 MOD/DEMOMODULATOR/DEMOMODULATOR	417.0419	MOTOROLA	MC1596G	
V1	AE 5082-2800 SCHOTTKY DIODE	AE 012.9066	HEWLETT-P.	5082-2800	
V2	AK BFY90 N 15V 25MA TRANSISTOR	AK 010.4550	PHILIPS-CO	BFY90	
V3	AK BFY90 N 15V 25MA TRANSISTOR	AK 010.4550	PHILIPS-CO	BFY90	
V4	AE 5082-2800 SCHOTTKY DIODE	AE 012.9066	HEWLETT-P.	5082-2800	
V5	AE BB405B 11/ 2PF CDI TUNING DIODE	AE 596.6839	PHILIPS-CO	BB405B	
V10	AK BFT66 N 15V 30MA TRANSISTOR	AK 252.5728	SIEMENS	BFT66	
V11	AD 1N4448 75V UDI DIODE	AD 012.0700	TEXAS INST	1N4448 GEGURTET	
V12	AK BCY59IX N 45V 200MA TRANSISTOR	AK 010.5163	PHILIPS-CO	BCY59IX	
V20	AD 1N4448 75V UDI DIODE	AD 012.0700	TEXAS INST	1N4448 GEGURTET	
V21	AD 1N4448 75V UDI DIODE	AD 012.0700	TEXAS INST	1N4448 GEGURTET	
V26	AK BCY59IX N 45V 200MA TRANSISTOR	AK 010.5163	PHILIPS-CO	BCY59IX	
V27	AE 5082-2800 SCHOTTKY DIODE	AE 012.9066	HEWLETT-P.	5082-2800	
V28	AE BZX55/B10 0,5W ZDI ZENER DIODE	AE 289.4302	PHILIPS-CO	BZX55/B10	
V29	AD 1N4448 75V UDI DIODE	AD 012.0700	TEXAS INST	1N4448 GEGURTET	
V30	AE BZX55/B10 0,5W ZDI ZENER DIODE	AE 289.4302	PHILIPS-CO	BZX55/B10	
V33	AD 1N4448 75V UDI DIODE	AD 012.0700	TEXAS INST	1N4448 GEGURTET	
V34	AK BCY59IX N 45V 200MA TRANSISTOR	AK 010.5163	PHILIPS-CO	BCY59IX	
V100	AE 5082-2800 SCHOTTKY DIODE	AE 012.9066	HEWLETT-P.	5082-2800	
V101	AK BFI N 15V 25MA TRANSISTOR	AK 010.4550	PHILIPS-CO	BFY90	
V102	AE 5082-2800 SCHOTTKY DIODE	AE 012.9066	HEWLETT-P.	5082-2800	
V103	AK BFY90 N 15V 25MA TRANSISTOR	AK 010.4550	PHILIPS-CO	BFY90	
V104	AK BFT66 N 15V 30MA TRANSISTOR	AK 252.5728	SIEMENS	BFT66	
V105	AE BB405B 11/ 2PF CDI TUNING DIODE	AE 596.6839	PHILIPS-CO	BB405B	

ROHDE & SCHWARZ	Äl	Datum Date	Schaltteilliste für Parts list for	Sachnummer Stock No.	Blatt Page
	36	1192	ED FSK MODEM	646.4727.01 SA	11+

Kennz. Comp.No.	Benennung Designation	Sachnummer Stock No.	Hersteller Manufacturer	Bezeichnung Designation	enthalten in contained in
V106	AE BB405B 11/ 2PF CDI TUNING DIODE	AE 596.6839	PHILIPS-CO	BB405B	
V107	AE BB405B 11/ 2PF CDI TUNING DIODE	AE 596.6839	PHILIPS-CO	BB405B	
V108	AE BB405B 11/ 2PF CDI TUNING DIODE	AE 596.6839	PHILIPS-CO	BB405B	
V200	AK BCY59IX N 45V 200MA TRANSISTOR	AK 010.5163	PHILIPS-CO	BCY59IX	
V201	AD 1N4448 75V UDI DIODE	AD 012.0700	TEXAS INST	1N4448 GEGURTET	
V202	AE 5082-2800 SCHOTTKY DIODE	AE 012.9066	HEWLETT-P.	5082-2800	
V203	AK BFY90 N 15V 25MA TRANSISTOR	AK 010.4550	PHILIPS-CO	BFY90	
V204	AE 5082-2800 SCHOTTKY DIODE	AE 012.9066	HEWLETT-P.	5082-2800	
V205	AD 1N4448 75V UDI DIODE	AD 012.0700	TEXAS INST	1N4448 GEGURTET	
V206	AK BFW16A N 40V 150MA TRANSISTOR	AK 010.4644	PHILIPS-CO	BFW16A	
V208	AE BZX79B3V9 2% 0.5W ZDI ZENER	AE 008.7685	PHILIPS	BZX79B3V9	
V209	AE BZX79B3V9 2% 0.5W ZDI ZENER	AE 008.7685	PHILIPS	BZX79B3V9	
V210	AD 1N4448 75V UDI DIODE	AD 012.0700	TEXAS INST	1N4448 GEGURTET	
V211	AK BCY59IX N 45V 200MA TRANSISTOR	AK 010.5163	PHILIPS-CO	BCY59IX	
V212	AE BZX79/B5V6 0,5W ZDI ZENER DIODE	AE 012.5254	PHILIPS-CO	BZX79/B5V6	
V213	AD 1N4448 75V UDI DIODE	AD 012.0700	TEXAS INST	1N4448 GEGURTET	
V215	AD 1N4448 75V UDI DIODE	AD 012.0700	TEXAS INST	1N4448 GEGURTET	
V216	AK 2N2905A P 60V 600MA TRANSISTOR	AK 010.3919	PHILIPS-CO	2N2905A	
V217	AK BCY79IX P 45V 200MA TRANSISTOR	AK 010.3777	PHILIPS-CO	BCY79IX	
V218	AE BZX79B3V9 2% 0.5W ZDI ZENER	AE 008.7685	PHILIPS	BZX79B3V9	
V219	AE BZX79B3V9 2% 0.5W ZDI ZENER	AE 008.7685	PHILIPS	BZX79B3V9	
W201	DW KABEL CABLE	646.5075			
X31	FP STECKERLEISTE 64POLIG 64-PIN INSERT	FP 084.6470	THOMAS&BET	161-66430-3008	
X32	FJ W.EINBAUST F.GS SMB PLUG	FJ 063.5180	SUHNER	85 SMB-50-0-1	
X33	FJ EINBAUSTECKER SYST.SMB FIXED CONNECTOR	FJ 063.5116	SUHNER	22SMB-50-0-2 ZU 100	
X101	FP STIFTLISTE 36P.R2,54 PIN CONNECTOR	FP 242.3600	BINDER	742-11-0179-00-36	
X102	FP KURZSCHLUSSBUCHSE SHORTING PLUG	FP 491.7042	PK	452-70302	
X201	FP STIFTLISTE 36P.R2,54 PIN CONNECTOR	FP 242.3600	BINDER	742-11-0179-00-36	
X202	FP KURZSCHLUSSBUCHSE SHORTING PLUG	FP 491.7042	PK	452-70302	

- ENDE -

ROHDE & SCHWARZ	Äl	Datum	Schaltteilliste für Parts list for	Sachnummer Stock No.	Blatt Page
		Date			
	36	1192	ED FSK MODEM	646.4727.01 SA	12-



ROHDE & SCHWARZ

Communications Division

Repair Manual

EMC FILTER

FK 852P7

680.2069

©

Copying of this document as well as any other utilization and communication of its content are only admissible with the permission of the originator or other authorized persons.

Any disregard will be prosecuted and is subject to restitution (UrhG, UWG, BGB). For the case a patent is issued or the design is officially registered all rights are reserved.

ROHDE & SCHWARZ GmbH & Co. KG · D-81671 München · Mühldorfstr. 15 · Tel. (089) 4129-0 Int. + 4989 4129-0

Telefax (089) 4129-2164 Int. + 4989 4129-2164

**Printed in the Federal Republic of Germany · Subject to change · Data without tolerances : order of magnitude only
0294**

E M C F I L T E R
F K 8 5 2 P 7

Repair Manual
 Part 0: List of Contents

- 0.1 -

L I S T O F C O N T E N T S

	Page
1. Characteristics (see User Manual) .	1.1
2. Preparation for Use and Operation (see User Manual) .	2.1
3. Maintenance (see User Manual) .	3.1
4. Troubleshooting (see User Manual) .	4.1
5. Description of Function	5.1
6. Repair	6.1
6.1 Preliminary Remarks	6.1
6.1.1 Troubleshooting Instructions	6.1
6.1.2 Restoring the Nominal Characteristics	6.1
6.1.3 Spare Parts	6.1
6.1.4 Important User Information	6.2
6.2 Test Equipment and Special Tools	6.3
6.2.1 List of Test Equipment	6.3
6.3 Troubleshooting Flowchart	6.3
6.3.1 General	6.3
6.4 Measurements and Functional Tests	6.6
6.4.1 Test of the Low-pass Filters for Continuity	6.6
6.4.2 Test of the Low-pass Filters for Short-circuit	6.6
6.4.3 Test of the AF Transformers	6.6
6.4.4 Test of the Filter Circuit	6.6
6.4.5 Test of the Logic Circuits	6.6

(Continuation)---

EMC FILTER
FK 852P7

Repair Manual
Part 0: List of Contents

- 0.2 -

---(Continuation) List of Contents

6.5	Replacement of the Module	6.6
6.5.1	Removal of the Rear Panel	6.7
6.5.2	Removal of the Printed Circuit Board	6.7
6.5.3	Assembly of the EMC Filter	6.7
6.6	Final Test	6.7
6.7	External Interfaces	6.8

LIST OF FIGURES

Fig.	Title	Page
5.1	EMC Filter FK 852P7, Block Diagram	5.3
6.1	Troubleshooting Flowchart	6.4
6.2	Removal of the EMC Filter	6.17

Appendix*****

Circuit Diagram, EMC Filter	680.2069.01S, page 1 + 2
Parts List, EMC Filter	680.2069.01SA
Components Layout, EMC Filter	680.2100.01, page 2 + 3

E M C F I L T E R
F K 8 5 2 P 7

Repair Manual
 Part 5: Description of Function

- 5.1 -

5. Description of Function

See circuit diagram 580.2069.01S, page 1 and 2 in the appendix to this manual and block diagram (Fig. 5.1).

The EMC Filter FK 852P7 prevents interfering signals of high frequency from entering the signal and control lines of the Receiver/Exciter GX 859C1. It also suppresses interfering frequencies generated by the processor of the Receiver/Exciter GX 859C1.

In addition the EMC filter filters the 28-VDC supply for the Receiver/Exciter GX 859C1.

The EMC Filter FK 852P7 consists of LC low-pass filters and LC filters in Pi-circuitry. Nine different types of filters are used whereby the threshold frequencies are matched to the relevant signal frequencies.

Data and control signals coming from the processor of the Receiver/Exciter GX 859C1 are buffered in the logic circuits. From there they are fed to the 1-kW Amplifier VK 859C1 or to the Power Supply IN 859C1 selectively and with low internal resistance.

The threshold frequencies are matched to the relevant signal frequencies.

The outputs to the power supply and to the 1-kW amplifier are routed via LC filters.

The data lines (D0 to D7) for the power supply are fed via 8-way registers. On the output side this results in a low resistance line impedance. Thereby a high stability against interfering signals is achieved.

If any failure message at one of the BITE lines such as BITE power supply, CM amplifier or BITE temperature is present for more than 5 ms the failure message "CM amplifier" is conducted to the processor.

The 28-VDC power supply from IN 859C1 for powering the Receiver/Exciter GX 859C1 and the Antenna Tuning Unit FK 859 or Line Flattener FK 859C1 is routed via fuses F1 and F2.

DC voltages of ± 16 VDC and +5.3 VDC are fed from the receiver/exciter's internal Power Supply IN 852P1 via fuses F3 to F5 to the power amplifier.

Transformers T1 to T4 are used for matching to symmetrical AF lines.

EMC FILTER
FK 852P7

Repair Manual
Part 5: Description of Function

NOTES

EMC FILTER
FK 852P7

Repair Manual
Part 6: Repair

- 6.1 -

6. Repair

See circuit diagram, parts list and components layout in the appendix to this repair manual (for listing see page 0.2).

6.1 Preliminary Remarks

The repair of the EMC Filter FK 852P7 comprises troubleshooting and fault elimination, measurements and functional tests, replacement of sub-assemblies and components, and a final test.

All the necessary information for the repair down to component level of the EMC filter are contained in this part 6.

6.1.1 Troubleshooting Instructions

Any fault that occurs should be localized with the aid of the systematical information given in 6.3 by checking the nominal values at the test points.

6.1.2 Restoring the Nominal Characteristics

Any component that is definitely proved to be defective - through use of the troubleshooting flowchart or by performing the alignments, measurements and functional tests - should only be replaced by a component that meets the specifications given in the parts list in the appendix to this repair manual.

Only in this way can the technical data be guaranteed that are given in part 1 of the user manual.

Once components have been replaced, it is absolutely essential that the final test detailed in part 6.6 is performed.

6.1.3 Spare Parts

All components and assemblies are subjected to strict quality assurance before they are allowed to be used in this item of equipment.

For components from outside suppliers, e.g. resistors, capacitors, diodes, transistors and integrated through to highly integrated circuits, R&S have set down their own delivery specifications for the purpose of ensuring maximum reliability.

For this reason we recommend that only original spare parts are used, for replacing defective components.

When ordering a spare part, please state the following:

Type, ordering code and serial number of equipment, stock number of the parts list and designation plus stock number of the component concerned.

All of these details are to be found in the circuit diagram, parts list and components layout that accompany the manual.

EMC FILTER
FK 852P7

Repair Manual
Part 6: Repair

- 6.2 -

6.1.4 Important User Information

Please note the following points, which are important for the avoidance of misunderstandings when using part 6 of the repair manual:

- o All measurements are referred to ground unless otherwise stated.
- o All components mentioned in the following text and figures are contained in circuit diagram 680.2069.01S, page 1 and 2. Special reference will therefore not be made to this diagram in the following text, but only to the relevant page.
- o Perform all measurements and alignments with the correct operating voltages connected, as indicated in the circuit diagram.
- o Before performing any soldering work on the equipment or an assembly, switch off the operating voltages.

C A U T I O N C M O S

- o Among the components incorporated in the power supply there are MOS, MOSFET and CMOS devices. Devices of this kind are extremely sensitive to high extraneous voltages. Static discharge can produce very high voltage spikes, which are capable of destroying these devices. Electrostatic charges are felt only if they exceed 3000 V.

However, less than 10% of these values are capable of destroying semiconductors or degrade their parameters: e.g. bipolar transistors (400 V), ECL and Schottky (300 V), VMOS and CMOS (150 V), MOSFETs (100 to 200 V). A person sitting at a working table already produces about 500 V static charge.

For this reason, when work is being carried out in the vicinity of these devices, i.e. unless a special CMOS work station is available, the following minimum requirements should be observed:

- o Conductive bench and floor coverings
- o Chair or stool with conductive coverings
- o Grounded, metallic work surfaces, and conductive wrist-straps with a resistance of $> 200 \text{ kohms} < 1 \text{ Mohm}$ plus an insulated lead and plug
- o Soldering iron with safety grounding
- o All conductive surfaces, wrist-straps and work surfaces must be interconnected by insulated leads
- o Supply voltages must be disconnected when soldering is being performed.

EMC FILTER
FK 852P7

Repair Manual
Part 6: Repair

- 6.3 -

6.2 Test Equipment and Special Tools

The test equipment given in the following list will be required for performing the repairs described in this part of the manual.

Equivalent items of test equipment can be used, of course, provided that their data are at least as good. Special tools are not required.

6.2.1 List of Test Equipment

Test equipment, required data	Recommended R&S equipment	Order no.
Digital multimeter resistance measurement range 10 mohms to 20 Mohms	UDL 33	388.8011.02

6.3 Troubleshooting Flowchart

The troubleshooting is based upon the following assumptions:

- o The EMC filter has been clearly identified as being defect.
- o The operational voltages are present.

chart Fig. 6.1 comprises the troubleshooting as well as the elimination of faults in the EMC Filter FK 852P7.

To make the troubleshooting flowchart clearer and more understandable, cross references to other measurements and repair work are given where necessary. To enable the troubleshooting and repair work to take place rationally and speedily, the order of the tests should be followed as presented here.

6.3.1 General

The following troubleshooting flow-

EMC FILTER
FK 852P7

Repair Manual
Part 6: Repair

- 6.4 -

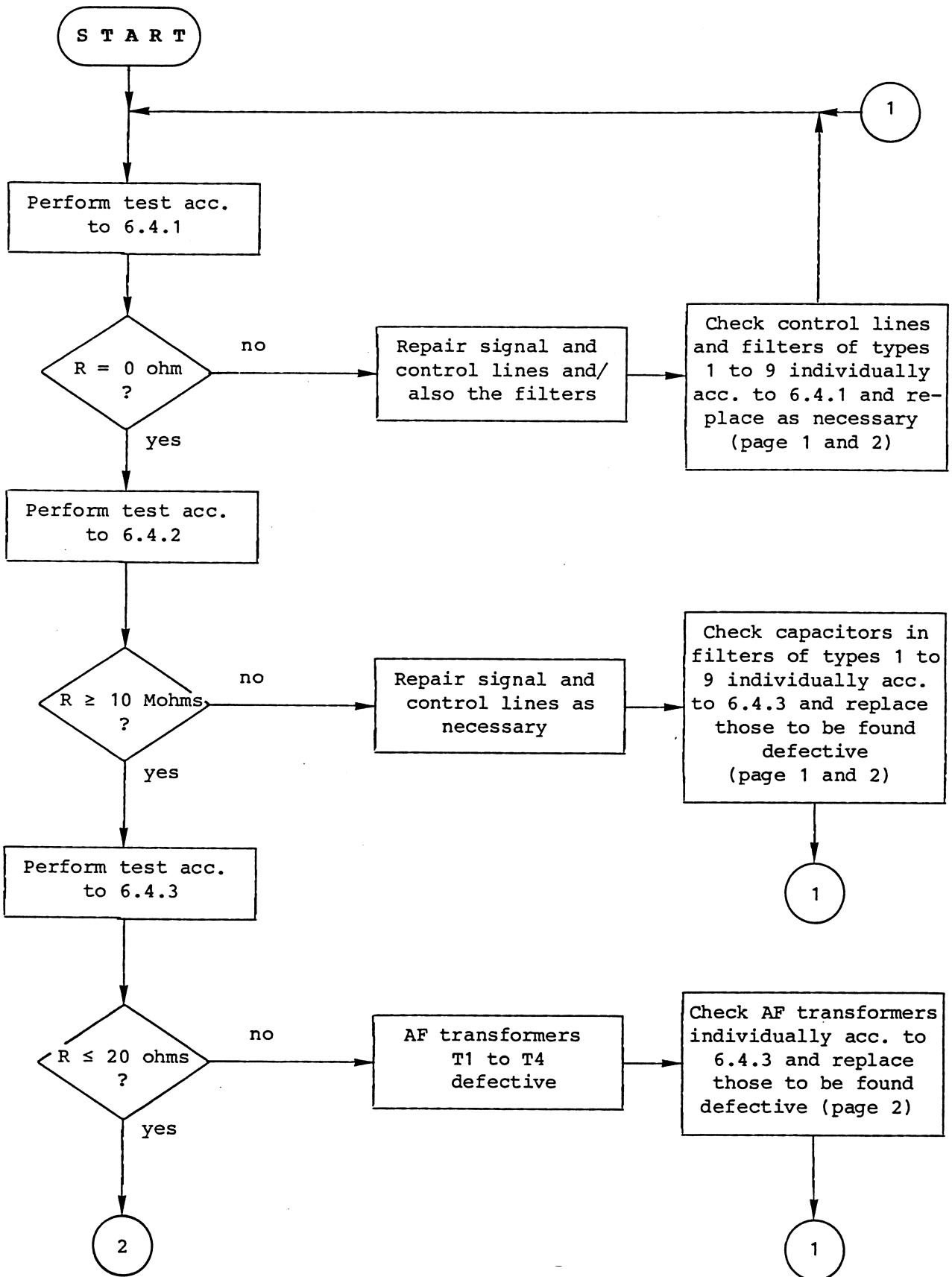

Fig. 6.1 Troubleshooting Flowchart (page 1 of 2)

EMC FILTER
FK 852P7

Repair Manual
Part 6: Repair

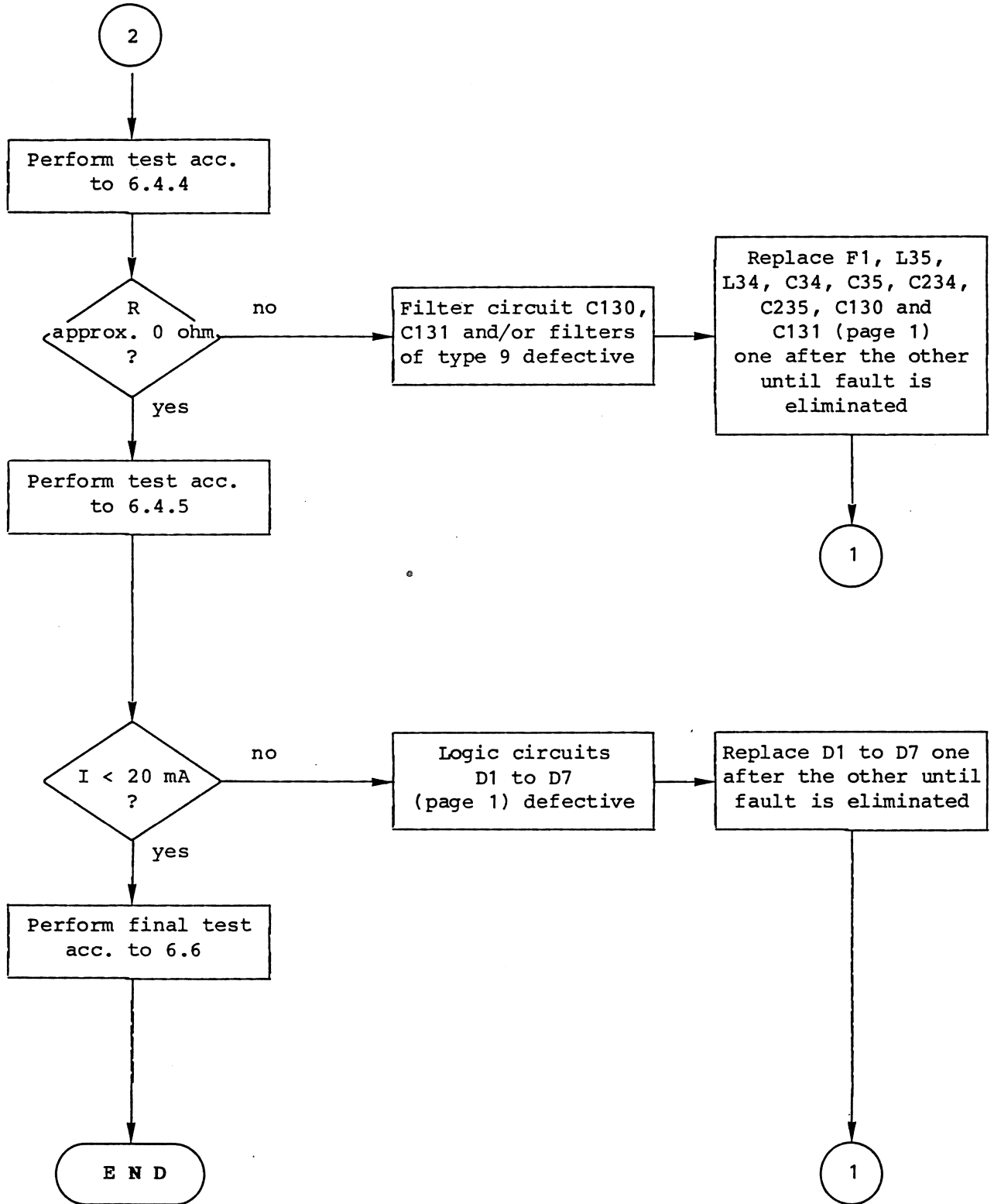

Fig. 6.1 Troubleshooting Flowchart (page 2 of 2)

EMC FILTER
FK 852P7

Repair Manual
Part 6: Repair

- 6.6 -

6.4 Measurements and Functional Tests

The measurements and functional tests that are described below are the more detailed procedures to the instructions given in a condensed form in the troubleshooting flowchart. Consequently one will usually undertake these measurements and functional tests by branching out of the troubleshooting flowchart at a particular point. When the measurement, etc. has been performed, one returns to the troubleshooting flowchart at the same point where one previously left it.

If a fault has been clearly identified beforehand however, one can of course commence with one of these measurements directly.

6.4.1 Test of the Low-pass Filters for Continuity

Test all signal and control lines with a digital multimeter for continuity between input (X60, X61, X71 and X72) and output (X2 to X6) with the exception of the data and AF lines.

6.4.2 Test of the Low-pass Filters for Short-circuit

Test the signal and control lines with a digital multimeter for short-circuit to ground.

6.4.3 Test of the AF Transformers

Check the primary and the secondary windings of the transformers T1 to T4 with a digital multimeter.

6.4.4 Test of the Filter Circuit

1. Check the resistance between plug X6, contact 4/5 and plug X71, contact b9/b10, using a digital multimeter.
2. Check the resistance between plug X6, contact 1/2/3 and plug X71, contact a9/a10, using a digital multimeter.

6.4.5 Test of the Logic Circuits

Connect +5.3 VDC to connector X5, contact 13, and ground to contact 11/12/30. At plug X61.ab14 check the current consumption of the logic circuits, using a digital multimeter.

Nominal value: ≤ 20 mA

6.5 Replacement of the Module

CAUTION

Before removing the module from the receiver/exciter, the power supply to the receiver/exciter must be disconnected.

Note:

Pull the receiver/exciter out of the rack and place upright. Then proceed as follows:

1. Undo four screws (22, Fig. 6.1).
2. Slightly lift the EMC filter. Using the levers provided at the connector strips (2 and 4, Fig. 6.1), loosen the 64-way and the 20-way ribbon cable.
3. Loosen two ribbon cables (6 and 7, Fig. 6.1) on the counter assemblies and take out the EMC filter to the rear.

EMC FILTER
FK 852P7

Repair Manual
Part 6: Repair

- 6.7 -

6.5.1 Removal of the Rear Panel

Undo 17 screws (14 and 16, Fig. 6.1). Take off the rear panel (8) from the printed circuit board (5).

6.5.3 Assembly of the EMC Filter

The re-assembly of the EMC filter is done in the reverse order of the removal.

6.5.2 Removal of the Printed Circuit Board

1. Remove the rear panel acc. to 6.5.1 and take off the printed circuit board (5, Fig. 6.1). The replacement of components follows normal workshop practice. No special instructions are necessary.

2. Unscrew nut (7, Fig. 6.1) and replace defective RF cable (11, 12 and 13), as required.

6.6 Final Test

For the EMC Filter FK 852P7 no separate final test is required.

After successful repair perform a functional test of the EMC filter together with the receiver/exciter.

EMC FILTER
FK 852P7

Repair Manual
Part 6: Repair

- 6.8 -

6.7 External Interfaces

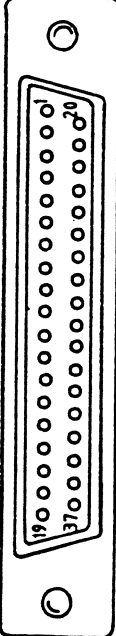
<u>External Interfaces</u>		
X2 REMOTE control	Contact	Signal designation/level
	1	Ground
	2	Ground
	3	-5 VDC
	4	+7.25 VDC
	5	not used
	6	not used
	7	E2 ground
	8	D1
	9	TTY demod. remote
	10	TTY mod. remote
	11	S1.2
	12	M2
	13	D2
	14	AF mod. a
	15	AF mod. b
	16	AF demod. b
	17	AF demod. a
	18	Spare
	19	TTY ground
	20	Ground
	21	-16 VDC
	22	+16 VDC
	23	+7.25 VDC
	24	not used
	25	not used
	26	Spare
	27	S2
	28	Carrier switching remote
	29	D1
	30	T
	31	M1
	32	D2
	33	ON remote a
	34	ON a
	35	ON remote b
	36	ON b
	37	not used

(Continuation)---

EMC FILTER
FK 852P7

Repair Manual
Part 6: Repair

- 6.9 -

---(Continuation) External Interfaces

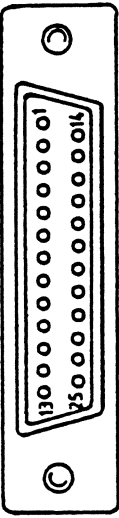
<u>External Interfaces</u>		
X3 APG ATU	Contact	Signal designation/level
25-way female connector strip FM, WRAP 	1	0V
	2	+24VDC
	3	Ground
	4	not used
	5	not used
	6	BITE ATU3
	7	Tuning (signal inverted)
	8	STROBE
	9	not used
	10	ATU ON
	11	Tuning pulse (signal inverted)
	12	Transmit
	13	CM ATU
	14	+24VDC
	15	0V
	16	not used
	17	not used
	18	Carrier inhibit
	19	BITE ATU2
	20	BITE ATU1
	21	Data (TTL)
	22	not used
	23	Spare
	24	Shift clock
	25	Frequency inhibit

(Continuation)---

EMC FILTER
FK 852P7

Repair Manual
Part 6: Repair

- 6.10 -

---(Continuation) External Interfaces

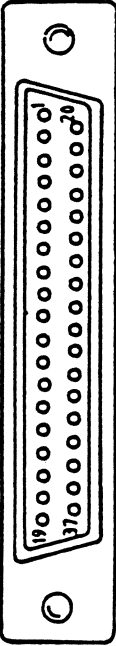
<u>External Interfaces</u>		
X4 EXTERN	Contact	Signal designation/level
	1	<u>Loudspeaker ground</u>
	2	CM ext.
	3	EXT. 4
	4	<u>EXT. 2</u>
	5	Silence
	6	Soft decision b
	7	<u>IF AGC</u>
	8	Transmit
	9	TTY ground V.28
	10	TTY transmit V.28
	11	TTY transmit a
	12	AF transmit a
	13	AF receive b
	14	<u>TTY receive b</u>
	15	Rx blocking
	16	Transmit
	17	not used
	18	not used
	19	Ground
	20	Loudspeaker
	21	Spare
	22	EXT. 3
	23	EXT. 1
	24	Soft decision c
	25	Soft decision a
	26	<u>Squelch</u>
	27	F1 transmit
	28	TTY receive V.28
	29	TTY receive a
	30	TTY transmit b
	31	AF transmit b
	32	AF receive a
	33	Test trigger external
	34	CM/BITE NO GO
	35	not used
	36	not used
	37	Ground

(Continuation)---

EMC FILTER
FK 852P7

Repair Manual
Part 6: Repair

- 6.11 -

---(Continuation) External Interfaces

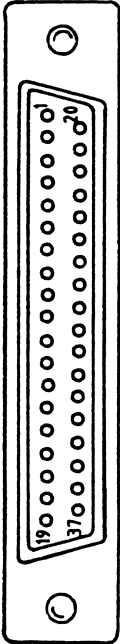
<u>External Interfaces</u>		
X5 AMPLIFIER	Contact	Signal designation/level
37-way female connector strip FM, WRAP 	1	BITE final stage 2
	2	D0
	3	D2
	4	D4
	5	D6
	6	BITE temperature
	7	Carrier inhibit
	8	CM amplifier
	9	TEST
	10	Transmit
	11	Ground
	12	Ground
	13	+5.3 VDC
	14	not used
	15	not used
	16	not used
	17	not used
	18	not used
	19	not used
	20	BITE final stage 1
	21	D1
	22	D3
	23	D5
	24	D7
	25	STROBE 5
	26	CM RF
	27	BITE amplifier
	28	CM VSWR
	29	-16 VDC
	30	Ground
	31	+16 VDC
	32	not used
	33	not used
	34	not used
	35	not used
	36	not used
	37	not used

(Continuation)---

EMC FILTER
FK 852P7

Repair Manual
Part 6: Repair

- 6.12 -

---(Continuation) External Interfaces

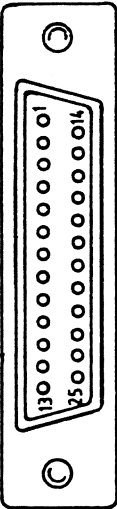
<u>External Interfaces</u>		
X6 POWER SUPPLY	Contact	Signal designation/level
25-way male connector strip FM, WRAP 	1	0 V
	2	0 V
	3	0 V
	4	+28 VDC
	5	+28 VDC
	6	Ground
	7	Ground
	8	BITE power supply unit
	9	not used
	10	D6
	11	D4
	12	D2
	13	D0
	14	Ground
	15	Ground
	16	+28 VDC
	17	+28 VDC
	18	not used
	19	Ground
	20	not used
	21	not used
	22	D7
	23	D5
	24	D3
	25	D1

(Continuation)---

EMC FILTER
FK 852P7

Repair Manual
Part 6: Repair

- 6.13 -

---(Continuation) External Interfaces

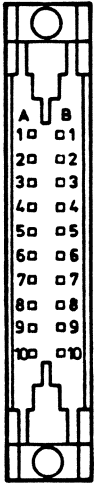
<u>External Interfaces</u>		
X71	Contact	Signal designation/level
20-way male connector strip FP, WINK 	a1 a2 a3 a4 a5 a6 a7 a8 a9 a10 b1 b2 b3 b4 b5 b6 b7 b8 b9 b10	+7.25 VDC -16 VDC -5 VDC 0 V 0 V S2 Carrier activation, remote Spare 0 V 0 V +7.25 VDC +16 VDC Ground +28 VDC +28 VDC TTY demod. remote D1 not used +28 VDC +28 VDC
X72	Contact	Signal designation/level
64-way male connector strip FP, WINK	a1 a2 a3 a4 a5 a6 a7 a8 a9 a10 a11 a12 a13 a14 a15 a16 a17 a18 a19 a20 a21 a22 a23	TTY mod. remote D1 M2 D2 ON a ON b TTY ground Spare AF demod. a Spare Tuning pulse Shift clock Tuning AF mod. a Carrier inhibit Frequency inhibit AF receive b CM/BITE NO GO Test triggering, external TTY transmit a TTY receive a TTY receive V.28 F1 transmit

(Continuation)---

EMC FILTER
FK 852P7

Repair Manual
Part 6: Repair

- 6.14 -

---(Continuation) External Interfaces

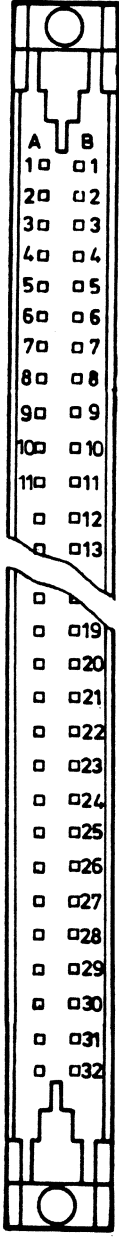
External Interfaces		
X72 cont.	Contact	Signal designation/level
	a24	AF transmit a
	a25	Squelch
	a26	Soft decision a
	a27	Soft decision c
	a28	EXT. 1
	a29	EXT. 3
	a30	Spare
	a31	Loudspeaker ground
	a32	Ground
	b1	S1.2
	b2	T
	b3	M1
	b4	D2
	b5	ON remote a
	b6	ON remote b
	b7	AF demod. b
	b8	ATU ON
	b9	Data
	b10	Strobe
	b11	AF mod. b
	b12	BITE ATU 1
	b13	BITE ATU 2
	b14	BITE ATU 3
	b15	Transmit
	b16	CM ATU
	b17	AF receive a
	b18	Rx blocking
	b19	TTY receive b
	b20	TTY transmit b
	b21	TTY transmit V.28
	b22	TTY ground V.28
	b23	Transmit
b24	AF transmit b	
b25	AGC IF	
b26	Soft decision b	
b27	Silence	
b28	EXT. 2	
b29	EXT. 4	
b30	CM EXT.	
b31	Loudspeaker	
b32	Ground	

(Continuation)---

EMC FILTER
FK 852P7

Repair Manual
Part 6: Repair

- 6.15 -

---(Continuation) External Interfaces

External Interfaces																																						
W73 X60	Contact	Signal designation/level																																				
Ribbon cable DX 10-way <table border="1" style="margin-left: 40px;"> <tr><td>A</td><td>B</td></tr> <tr><td>10</td><td>01</td></tr> <tr><td>20</td><td>02</td></tr> <tr><td>30</td><td>03</td></tr> <tr><td>40</td><td>04</td></tr> <tr><td>50</td><td>05</td></tr> </table>	A	B	10	01	20	02	30	03	40	04	50	05	A1 A2 A3 A4 A5 B1 B2 B3 B4 B5	0 V (ground) BITE temperature BITE final stage 1 BITE final stage 2 BITE power supply not used not used not used not used Strobe 13																								
A	B																																					
10	01																																					
20	02																																					
30	03																																					
40	04																																					
50	05																																					
W74 X61	Contact	Signal designation/level																																				
Ribbon cable DX 34-way <table border="1" style="margin-left: 40px;"> <tr><td>A</td><td>B</td></tr> <tr><td>10</td><td>02</td></tr> <tr><td>20</td><td>02</td></tr> <tr><td>30</td><td>03</td></tr> <tr><td>40</td><td>04</td></tr> <tr><td>50</td><td>05</td></tr> <tr><td>60</td><td>06</td></tr> <tr><td>70</td><td>07</td></tr> <tr><td>80</td><td>08</td></tr> <tr><td>90</td><td>09</td></tr> <tr><td>100</td><td>010</td></tr> <tr><td>110</td><td>011</td></tr> <tr><td>120</td><td>012</td></tr> <tr><td>130</td><td>013</td></tr> <tr><td>140</td><td>014</td></tr> <tr><td>150</td><td>015</td></tr> <tr><td>160</td><td>016</td></tr> <tr><td>170</td><td>017</td></tr> </table>	A	B	10	02	20	02	30	03	40	04	50	05	60	06	70	07	80	08	90	09	100	010	110	011	120	012	130	013	140	014	150	015	160	016	170	017	A1 A2 A3 A4 A5 A6 A7 A8 A9 A10 A11 A12 A13 A14 A15 A16 A17 B1 B2 B3 B4 B5 B6 B7 B8 B9 B10 B11 B12 B13 B14 B15 B16 B17	not used not used D1 D3 D5 D7 Carrier inhibit CM RF BITE amplifier Strobe 9 not used not used -16 VDC +5.3 VDC not used +16 VDC 0 V (ground) not used CM VSWR D0 D2 D4 D6 Strobe 5 Transmit CM amplifier not used not used not used -16 VDC +5.3 VDC not used +16 VDC 0 V (ground)
A	B																																					
10	02																																					
20	02																																					
30	03																																					
40	04																																					
50	05																																					
60	06																																					
70	07																																					
80	08																																					
90	09																																					
100	010																																					
110	011																																					
120	012																																					
130	013																																					
140	014																																					
150	015																																					
160	016																																					
170	017																																					

EMC FILTER
FK 852P7

Repair Manual
Part 6: Repair

NOTES



ROHDE & SCHWARZ

Communications Division

Appendix

CIRCUIT DIAGRAMS

PARTS LISTS

COMPONENTS LAYOUTS

Für diese Unterlage behalten wir uns alle Rechte vor

Kennz. Comp.No	Benennung Designation	Sachnummer Stock No.	Hersteller Manufacturer	Bezeichnung Designation	enthalten in contained in
	VARIANTENERKL. / VERSIONS VAR 02 = RAL 7011 VAR 03 = RAL 6014 VAR 04 = RAL 7001				
A1	ED FILTER HIERZ. STROML. 680.2069.01 S	680.2100.02			
C9	CC 100NF+-10%50V5K1200VIE CAPACITOR	CC 084.5350	UNION CARB	CK05BX104K	680.2100.01
C10	CC 100NF+-10%50V5K1200VIE CAPACITOR	CC 084.5350	UNION CARB	CK05BX104K	680.2100.01
C11	CC 100NF+-10%50V5K1200VIE CAPACITOR	CC 084.5350	UNION CARB	CK05BX104K	680.2100.01
C20	CC 100NF+-10%50V5K1200VIE CAPACITOR	CC 084.5350	UNION CARB	CK05BX104K	680.2100.01
C22	CC 100NF+-10%50V5K1200VIE CAPACITOR	CC 084.5350	UNION CARB	CK05BX104K	680.2100.01
C23	CC 100NF+-10%50V5K1200VIE CAPACITOR	CC 084.5350	UNION CARB	CK05BX104K	680.2100.01
C24	CC 100NF+-10%50V5K1200VIE CAPACITOR	CC 084.5350	UNION CARB	CK05BX104K	680.2100.01
C25	CC 100NF+-10%50V5K1200VIE CAPACITOR	CC 084.5350	UNION CARB	CK05BX104K	680.2100.01
C27	CC 100NF+-10%50V5K1200VIE CAPACITOR	CC 084.5350	UNION CARB	CK05BX104K	680.2100.01
C29	CC 10NF+-10%100V5K1200VIE CERAMIC CAPACITOR	CC 068.4060	UNION CARB	CK05BX103K	680.2100.01
C30 ..38	CK 1UF+-10%50V5RM MKT CAPACITOR	CK 099.2998	WIMA	MKS2/50/1UF/10%	680.2100.01
C39	CC 100NF+-10%50V5K1200VIE CAPACITOR	CC 084.5350	UNION CARB	CK05BX104K	680.2100.01
C40	CC 100NF+-10%50V5K1200VIE CAPACITOR	CC 084.5350	UNION CARB	CK05BX104K	680.2100.01
C41	CC 100NF+-10%50V5K1200VIE CAPACITOR	CC 084.5350	UNION CARB	CK05BX104K	680.2100.01
C42	CC 100NF+-10%50V5K1200VIE CAPACITOR	CC 084.5350	UNION CARB	CK05BX104K	680.2100.01
C43	CC 100NF+-10%50V5K1200VIE CAPACITOR	CC 084.5350	UNION CARB	CK05BX104K	680.2100.01
C44	CC 100NF+-10%50V5K1200VIE CAPACITOR	CC 084.5350	UNION CARB	CK05BX104K	680.2100.01
C45	CC 10NF+-10%100V5K1200VIE CERAMIC CAPACITOR	CC 068.4060	UNION CARB	CK05BX103K	680.2100.01
C46	CC 100NF+-10%50V5K1200VIE CAPACITOR	CC 084.5350	UNION CARB	CK05BX104K	680.2100.01
C47	CC 100NF+-10%50V5K1200VIE CAPACITOR	CC 084.5350	UNION CARB	CK05BX104K	680.2100.01
C48	CC 100NF+-10%50V5K1200VIE CAPACITOR	CC 084.5350	UNION CARB	CK05BX104K	680.2100.01
C49	CC 100NF+-10%50V5K1200VIE CAPACITOR	CC 084.5350	UNION CARB	CK05BX104K	680.2100.01
C50	CC 10NF+-10%100V5K1200VIE CERAMIC CAPACITOR	CC 068.4060	UNION CARB	CK05BX103K	680.2100.01
C51	CC 100NF+-10%50V5K1200VIE CAPACITOR	CC 084.5350	UNION CARB	CK05BX104K	680.2100.01
C52	CC 10NF+-10%100V5K1200VIE CERAMIC CAPACITOR	CC 068.4060	UNION CARB	CK05BX103K	680.2100.01
C53	CC 100NF+-10%50V5K1200VIE CAPACITOR	CC 084.5350	UNION CARB	CK05BX104K	680.2100.01
C66	CC 100NF+-10%50V5K1200VIE CAPACITOR	CC 084.5350	UNION CARB	CK05BX104K	680.2100.01
C67	CC 100NF+-10%100V K1200VI CERAMIC CAPACITOR	060.1149	UNION CARB	CK06BX104K	680.2100.01
C68	CC 100NF+-10%50V5K1200VIE CAPACITOR	CC 084.5350	UNION CARB	CK05BX104K	680.2100.01
C69	CC 100NF+-10%100V K1200VI CERAMIC CAPACITOR	060.1149	UNION CARB	CK06BX104K	680.2100.01
C70	CC 100NF+-10%50V5K1200VIE CAPACITOR	CC 084.5350	UNION CARB	CK05BX104K	680.2100.01
C71	CC 10NF+-10%100V5K1200VIE CERAMIC CAPACITOR	CC 068.4060	UNION CARB	CK05BX103K	680.2100.01
C72	CC 1UF+-10%50V7K1200VIEL CAPACITOR	084.5538	UNION CARB	CK06BX105K	680.2100.01
C73	CC 100NF+-10%50V5K1200VIE CAPACITOR	CC 084.5350	UNION CARB	CK05BX104K	680.2100.01
C74	CC 10NF+-10%100V5K1200VIE CERAMIC CAPACITOR	CC 068.4060	UNION CARB	CK05BX103K	680.2100.01

ROHDE & SCHWARZ	Al	Datum Date	Schaltteilliste für Parts list for	Sachnummer Stock Nr.	Blatt Page
	17	1289	FK852P7 EMC-FILTER	680.2069.01 SA	1+

Für diese Unterlage behalten wir
uns alle Rechte vor

Kennz. Comp.No.	Benennung Designation	Sachnummer Stock No.	Hersteller Manufacturer	Bezeichnung Designation	enthalten in contained in
C75	CC 10NF+-10%100V5K1200VIE CERAMIC CAPACITOR	CC 068.4060	UNION CARB	CK05BX103K	680.2100.01
C76	CC 10NF+-10%100V5K1200VIE CERAMIC CAPACITOR	CC 068.4060	UNION CARB	CK05BX103K	680.2100.01
C77	CC 10NF+-10%100V5K1200VIE CERAMIC CAPACITOR	CC 068.4060	UNION CARB	CK05BX103K	680.2100.01
C78	CC 10NF+-10%100V5K1200VIE CERAMIC CAPACITOR	CC 068.4060	UNION CARB	CK05BX103K	680.2100.01
C79	CC 10NF+-10%100V5K1200VIE CERAMIC CAPACITOR	CC 068.4060	UNION CARB	CK05BX103K	680.2100.01
C80	CC 10NF+-10%100V5K1200VIE CERAMIC CAPACITOR	CC 068.4060	UNION CARB	CK05BX103K	680.2100.01
C81	CC 100NF+-10%50V5K1200VIE CAPACITOR	CC 084.5350	UNION CARB	CK05BX104K	680.2100.01
C82	CC 10NF+-10%100V5K1200VIE CERAMIC CAPACITOR	CC 068.4060	UNION CARB	CK05BX103K	680.2100.01
C83	CC 100NF+-10%50V5K1200VIE CAPACITOR	CC 084.5350	UNION CARB	CK05BX104K	680.2100.01
C84	CC 100NF+-10%100V K1200VI CERAMIC CAPACITOR	060.1149	UNION CARB	CK06BX104K	680.2100.01
C85	CC 1UF+-10%50V7K1200VIEL CAPACITOR	084.5538	UNION CARB	CK06BX105K	680.2100.01
C86	CC 100NF+-10%100V K1200VI CERAMIC CAPACITOR	060.1149	UNION CARB	CK06BX104K	680.2100.01
C87	CC 100NF+-10%100V K1200VI CERAMIC CAPACITOR	060.1149	UNION CARB	CK06BX104K	680.2100.01
C88	CC 100NF+-10%100V K1200VI CERAMIC CAPACITOR	060.1149	UNION CARB	CK06BX104K	680.2100.01
C89	CC 100NF+-10%50V5K1200VIE CAPACITOR	CC 084.5350	UNION CARB	CK05BX104K	680.2100.01
C90	CC 100NF+-10%50V5K1200VIE CAPACITOR	CC 084.5350	UNION CARB	CK05BX104K	680.2100.01
C91	CC 100NF+-10%50V5K1200VIE CAPACITOR	CC 084.5350	UNION CARB	CK05BX104K	680.2100.01
C92	CC 100NF+-10%50V5K1200VIE CAPACITOR	CC 084.5350	UNION CARB	CK05BX104K	680.2100.01
C93	CC 100NF+-10%50V5K1200VIE CAPACITOR	CC 084.5350	UNION CARB	CK05BX104K	680.2100.01
C94	CC 100NF+-10%50V5K1200VIE CAPACITOR	CC 084.5350	UNION CARB	CK05BX104K	680.2100.01
C95	CC 100NF+-10%50V5K1200VIE CAPACITOR	CC 084.5350	UNION CARB	CK05BX104K	680.2100.01
C96	CC 100NF+-10%50V5K1200VIE CAPACITOR	CC 084.5350	UNION CARB	CK05BX104K	680.2100.01
C97	CC 100NF+-10%50V5K1200VIE CAPACITOR	CC 084.5350	UNION CARB	CK05BX104K	680.2100.01
C99	CC 100NF+-10%50V5K1200VIE CAPACITOR	CC 084.5350	UNION CARB	CK05BX104K	680.2100.01
C100	CC 100NF+-10%50V5K1200VIE CAPACITOR	CC 084.5350	UNION CARB	CK05BX104K	680.2100.01
C101	CC 100NF+-10%50V5K1200VIE CAPACITOR	CC 084.5350	UNION CARB	CK05BX104K	680.2100.01
C102	CC 100NF+-10%50V5K1200VIE CAPACITOR	CC 084.5350	UNION CARB	CK05BX104K	680.2100.01
C103	CC 100NF+-10%50V5K1200VIE CAPACITOR	CC 084.5350	UNION CARB	CK05BX104K	680.2100.01
C104	CC 100NF+-10%50V5K1200VIE CAPACITOR	CC 084.5350	UNION CARB	CK05BX104K	680.2100.01
C105	CC 100NF+-10%50V5K1200VIE CAPACITOR	CC 084.5350	UNION CARB	CK05BX104K	680.2100.01
C106	CC 10NF+-10%100V5K1200VIE CERAMIC CAPACITOR	CC 068.4060	UNION CARB	CK05BX103K	680.2100.01
C107	CC 10NF+-10%100V5K1200VIE CERAMIC CAPACITOR	CC 068.4060	UNION CARB	CK05BX103K	680.2100.01
C108	CC 100PF+- 5%100V NPD VIE CERAMIC CAPACITOR	CC 060.0771	UNIONCARB	C052C101J2G1CA	680.2100.01
C109	CC 100PF+- 5%100V NPD VIE CERAMIC CAPACITOR	CC 060.0771	UNIONCARB	C052C101J2G1CA	680.2100.01
C110	CC 100PF+- 5%100V NPD VIE CERAMIC CAPACITOR	CC 060.0771	UNIONCARB	C052C101J2G1CA	680.2100.01
C111	CC 100PF+- 5%100V NPD VIE CERAMIC CAPACITOR	CC 060.0771	UNIONCARB	C052C101J2G1CA	680.2100.01
C112	CC 100PF+- 5%100V NPD VIE CERAMIC CAPACITOR	CC 060.0771	UNIONCARB	C052C101J2G1CA	680.2100.01
C113	CC 100PF+- 5%100V NPD VIE CERAMIC CAPACITOR	CC 060.0771	UNIONCARB	C052C101J2G1CA	680.2100.01
C114	CC 100PF+- 5%100V NPD VIE CERAMIC CAPACITOR	CC 060.0771	UNIONCARB	C052C101J2G1CA	680.2100.01

ROHDE & SCHWARZ

AI Datum
Date
17.12.89

Schaltteilliste für
Parts list for

FK852P7 EMC-FILTER

Sachnummer
Stock Nr.

680.2069.01 SA

Blatt
Page

2+

Für diese Unterlage behalten wir uns alle Rechte vor

Kennz. Comp.No.	Benennung Designation	Sachnummer Stock No.	Hersteller Manufacturer	Bezeichnung Designation	enthalten in contained in
C115	CC 100PF+- 5%100V NPO VIE CERAMIC CAPACITOR	CC 060.0771	UNIONCARB	C052C101J2G1CA	680.2100.01
C116	CC 100PF+- 5%100V NPO VIE CERAMIC CAPACITOR	CC 060.0771	UNIONCARB	C052C101J2G1CA	680.2100.01
C117	CC 100PF+- 5%100V NPO VIE CERAMIC CAPACITOR	CC 060.0771	UNIONCARB	C052C101J2G1CA	680.2100.01
C118	CC 100NF+-10%50V5K1200VIE CAPACITOR	CC 084.5350	UNION CARB	CK05BX104K	680.2100.01
C119	CC 100NF+-10%50V5K1200VIE CAPACITOR	CC 084.5350	UNION CARB	CK05BX104K	680.2100.01
C130	CK 1UF+-10%50V5RM MKT CAPACITOR	CK 099.2998	WIMA	MKS2/50/1UF/10%	680.2100.01
C131	CE 10000UF-10+50%40V35X50 ELECTROLYTIC CAPACITOR	300.6401	ROEDERST	EYV00CD510G01	680.2100.01
C201	CC 100NF+-10%50V5K1200VIE CAPACITOR	CC 084.5350	UNION CARB	CK05BX104K	680.2100.01
C202	CC 100NF+-10%50V5K1200VIE CAPACITOR	CC 084.5350	UNION CARB	CK05BX104K	680.2100.01
C203	CC 100NF+-10%50V5K1200VIE CAPACITOR	CC 084.5350	UNION CARB	CK05BX104K	680.2100.01
C204	CC 100NF+-10%50V5K1200VIE CAPACITOR	CC 084.5350	UNION CARB	CK05BX104K	680.2100.01
C205	CC 100NF+-10%50V5K1200VIE CAPACITOR	CC 084.5350	UNION CARB	CK05BX104K	680.2100.01
C206	CC 100NF+-10%50V5K1200VIE CAPACITOR	CC 084.5350	UNION CARB	CK05BX104K	680.2100.01
C207	CC 100NF+-10%50V5K1200VIE CAPACITOR	CC 084.5350	UNION CARB	CK05BX104K	680.2100.01
C208	CC 100NF+-10%50V5K1200VIE CAPACITOR	CC 084.5350	UNION CARB	CK05BX104K	680.2100.01
C209	CC 100NF+-10%50V5K1200VIE CAPACITOR	CC 084.5350	UNION CARB	CK05BX104K	680.2100.01
C210	CC 100NF+-10%50V5K1200VIE CAPACITOR	CC 084.5350	UNION CARB	CK05BX104K	680.2100.01
C211	CC 100NF+-10%50V5K1200VIE CAPACITOR	CC 084.5350	UNION CARB	CK05BX104K	680.2100.01
C212	CC 100NF+-10%50V5K1200VIE CAPACITOR	CC 084.5350	UNION CARB	CK05BX104K	680.2100.01
C213	CC 100NF+-10%50V5K1200VIE CAPACITOR	CC 084.5350	UNION CARB	CK05BX104K	680.2100.01
C214	CC 100NF+-10%50V5K1200VIE CAPACITOR	CC 084.5350	UNION CARB	CK05BX104K	680.2100.01
C215	CC 100NF+-10%50V5K1200VIE CAPACITOR	CC 084.5350	UNION CARB	CK05BX104K	680.2100.01
C216	CC 100NF+-10%50V5K1200VIE CAPACITOR	CC 084.5350	UNION CARB	CK05BX104K	680.2100.01
C217	CC 100NF+-10%50V5K1200VIE CAPACITOR	CC 084.5350	UNION CARB	CK05BX104K	680.2100.01
C218	CC 100NF+-10%50V5K1200VIE CAPACITOR	CC 084.5350	UNION CARB	CK05BX104K	680.2100.01
C219	CC 100NF+-10%50V5K1200VIE CAPACITOR	CC 084.5350	UNION CARB	CK05BX104K	680.2100.01
C220	CC 100NF+-10%50V5K1200VIE CAPACITOR	CC 084.5350	UNION CARB	CK05BX104K	680.2100.01
C221	CC 100NF+-10%50V5K1200VIE CAPACITOR	CC 084.5350	UNION CARB	CK05BX104K	680.2100.01
C222	CC 100NF+-10%50V5K1200VIE CAPACITOR	CC 084.5350	UNION CARB	CK05BX104K	680.2100.01
C223	CC 100NF+-10%50V5K1200VIE CAPACITOR	CC 084.5350	UNION CARB	CK05BX104K	680.2100.01
C224	CC 100NF+-10%50V5K1200VIE CAPACITOR	CC 084.5350	UNION CARB	CK05BX104K	680.2100.01
C225	CC 100NF+-10%50V5K1200VIE CAPACITOR	CC 084.5350	UNION CARB	CK05BX104K	680.2100.01
C226	CC 100NF+-10%50V5K1200VIE CAPACITOR	CC 084.5350	UNION CARB	CK05BX104K	680.2100.01
C227	CC 100NF+-10%50V5K1200VIE CAPACITOR	CC 084.5350	UNION CARB	CK05BX104K	680.2100.01
C229	CC 10NF+-10%100V5K1200VIE CERAMIC CAPACITOR	CC 068.4060	UNION CARB	CK05BX103K	680.2100.01
C230	CK 1UF+-10%50V5RM MKT CAPACITOR	CK 099.2998	WIMA	MKS2/50/1UF/10%	680.2100.01
..238					
C239	CC 100NF+-10%50V5K1200VIE CAPACITOR	CC 084.5350	UNION CARB	CK05BX104K	680.2100.01
C240	CC 100NF+-10%50V5K1200VIE CAPACITOR	CC 084.5350	UNION CARB	CK05BX104K	680.2100.01
C241	CC 100NF+-10%50V5K1200VIE CAPACITOR	CC 084.5350	UNION CARB	CK05BX104K	680.2100.01

ROHDE & SCHWARZ	AI	Datum Date	Schaltteilliste für Parts list for	Sachnummer Stock Nr.	Blatt Page
		17.12.89	FK852P7 EMC-FILTER	680.2069.01 SA	3+

Für diese Unterlage behalten wir uns alle Rechte vor

Kennz. Comp.No.	Benennung Designation	Sachnummer Stock No.	Hersteller Manufacturer	Bezeichnung Designation	enthalten in contained in
C242	CC 100NF+-10%50V5K1200VIE CAPACITOR	CC 084.5350	UNION CARB	CK05BX104K	680.2100.01
C243	CC 100NF+-10%50V5K1200VIE CAPACITOR	CC 084.5350	UNION CARB	CK05BX104K	680.2100.01
C244	CC 100NF+-10%50V5K1200VIE CAPACITOR	CC 084.5350	UNION CARB	CK05BX104K	680.2100.01
C245	CC 10NF+-10%100V5K1200VIE CERAMIC CAPACITOR	CC 068.4060	UNION CARB	CK05BX103K	680.2100.01
C246	CC 100NF+-10%50V5K1200VIE CAPACITOR	CC 084.5350	UNION CARB	CK05BX104K	680.2100.01
C247	CC 100NF+-10%50V5K1200VIE CAPACITOR	CC 084.5350	UNION CARB	CK05BX104K	680.2100.01
C248	CC 100NF+-10%50V5K1200VIE CAPACITOR	CC 084.5350	UNION CARB	CK05BX104K	680.2100.01
C249	CC 100NF+-10%50V5K1200VIE CAPACITOR	CC 084.5350	UNION CARB	CK05BX104K	680.2100.01
C250	CC 10NF+-10%100V5K1200VIE CERAMIC CAPACITOR	CC 068.4060	UNION CARB	CK05BX103K	680.2100.01
C251	CC 100NF+-10%50V5K1200VIE CAPACITOR	CC 084.5350	UNION CARB	CK05BX104K	680.2100.01
C252	CC 10NF+-10%100V5K1200VIE CERAMIC CAPACITOR	CC 068.4060	UNION CARB	CK05BX103K	680.2100.01
C253	CC 100NF+-10%50V5K1200VIE CAPACITOR	CC 084.5350	UNION CARB	CK05BX104K	680.2100.01
C254	CC 1NF+-10%200V5K1200VIEL CAPACITOR	CC 068.4047	UNION CARB	CK05BX102K	680.2100.01
C255	CC 1NF+-10%200V5K1200VIEL CAPACITOR	CC 068.4047	UNION CARB	CK05BX102K	680.2100.01
C256	CC 1NF+-10%200V5K1200VIEL CAPACITOR	CC 068.4047	UNION CARB	CK05BX102K	680.2100.01
C257	CC 1NF+-10%200V5K1200VIEL CAPACITOR	CC 068.4047	UNION CARB	CK05BX102K	680.2100.01
C258	CC 1NF+-10%200V5K1200VIEL CAPACITOR	CC 068.4047	UNION CARB	CK05BX102K	680.2100.01
C259	CC 1NF+-10%200V5K1200VIEL CAPACITOR	CC 068.4047	UNION CARB	CK05BX102K	680.2100.01
C260	CC 1NF+-10%200V5K1200VIEL CAPACITOR	CC 068.4047	UNION CARB	CK05BX102K	680.2100.01
C261	CC 1NF+-10%200V5K1200VIEL CAPACITOR	CC 068.4047	UNION CARB	CK05BX102K	680.2100.01
..264					
C265	CC 1NF+-10%200V5K1200VIEL CAPACITOR	CC 068.4047	UNION CARB	CK05BX102K	680.2100.01
C266	CC 100NF+-10%50V5K1200VIE CAPACITOR	CC 084.5350	UNION CARB	CK05BX104K	680.2100.01
C267	CC 100NF+-10%100V K1200VI CERAMIC CAPACITOR	060.1149	UNION CARB	CK06BX104K	680.2100.01
C268	CC 100NF+-10%50V5K1200VIE CAPACITOR	CC 084.5350	UNION CARB	CK05BX104K	680.2100.01
C269	CC 100NF+-10%100V K1200VI CERAMIC CAPACITOR	060.1149	UNION CARB	CK06BX104K	680.2100.01
C270	CC 100NF+-10%50V5K1200VIE CAPACITOR	CC 084.5350	UNION CARB	CK05BX104K	680.2100.01
C271	CC 10NF+-10%100V5K1200VIE CERAMIC CAPACITOR	CC 068.4060	UNION CARB	CK05BX103K	680.2100.01
C273	CC 100NF+-10%50V5K1200VIE CAPACITOR	CC 084.5350	UNION CARB	CK05BX104K	680.2100.01
C274	CC 10NF+-10%100V5K1200VIE CERAMIC CAPACITOR	CC 068.4060	UNION CARB	CK05BX103K	680.2100.01
C275	CC 10NF+-10%100V5K1200VIE CERAMIC CAPACITOR	CC 068.4060	UNION CARB	CK05BX103K	680.2100.01
C276	CC 10NF+-10%100V5K1200VIE CERAMIC CAPACITOR	CC 068.4060	UNION CARB	CK05BX103K	680.2100.01
C277	CC 10NF+-10%100V5K1200VIE CERAMIC CAPACITOR	CC 068.4060	UNION CARB	CK05BX103K	680.2100.01
C278	CC 10NF+-10%100V5K1200VIE CERAMIC CAPACITOR	CC 068.4060	UNION CARB	CK05BX103K	680.2100.01
C279	CC 10NF+-10%100V5K1200VIE CERAMIC CAPACITOR	CC 068.4060	UNION CARB	CK05BX103K	680.2100.01
C280	CC 10NF+-10%100V5K1200VIE CERAMIC CAPACITOR	CC 068.4060	UNION CARB	CK05BX103K	680.2100.01
C281	CC 100NF+-10%50V5K1200VIE CAPACITOR	CC 084.5350	UNION CARB	CK05BX104K	680.2100.01
C282	CC 10NF+-10%100V5K1200VIE CERAMIC CAPACITOR	CC 068.4060	UNION CARB	CK05BX103K	680.2100.01
C283	CC 100NF+-10%50V5K1200VIE CAPACITOR	CC 084.5350	UNION CARB	CK05BX104K	680.2100.01
C284	CC 100NF+-10%100V K1200VI CERAMIC CAPACITOR	060.1149	UNION CARB	CK06BX104K	680.2100.01

ROHDE & SCHWARZ	Äl	Datum Date	Schaltteilliste für Parts list for	Sachnummer Stock Nr.	Blatt Page
		17 1289	FK852P7 EMC-FILTER	680.2069.01 SA	4+

Für diese Unterlage behalten wir uns alle Rechte vor

Kennz. Comp.No	Benennung Designation	Sachnummer Stock No.	Hersteller Manufacturer	Bezeichnung Designation	enthalten in contained in
C286	CC 100NF+-10%100V K1200VI CERAMIC CAPACITOR	060.1149	UNION CARB	CK06BX104K	680.2100.01
C287	CC 100NF+-10%100V K1200VI CERAMIC CAPACITOR	060.1149	UNION CARB	CK06BX104K	680.2100.01
C288	CC 100NF+-10%100V K1200VI CERAMIC CAPACITOR	060.1149	UNION CARB	CK06BX104K	680.2100.01
C289	CC 100NF+-10%50V5K1200VIE CAPACITOR	CC 084.5350	UNION CARB	CK05BX104K	680.2100.01
C290	CC 100NF+-10%50V5K1200VIE CAPACITOR	CC 084.5350	UNION CARB	CK05BX104K	680.2100.01
C291	CC 100NF+-10%50V5K1200VIE CAPACITOR	CC 084.5350	UNION CARB	CK05BX104K	680.2100.01
C292	CC 100NF+-10%50V5K1200VIE CAPACITOR	CC 084.5350	UNION CARB	CK05BX104K	680.2100.01
C293	CC 100NF+-10%50V5K1200VIE CAPACITOR	CC 084.5350	UNION CARB	CK05BX104K	680.2100.01
C294	CC 100NF+-10%50V5K1200VIE CAPACITOR	CC 084.5350	UNION CARB	CK05BX104K	680.2100.01
C295	CC 100NF+-10%50V5K1200VIE CAPACITOR	CC 084.5350	UNION CARB	CK05BX104K	680.2100.01
C296	CC 100NF+-10%50V5K1200VIE CAPACITOR	CC 084.5350	UNION CARB	CK05BX104K	680.2100.01
C297	CC 100NF+-10%50V5K1200VIE CAPACITOR	CC 084.5350	UNION CARB	CK05BX104K	680.2100.01
C299	CC 100NF+-10%50V5K1200VIE CAPACITOR	CC 084.5350	UNION CARB	CK05BX104K	680.2100.01
C300	CC 100NF+-10%50V5K1200VIE CAPACITOR	CC 084.5350	UNION CARB	CK05BX104K	680.2100.01
C301	CC 100NF+-10%50V5K1200VIE CAPACITOR	CC 084.5350	UNION CARB	CK05BX104K	680.2100.01
C302	CC 100NF+-10%50V5K1200VIE CAPACITOR	CC 084.5350	UNION CARB	CK05BX104K	680.2100.01
C303	CC 100NF+-10%50V5K1200VIE CAPACITOR	CC 084.5350	UNION CARB	CK05BX104K	680.2100.01
C304	CC 100NF+-10%50V5K1200VIE CAPACITOR	CC 084.5350	UNION CARB	CK05BX104K	680.2100.01
C305	CC 100NF+-10%50V5K1200VIE CAPACITOR	CC 084.5350	UNION CARB	CK05BX104K	680.2100.01
C306	CC 10NF+-10%100V5K1200VIE CERAMIC CAPACITOR	CC 068.4060	UNION CARB	CK05BX103K	680.2100.01
C307	CC 10NF+-10%100V5K1200VIE CERAMIC CAPACITOR	CC 068.4060	UNION CARB	CK05BX103K	680.2100.01
D1	BL MM74C374N 8XD-FLIPFL D-FLIPFLOP	347.4240	NSC	MM74C374N	680.2100.01
D2	BL MM74C374N 8XD-FLIPFL D-FLIPFLOP	347.4240	NSC	MM74C374N	680.2100.01
D3	BL CD4081BE 4X2INP.ANDG AND GATE	299.6872	RCA	CD4081BE	680.2100.01
D4	BL MC14538BCP 2X MONOFLOP MONOSTABLE MULTIVIBRATOR	252.7389	MOTOROLA	MC14538BCP	680.2100.01
D5	BL CD4071BE 4X2IN. ORG OR GATE	299.6866	RCA	CD4071BE	680.2100.01
D6	BL CD4013BE 2XD- FLIPFL FLIPFLOP	086.7021	RCA	CD4013BE	680.2100.01
D7	BL MM74HC14N 6XINV.SCHM HEX INV.SCHMITT TRIGGER	BL 099.9492	NSC	MM74HC14N	680.2100.01
F1	SS SCHMELZS.M4 E DIN41571 FUSE	SS 020.7598	WICKMANN	M4EDIN41571TROP	680.2100.01
F2	SS SCHMELZS.M2 E DIN41571 FUSE	SS 020.7523	WICKMANN	M2EDIN41571TROP.	680.2100.01
F3	SS SCHMELZS.M250CDIN41571 FUSE	SS 020.7269	WICKMANN	MO,25CDIN41571TROP.	680.2100.01
F4	SS SCHMELZS.M800CDIN41571 FUSE	SS 020.7400	WICKMANN	MO,8CDIN41571TROP	680.2100.01
F5	SS SCHMELZS.M250CDIN41571 FUSE	SS 020.7269	WICKMANN	MO,25CDIN41571TROP.	680.2100.01
L1	LD 100 UH10%8,000HMO,084A CHOKE	LD 067.3101	DELEVAN	DROSSEL1025-68	680.2100.01
L29	LD 8U 1,5A 0,160HM CHOKE	007.7317	SIEMENS	B82132-A5152-M	680.2100.01
L30	LD 25UH 3A 0,0460HM CHOKE	LD 026.4849	SIEMENS	B82111-B-C24	680.2100.01
L34	LD 15UH 4A 0,0240HM CHOKE	LD 026.4832	SIEMENS	B82111-B-C23	680.2100.01

ROHDE & SCHWARZ	Al	Datum	Schaltteilliste für	Sachnummer	Blatt
	17	1289	Parts list for	Stock Nr.	Page
			FK852P7 EMC-FILTER	680.2069.01 SA	5+

Für diese Unterlage behalten wir uns alle Rechte vor

Kennz. Comp.No.	Benennung Designation	Sachnummer Stock No.	Hersteller Manufacturer	Bezeichnung Designation	enthalten in contained in
L35	LD 15UH 4A 0,0240HM CHOKE	LD 026.4832	SIEMENS	B82111-B-C23	680.2100.01
L36	LD 25UH 3A 0,0460HM CHOKE	LD 026.4849	SIEMENS	B82111-B-C24	680.2100.01
L37	LD 25UH 3A 0,0460HM CHOKE	LD 026.4849	SIEMENS	B82111-B-C24	680.2100.01
L38	LD 25UH 3A 0,0460HM CHOKE	LD 026.4849	SIEMENS	B82111-B-C24	680.2100.01
L39 ..71	LD 100 UH10%8,000HMO,084A CHOKE	LD 067.3101	DELEVAN	DROSSEL 1025-68	680.2100.01
L73 ..84	LD 100 UH10%8,000HMO,084A CHOKE	LD 067.3101	DELEVAN	DROSSEL 1025-68	680.2100.01
L86 ..97	LD 100 UH10%8,000HMO,084A CHOKE	LD 067.3101	DELEVAN	DROSSEL 1025-68	680.2100.01
L99 ..105	LD 100 UH10%8,000HMO,084A CHOKE	LD 067.3101	DELEVAN	DROSSEL 1025-68	680.2100.01
L106	LD 8U 1,5A 0,160HM CHOKE	007.7317	SIEMENS	B82132-A5152-M	680.2100.01
L107	LD 8U 1,5A 0,160HM CHOKE	007.7317	SIEMENS	B82132-A5152-M	680.2100.01
R54 ..65	RK VARISTOR 14VO,1MAO,01W VARISTOR	645.7122	SIEMENS	SIOV-S05K14	680.2100.01
R108 ..117	RL 0,35W 4,75KOHM+-1%TK50 RESISTOR	RL 083.1097	DRALORIC	SMA0207/4,75K-F-D	680.2100.01
R118	RL 0,35W 47,5KOHM+-1%TK50 RESISTOR	RL 083.1800	DRALORIC	SMA/207/47,5K-F-C	680.2100.01
R119	RL 0,35W 47,5KOHM+-1%TK50 RESISTOR	RL 083.1800	DRALORIC	SMA/207/47,5K-F-C	680.2100.01
R209	RL 0,35W 10,0KOHM+-1%TK50 RESISTOR	RL 083.1297	DRALORIC	SMA0207/10K-F-D	680.2100.01
R210	RL 0,35W 10,0KOHM+-1%TK50 RESISTOR	RL 083.1297	DRALORIC	SMA0207/10K-F-D	680.2100.01
R211	RL 0,35W 10,0KOHM+-1%TK50 RESISTOR	RL 083.1297	DRALORIC	SMA0207/10K-F-D	680.2100.01
R220	RL 0,35W 10,0KOHM+-1%TK50 RESISTOR	RL 083.1297	DRALORIC	SMA0207/10K-F-D	680.2100.01
R224	RL 0,35W 10,0KOHM+-1%TK50 RESISTOR	RL 083.1297	DRALORIC	SMA0207/10K-F-D	680.2100.01
R225	RL 0,35W 10,0KOHM+-1%TK50 RESISTOR	RL 083.1297	DRALORIC	SMA0207/10K-F-D	680.2100.01
R227	RL 0,35W 10,0KOHM+-1%TK50 RESISTOR	RL 083.1297	DRALORIC	SMA0207/10K-F-D	680.2100.01
R301 ..308	RL 0,35W 100 OHM+-1%TK50 RESISTOR	RL 082.6543	DRALORIC	SMA0207/100/HM-F-D	680.2100.01
T1 ..4	LU NF 0,2-20KHZ/2DB TRANSFORMER	586.7932	HAUFE	R&S-ZCHNG. 586.7932	680.2100.01
W2	DX HF-KABEL W2	680.2269			
W3	DX HF-KABEL W3	680.2275			
W16	DX HF-KABEL W16	680.2281			
W73	DX FLACHLEITUNG 10-POL.	680.2298			680.2100.01
W74	DX FLACHLEITUNG 34-POL.	680.2300			680.2100.01
X2	FM BUCHSENLEISTE 37P.WRAP CONNECTOR 37POL.	FM 680.2369	FCT	F37S4	680.2100.01
X3	FM BUCHSENLEISTE 25P.WRAP CONNECTOR 25P.	FM 680.2375	FCT	F25S.4	680.2100.01
X4	FM STECKERLEISTE 37P 37-PIN INSERT	FM 454.9268	FCT	F37P4	680.2100.01
X5	FM BUCHSENLEISTE 37P.WRAP CONNECTOR 37POL.	FM 680.2369	FCT	F37S4	680.2100.01
X6	FM STECKERLEISTE 25P.WRAP CONNECTOR 25P.	FM 680.2381	FCT	F25P4	680.2100.01
X7	FJ UEBERGANG BNC-BUSMB-ST ADAPTER	FJ 080.2270	ROSENBERGE	59 S 551-K00	
X71	FP STECKERLEISTE 20P.WIN# CONNECTOR 20P	FP 620.0447	PANDUIT	050-020-033B	680.2100.01
X72	FP STECKERLEISTE 64P.WIN# CONNECTOR 64P	FP 645.7522	BERG	76798-164	680.2100.01
Z1 ..7	LD 10GHZ 50DB100V10A4RDX9 LEAD THROUGH FILTER	LD 451.4636	OXLEY	SLT5/P/2000/REF.1	680.2100.01

- ENDE -

ROHDE & SCHWARZ	AI	Datum	Schaltteilliste für Parts list for	Sachnummer Stock Nr.	Blatt Page
		Date			
	17	1289	FK852P7 EMC-FILTER	680.2069.01 SA	6-